

# The Daily Edition

50¢

Serving Loudon, Monroe and Surrounding Counties

Monday, December 28, 2015

## First Degree Murder in LC because victim wouldn't leave

On Christmas Evening Deputy Kevin Dailey, LCSO on 12/24/15 dispatched to 300 Clinch View Road Lenoir City in reference to a shooting around 821am. Upon arrival Officer Dailey saw a large white male identified as victim Cory Brown lying on the ground. Standing near Mr. Brown was Ronald Wallace Griz-

zle on the phone. As the officer approached he asked where the shooter was and he said in the house. The officer observed the suspect Ronald Gregory Grizzle coming out of the house and held him at gunpoint. Mr. Grizzle was taken into custody at that time and investigators were called in to handle the investigation. Mr. Ronald Gregory Griz-

zle did not confirm nor deny involvement at that time.

Investigators arrived on the scene and the suspect, Mr. Ronald Gregory Grizzle was in custody and investigators, Charles Cosner, Jeff Russell, Jason Smith and Lt. Patrick Upton handled the investigation. According to witnesses (see Murder pg. 4)

## Federal Jury Convicts North Carolina couple of fraud

Husband and wife conspired to defraud federal contract programs for disadvantaged and disabled veteran-owned small businesses

Following a 13-day trial in U.S. District Court, a jury convicted Ricky Anthony Lanier, 48, and his wife Katrina Reshina Lanier, 43, both of La-Grange, N.C., of conspiracy to commit wire fraud, wire fraud, and major fraud against the United States.

(see fraud pg. 3)

## Stopped after returning from methadone clinic



Jennifer Archer

(see clinic pg. 7)

## Home Federal Bank Robber in Custody

On Tuesday, 12/21/2015, law enforcement agencies responded to a bank robbery at the Home Federal Bank at 3101 North Broadway, Knoxville, TN.

Reports indicate that at approximately 9:30 a.m., a lone white male entered the Home Federal Bank and demanded money. After obtaining an undisclosed

amount of money from the bank, the robber fled on foot.

Samuel Manning, age 45, of Knoxville, was located shortly thereafter and was detained by uniformed officers of the Knoxville Police Department. Manning was subsequently arrested without incident.

Manning was charged by Criminal (see robber pg. 5)

## Hit and run driver nabbed after fleeing scene



Samantha Curtis

(see hit and run pg. 2)

### Verse of the Day

For God so loved the world that he gave his one and only Son, that whoever believes in him shall not perish but have eternal life. — John 3:16

### Obituaries

see inside **Wazzup**

It's getting ready to be the end of 2015. Definitely looking forward to a great New Year in 2016!

### Weather

Today: Overcast with rain showers at times. Thunder possible. High 74F. Tonight: Thunderstorms during the evening followed by occasional showers overnight. Low around 55F.

Tuesday Sunshine and clouds mixed. High 63F. Tuesday Night Partly cloudy skies early will give way to cloudy skies and rain later during the night. Low 49F.

### Horoscopes

(Continued on page 6)



3 08805 93489 2

**hit and run**

Samatha Curtis, 39, Mulberry Street Loudon, was charged with Driving on Revoked/Suspended License, and Leaving the Scene of an Accident with Property Damage.

According to the report, Officer Dennis Guider LCPD, was dispatched to a hit and run on Broadway at K Street. The vehicle that left

the scene was located and stopped by Deputy Bobby Hamilton LCSO, at Hwy 11 and Sugarlimb Road.

The driver was identified as Samantha Curtis, who was placed under arrest. Officer Dennis Guider LCPD, made the arrest.

**Dependable Motors**  
865-986-9343

**Call 865-771-2249 to Advertise and start saving today!**  
**Has your group got an event coming up?**  
**Let us know!!!**

**Notice**

Reward offered for the return of a handmade black walnut baby cradle and 700 strands of African trade beads stolen from our home. If you have any information please call 865-250-9280.

Notice: The Daily Edition does not knowingly accept fraudulent or misleading materials. The Daily Edition cannot guarantee the validity of offerings or statements contained herein. All liability for the contents of all advertising, and for any claims that may arise therefrom, is the responsibility of the advertiser or its agency. The Daily Edition reserves the right to reject, edit, or abbreviate any advertisement submitted. Advertising is accepted with the understanding that all liability for all copyright violations is the sole responsibility of the advertiser.

Photographs, artwork and other copy submitted for publication is considered the sole property of the advertiser. The Daily Edition will make every effort but will not be liable for failure to publish and ad or for typographical and layout errors. All statements and information about highlights featured items, letters to the editor, herein are those solely given to the interviewer or writer and the Daily Edition assumes no responsibility of the accuracy or validity thereof. The Daily Edition will gladly reprint at no charge that part of an advertisement in which an error occurs provided a claim is made within 3 days of the first publication of the ad. Information contained in the Wazzup is received anonymously and the Daily Edition assumes no responsibility for information and reserves the right to edit or reject any and/or all submissions. The Daily Edition is a daily newspaper of general circulation in Loudon County defined under TCA 2-1-104(a)(13).

The Daily Edition also serves Monroe, Knox, Anderson, Roane and Blount counties and serves 30,000 readers weekly. Send mail to PO Box 1240, Lenoir City TN 37771. 865-771-2249. email: dan1204us@yahoo.com

The Daily Edition is Loudon County's premier public interest and paid advertising paper. The Daily Edition is produced and published daily Monday through Friday and is circulated throughout Loudon County and parts of Monroe and Knox Counties. Display advertising rates \$5.00 per column inch and quantity discounts available. Call for information on upcoming promotions and events.

**HACIENDA Ayala's**  
**Mexican Restaurant**  
Market Dr. \* Lenoir City (In Front of Food City)

**Real Authentic Mexican Food at Affordable Prices**

**BEST MARGARITA**

You've Tried The Rest Now Come Have The Best!!!

We Accept ALL Competitors Coupons Outside of Mexico City!

986-3553

**Good Credit OK • Bad Credit OK • Bankruptcies OK • Repo OK**



2010 Kia Soul Sporty, 4 cyl, Auto, PW, PL, A/C, Great On Gas, Like New



2010 Ford Escape Limited Leather, Alloy Wheels, Heat, A/C, Luggage Rack, 79K,



2007 Dodge Ram 1500 Quad Cab, Thunder Road PKG, 20 in. Wheels, Low Miles, Hemi



2008 Ford Explorer 84k, 3rd Row Seating, Luggage Rack, Tow Pkg, PW, PL



2011 Ford Ranger Low Miles, Tow Pkg, New Tires, A/C, Heat, Bed Liner.



2011 Dodge Grand Caravan DVD, Stow & Go, Loaded, Remote Doors, Rear A/C

**DEPENDABLE MOTORS 986-9343**

803 E. Broadway • Lenoir City

Serving Loudon County for 20 Years

\* WAC. See Dealer for details

Visit our website at: [www.dependablemotorslc.com](http://www.dependablemotorslc.com)

fraud

Sentencing is set for 9:00 a.m., on June 20, 2016, in U.S. District Court in Greeneville. Ricky Lanier faces a possible sentence of up to 60 years in prison and \$1 million in fines; Katrina Lanier faces a possible sentence of up to

50 years in prison and \$750,000 in fines. The Laniers agreed to forfeit their interests in approximately \$170,000 in funds seized from bank accounts as well as five houses in Kinston, N.C., purchased with proceeds of the fraud.

According to the evidence presented at trial, the Laniers conspired from November 2005 to April 2013 to defraud the United States government through a scheme to fraudulently obtain federal contracts intended to be awarded to businesses lawfully participating in the Department of Veterans Affairs' (VA) Service-Disabled Veteran-Owned Small Business (SDVOSB) program and the Small Business Administration's (SBA) 8(a) Business Development program. The scheme involved false representations that JMR Investments was eligible as an 8(a) business

and that Kylee Construction was eligible as an SDVOSB and an 8(a) business. Ricky Lanier, who had previously owned and operated an 8(a) business receiving government contracts, became ineligible to participate in the 8(a) program after that business graduated from the 8(a) program in 2008. Lanier used a friend and service-disabled veteran as the purported owner of Kylee Construction, representing that the friend was involved

in the daily management of the business, even while the friend was working for a government contractor in Afghanistan. The Laniers used a business owned by Ricky Lanier's college roommate, JMR Investments, as a front to obtain construction contracts from the National Park Service and other federal agencies under the 8(a) program, misrepresenting the friend's involvement in the management and

(see fraud ctd. pg. 7)

**For Sale: oak Wood Mulch**



Mushroom Compost Topsoil.



Firewood

Call Steve Spoon  
986-4282

**West End Storage & Warehouses**  
502 Ward Avenue • Loudon  
Call 865-458-4774 or 865-679-5555

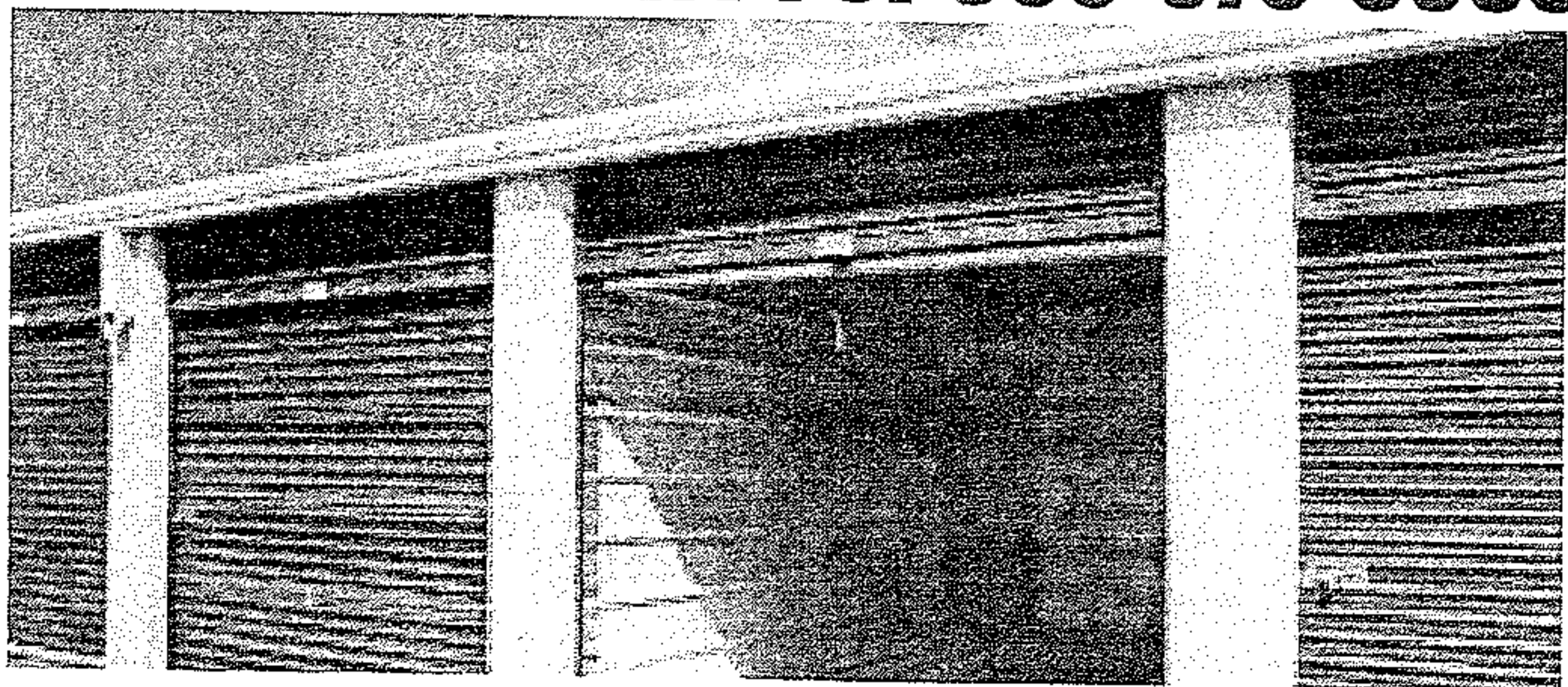

**STAINED INC.**

**TATTOO & PIERCING**  
LENOIR CITY 865 816-6440  
NEW OWNER • NEW ARTIST • SINCE 2011  
521 Hwy 321 next to Vape & Stuff & Inn Of Lenoir!  
Clean-Affordable-Quality-Custom  
Tattoo's You've Always Wanted!

BRING IN THIS Ad FOR **\$25 OFF!**  
NEW INK FOR NEW CUSTOMERS ONLY!

Check us out on FB.com/  
Stained.Inc.Tattoo/  
www.STAINEDINC.com

**C&J Towing and Recovery**

**LOWEST TOWING RATES AROUND!!!**

Have you been overcharged for any type of towing service in the Lenoir City area? If you have a breakdown or accident please OWNER REQUEST C&J Towing with the officer. Also please call your Sheriff and ask him to place C&J Towing on the "Rotation List\*" and help other motorists save as much as you did! We at C&J are locally owned and operated, State approved, licensed, bonded and insured. Call and let us know if your denied service or how we can be of assistance.

\*note: the "Rotation List" is a list of wrecker services that provide service for wrecks, DUI's, breakdowns, etc. and are on an on-call basis for service. This list is approved by the Sheriff.

Cliff Teeters • Owner  
865-809-1661

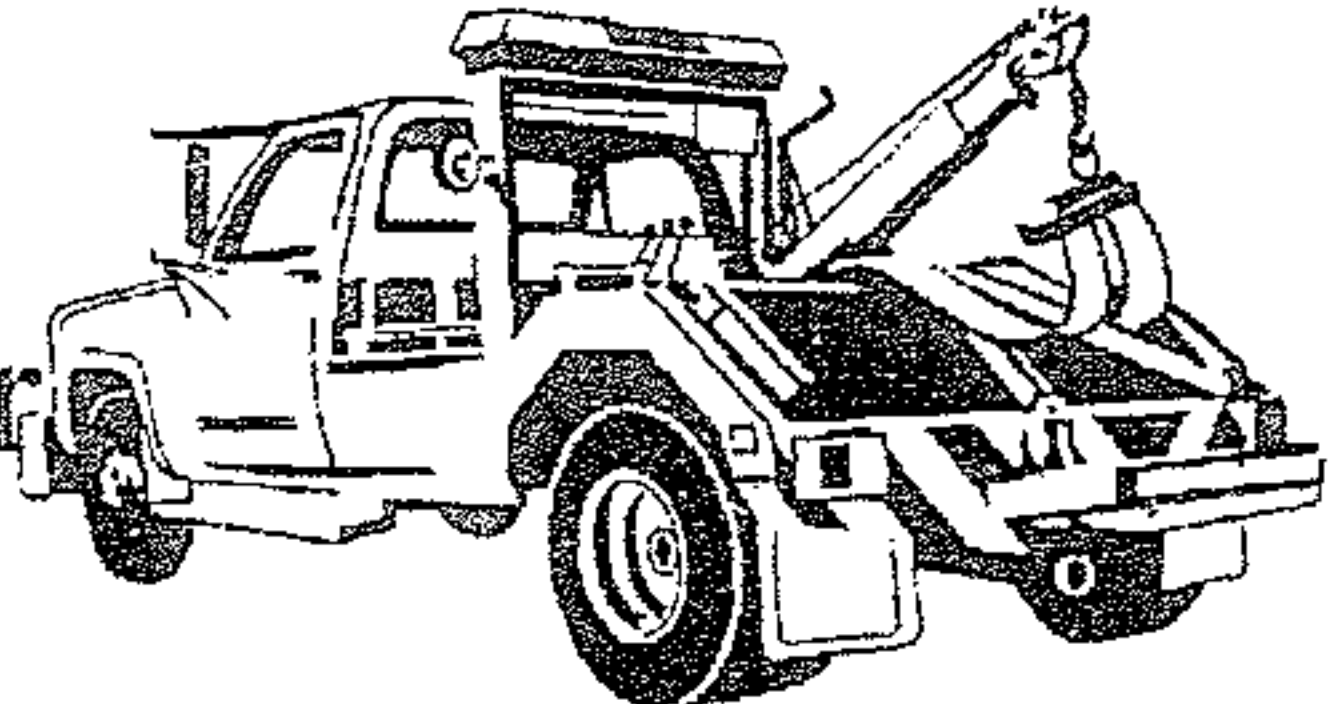

**BIMBO'S**

Deli Open 24 Hours  
865-986-9643 Call Ins Welcome

Specials

Lg. Cold Sub, bag of chips and 16 oz. fountain drink  
only \$6.29

Footlong Corn Dog \$2.59

**murder** and the investigation of the scene; two guns were recovered and those weapons were identified as belonging to Ronald Gregory Grizzle. 2 shell casings were also recovered. After investigation of victim it was determined the victim had been shot twice once on the left side of victim's face, and another shot is believed to have penetrated the shoulder area.

Mr. Ronald Gregory Grizzle was interviewed briefly at the scene by Lt. Upton and stated he was the shooter and shot Mr. Brown because he would not leave the residence. Upon later interview at the station with Lt. Upton and Investigator

Jeff Russell, Grizzle admitted again he was the shooter and was upset for the last two days after attempting to get Cory Brown to leave the property.

The investigation revealed Ronald Gregory Grizzle left his house and went to a camper trailer where Cory Brown was staying. Mr. Grizzle leaves Cory's camper goes back to his residence and retrieves two handguns, and returns to Cory's camper. Mr. Grizzle reported he remembers shooting Mr. Brown at least one time while he sat on the sofa. Further questioning revealed Mr. Brown did not provoke, threaten or come at the shooter. It was also revealed the

victim was even unable to have defended himself.

The father of the shooter Ronald Wallace Grizzle was interviewed and stated his son was upset about Cory Brown not leaving. The father stated when he saw his son get the two guns to go back to the camper he tried to stop him then but was unable to do so. After the shooting the father retrieved the guns from his son and showed officers where they were located upon their arrival.

The victim was able to make a recording after being shot before his death that will be used as evidence as well.

Upon consulting the office of District Attorney General Russell

Johnson it was agreed the murder was premeditated and should be a first degree murder charge. Therefore Ronald Gregory Grizzle, 48, is charged with first degree murder. He is being held without bond and is scheduled for arraignment on Monday.

The victim Cory Brown, was 27.

Lt. Upton stated "he would like to thank all agencies involved and this is a terrible situation where two families lives have now been ruined over a senseless act. The victims mother told us her son told her he was planning on leaving in a couple of days."

**SARCO Enterprises Inc. Offers Complete Home and Commercial Remolding and Repairs**

Our Team members have a combined total of over 40 years experience in all areas of home construction, facilities maintenance and commercial construction. Roofing, Electrical, Bath and Kitchen Renovations, we do it all with just one call. We are fully insured and our work is guaranteed.

Call us today for a free no obligation quote for your next project.  
865-809-9492.

**BUDGET**  
*Transmissions*

**Why Buy From Budget?**

**Free Towing From Lenoir City or Loudon County**

**20 Years of BBB Zero Customer Complaints Award Member**

**A+ Plus Rated**

**Huge Transmission Inventory  
Best Technicians Period!!!**

**Call (865) 584-4391 Today!**

**302 S. Northshore Drive Knoxville**

**(865) 584-4391**

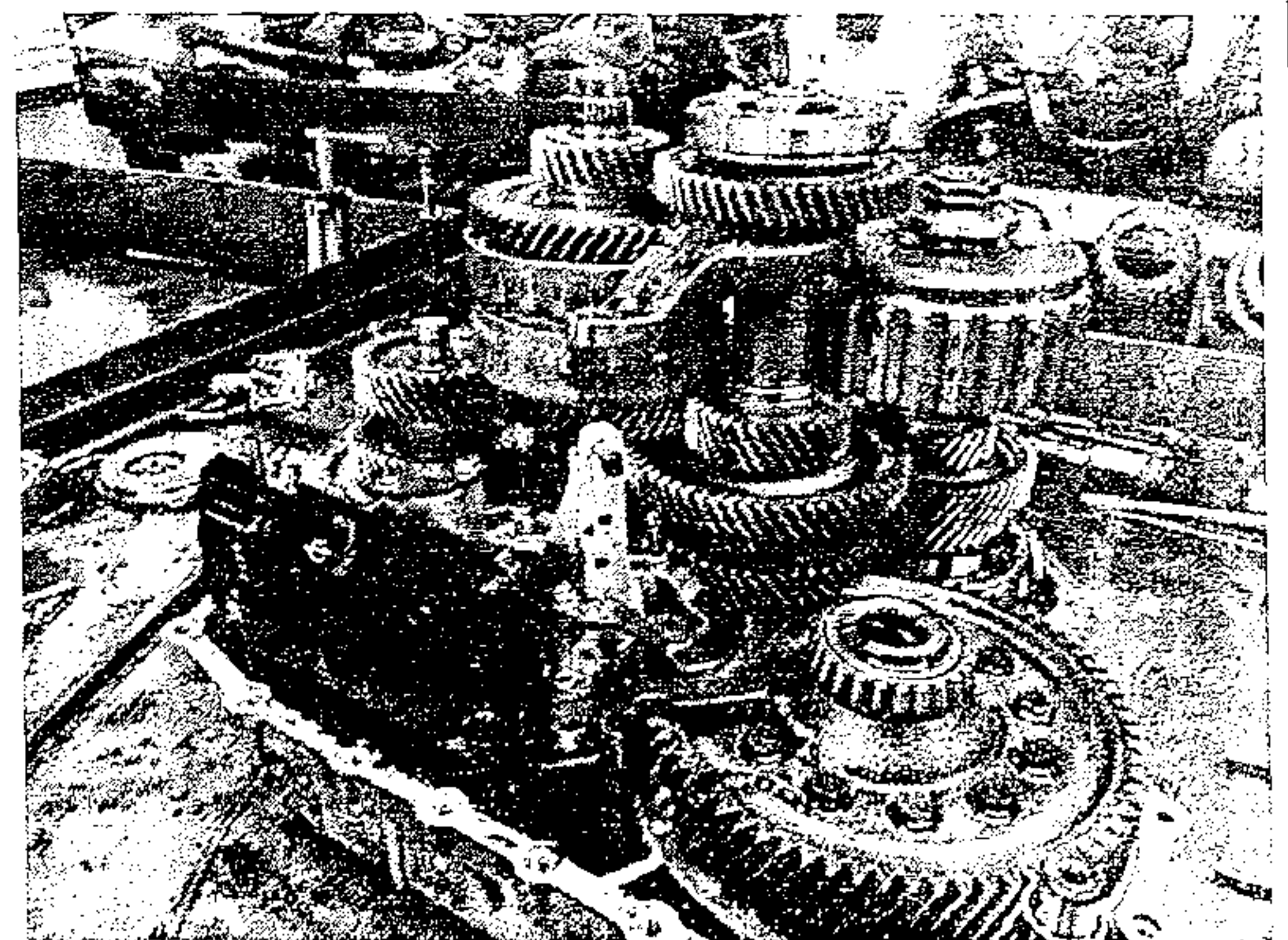

*budget-transmissions.com*



**Approved Auto Repair**



robber

Complaint with one count of bank robbery and appeared today in United States District Court for the Eastern District of Tennessee in Knoxville for an Initial Appearance. Manning was detained pending a preliminary hearing.

This matter is being investigated by the Federal Bureau of

Investigation (FBI), the Knoxville Police Department (KPD) Violent Crime Unit, KPD and the Knox County Sheriff's Office (KCSO) as part of the FBI Safe Streets Task Force (SSTF).

All defendants are presumed innocent unless or until proven guilty beyond a reasonable doubt.

Anyone with infor-

mation is asked to call the Knoxville FBI Office at 865-544-0751 or the Knoxville Police Department at 865-215-7212.

For more information on the FBI's Knoxville Division, visit [www.fbi.gov/knoxville](http://www.fbi.gov/knoxville)

Obits cont. from pg. 4

John Raymond (Ray) Satterfield  
February 2, 1943-

December 24, 2015

Ray died peacefully at his home in Philadelphia, Tennessee on Thursday, December 24, 2015 at the age of 72. He was preceded in death by his father, Benjamin Leroy Satterfield. He is survived by his wife, Marcia Gruver Shelly; his mother, Amanda Dalton Satterfield; his brother, Gary L. Satterfield (Jean); his three daughters, Laura S. Hollins (John), Karen S. Grove (Glenn) and Jen-

nifer S. Harper (Clay); his son, Gabe J. Shelly (Heather); and seven grandchildren. Ray was born in Richmond, Virginia on February 2, 1943. He was a graduate of Hermitage High School "Class of 1961" and then went to Bluefield College in West Virginia from 1961 to 1963. He graduated from Richmond Professional Institute in 1966 with a B.S. degree in Psychology. After college, he worked as a manager for DuPont for 5 years. He then went to work for Electrical Insulation Suppliers as a Sales Executive until his retirement in 2002. After 4 years of retirement, he became VP of Marketing and Sales with Motor Diagnostic Systems until his death. Ray was a great cook and loved hosting friends and family in his home. He was also an avid hunter and golfer. He was a member of the Episcopal Church of the Resurrection in Loudon, TN for the past 30 years. A visitation will be held on Wednesday, December 30, 2015 from 12 to 2PM at the Episcopal Church of the Resurrection, 917 Pond Road, Loudon, TN. A memorial service will follow the visitation. Honorary pallbearers are Al Battle, Phil Brown, Eddie Grant, George Gruver, Jack Hamilton, Ron Hipp, Greg Hoover, Woody MacDonald, Rick Nalley, Jerry Reed, Gary Satterfield and Gabe Shelly. In lieu of flowers, donations may be made to Habitat for Humanity, 308 Mialaquo Road, Loudon, TN 37774 or to the Episcopal Church of the Resurrection, 917 Pond Road, Loudon, TN 37774.

# PURDY'S AUTO PARTS AND SALVAGE

WE BUY SCRAP IRON • COPPER • BRASS • ALUMINUM

**\$** **Paying Top \$\$\$**  
Call For Latest Prices

*You Name It, We Buy It!*

*Radiators, Wheels, Batteries, Appliances, Farm Equipment*

**Copper**  
Paying Top \$\$\$  
Call For Latest Prices

**Complete Cars**  
per 100 lbs.

**Scrap Metal**  
Paying Top \$\$\$  
Call For Latest Prices  
per 100 lb

**We Buy Batteries**

**Aluminum Cans**  
Paying Top \$\$\$  
Call For Latest Prices

**You Call We Haul!**

**423-519-5402**

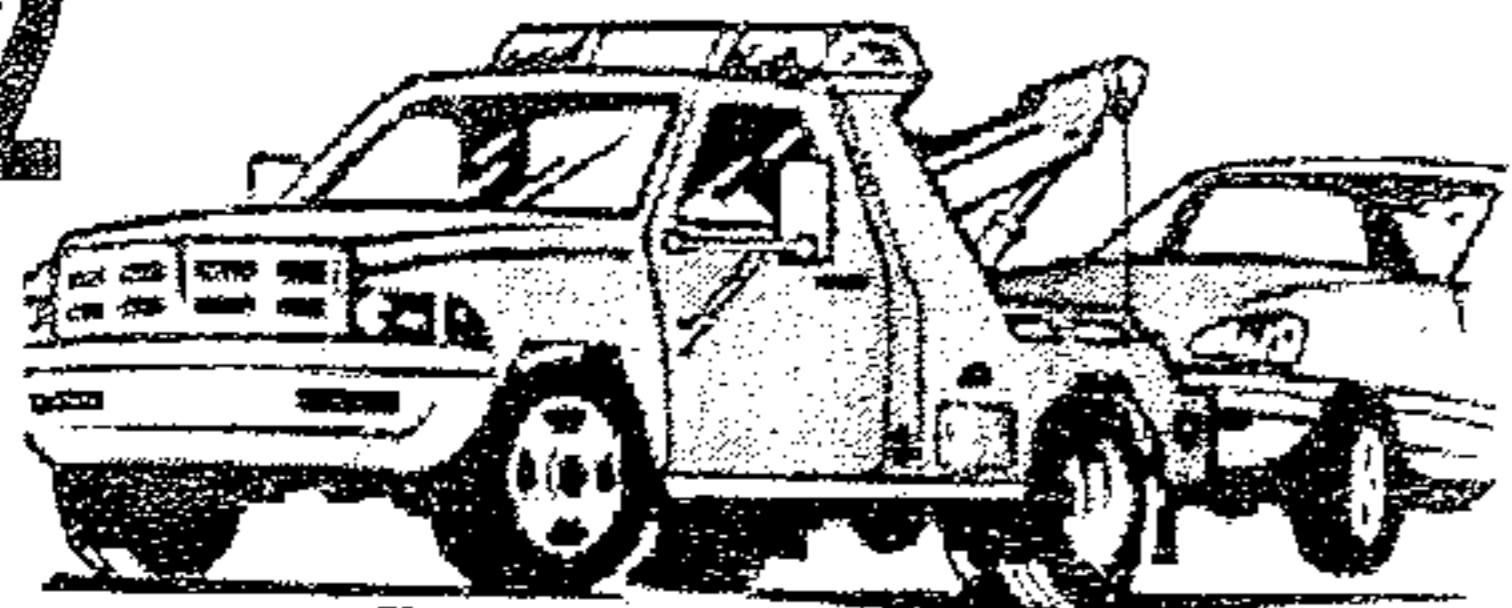

Prices subject to change with the market.

**Now Selling  
Aftermarket  
Body Parts at  
Discount Prices**

**423 337-3977**

**149 County Road 323 Sweetwater**

Prices subject to change with the market.

**clinic**

Jennifer Archer, 29, Happy Trails Way Sevierville, was charged with DUI, Driving on Revoked License, Violation of Implied Consent. Trooper J Capps THP, was dispatched a BOLO on a reckless driver speeding and swerving all over the roadway. Trooper got behind the vehicle and paced it at 85 mph in a 65 mph zone. Trooper traffic stopped the vehicle and identified the driver as Jennifer Archer, who admitted to Trooper that her license were suspended, and she was on her way home from the methodone clinic

from Georgia. Jennifer did poorly on sobriety test and was placed under arrest. Trooper J Capps, THP, made the arrest.

**fraud ctd. from pg. 3**

operation of the business. The scheme also involved sub-contracting out all or almost all of the work on the contracts in violation of program requirements. Among other contracts, Ricky Lanier defrauded the National Park Service in connection with a contract to replace a wastewater treatment facility at the Tremont Institute in the Great Smoky Mountains National Park, falsely representing that sub-contractor costs were over \$400,000 more than they actually were, resulting in the award of a contract

for \$1.1 million when all work on the project was performed by a Kodak contractor for \$550,000. Lanier also fraudulently obtained a \$1.3 million construction contract at the James H. Quillen VA Medical Center which had been set aside for SDVOSBs.

As a result of the false representations, Kylee Construction was awarded over \$5 million in government contracts and JMR Investments was awarded over \$9 million in government contracts, to include contracts for construction at the VA Medical Center at Mountain Home, Tenn., and in the Great Smoky Mountains National Park. The Laniers received almost \$2 million in financial benefit from the scheme,

using accounts of the shell companies for payment of personal expenses.

Nancy Harr, Acting U.S. Attorney for the Eastern District of Tennessee said, "The integrity of the Service-Disabled Veteran-Owned Small Business program is vital to its continued success. The U.S. Attorney's Office will aggressively pursue and prosecute those who attempt to defraud that federal program and therefore the United States."

"Consistent with Public Law 109-461, awarding contracts to Service-Disabled Veteran-Owned Small Business (SDVOSB) firms is the highest priority within the Small Business programs for VA. Today's guilty verdict is indicative of the

hard work and successful relationships between VA, DOJ, and our law enforcement partners to protect the integrity of the SDVOSB program, and deter those who attempt to defraud our government," said Special Agent in Charge Monty Stokes, VA, Office of Inspector General, Southeast Field Office.

Kevin Kupperbusch, Special Agent in Charge, SBA, Office of Inspector General (OIG), stated, "Effective partnerships among several law enforcement agencies as well as aggressive investigative efforts were key in bringing these defendants to justice. These convictions should serve as a deterrent to others who intend to take advantage of disabled military veterans

see fraud conc. pg. 8

LOOK!
\$75 Weekly Payments
LOOK!

MARTY'S AUTO SALES • 986-2222
MARTY'S AUTO SALES • 986-2222
MARTY'S AUTO SALES • 986-2222
MARTY'S AUTO SALES • 986-2222
MARTY'S AUTO SALES • 986-2222

Bad Credit

Divorce

Fixed Income

Repos

Bankruptcy

No Credit

# APPROVED!

Visit Us On The Web At:

## martyautosales.net

NO

CREDIT

CHECKS

\$499  
down\*

07 Cobalt, 5spd, gas saver,  
runs great Only \$499 down\*

\$499  
down\*

02 Sable, sunroof, loaded,  
Only \$499 down\*

\$499  
down\*

04 Cavalier, 2dr, Sporty, Only  
\$499 down\*

\$499  
down\*

01 Sebring 2dr. sporty, Only  
\$499 down\*

\$299  
down\*

00 Civic, auto, Gas Saver,  
Only \$299 down\*

\$399  
down\*

06 PT Cruiser, auto, gas saver  
Only \$399 down\*

\$399  
down\*

04 Stratus, 4 cyl, Runs good,  
Only \$399 down\*

\$99  
down\*

98 Bonneville, 6 cyl, Auto, low  
payments only \$99 down\*

NO  
Credit Checks

# Marty's

## Auto Sales

986-2222

Se Habla Español

100%  
Approval\*

\*See Dealer for details. All down payments plus tax, tag, title and fees.

MARTY'S AUTO SALES • 986-2222
MARTY'S AUTO SALES • 986-2222
MARTY'S AUTO SALES • 986-2222
MARTY'S AUTO SALES • 986-2222
MARTY'S AUTO SALES • 986-2222

fraud conc. from pg. 7 and defraud the Federal Government through its various contracting programs."

Special Agent in Charge Bill Gulsby, Department of Interior, OIG, joined in recognizing the efforts of the investigative team in protecting these important programs.

Law enforcement

agencies participating in the joint investigation which led to indictment and subsequent conviction of Ricky and Katrina Lanier included the VA, OIG; SBA, OIG; with assistance from the U.S. Secret Service. Assistant U.S. Attorneys Neil Smith and David Gunn represented the United States at trial.

### THE RELIC SHOP

521 Hwy 321 Lenoir City Suite 3  
next to Stained Inc and the Inn of Lenoir

**OFFICIALLY OPENING THIS SATURDAY  
DECEMBER 26, 2015**

WHERE A PERSON CAN BUY A PIECE OF HISTORY  
INDIAN ARTIFACTS, CIVIL WAR RELICS, FOSSILS  
ANTIQUA GUNS, ANTIQUA POCKETWATCHES,  
OLD COINS AND WHOLE LOT MORE!!!

### Is Your Washer Broken?

Call Me

I Only Charge \$100 Period!!!

Call Allen

865-617-7113

**A Name You Already Know And Trust Just Got Even More Dependable**  
**DEPENDABLE AUTO SERVICE, LUBE AND TIRES**  
**is Now Offering**  
**Expert, Affordable Transmission Service**  
All ASE Certified Technicians

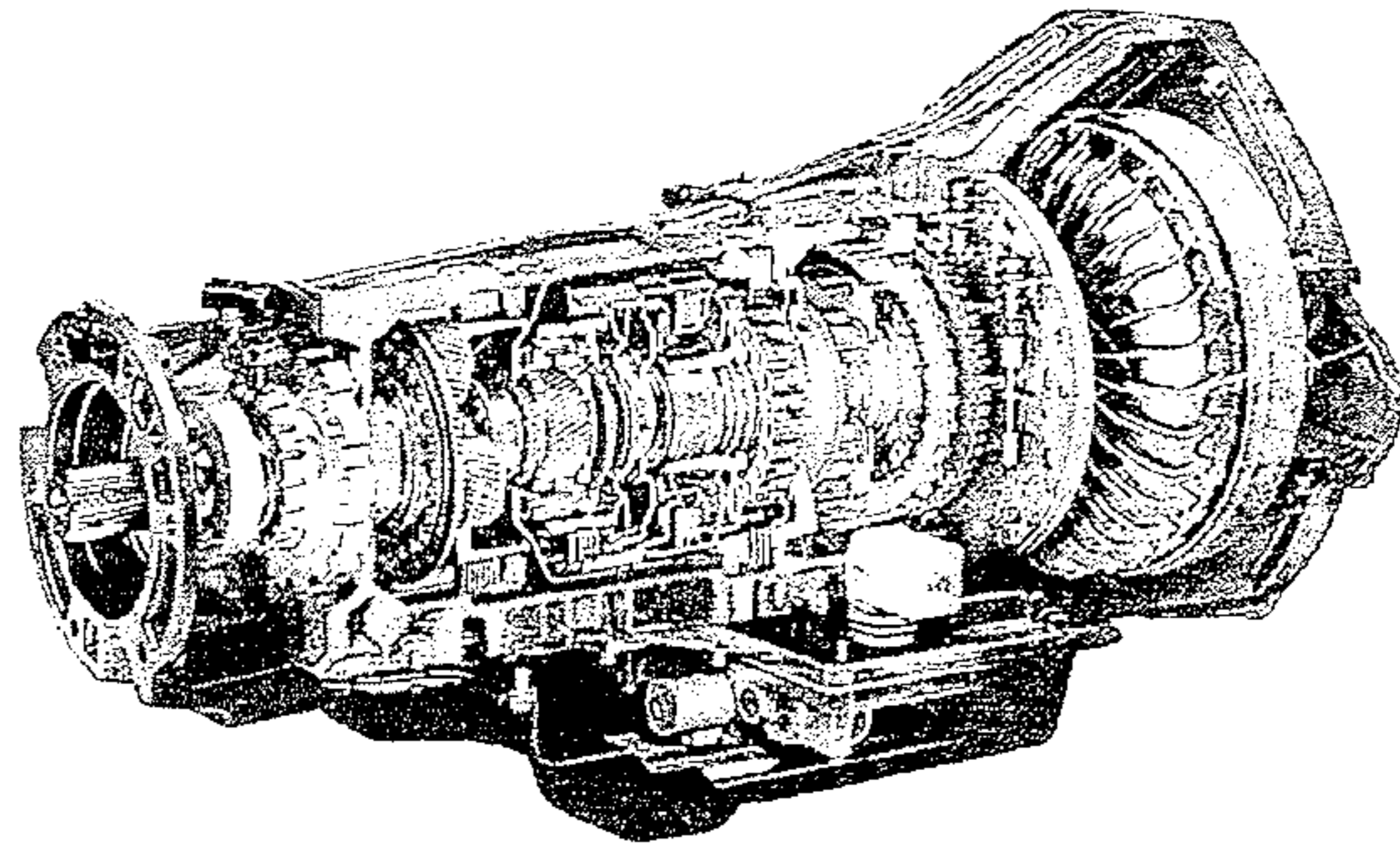

**We proudly welcome all New Customers  
and Former Advanced Transmission  
Customers with a 10% Discount and Any  
Transmission Service or Repair\***

865-986-9359

865-986-5050

## Bad Credit, No Credit OK!!! We Finance Everybody!!!

### Low Down Payment!!!

Over 100 Cars, Trucks & Vans in Stock - Warranties On ALL Vehicles Sold!!!

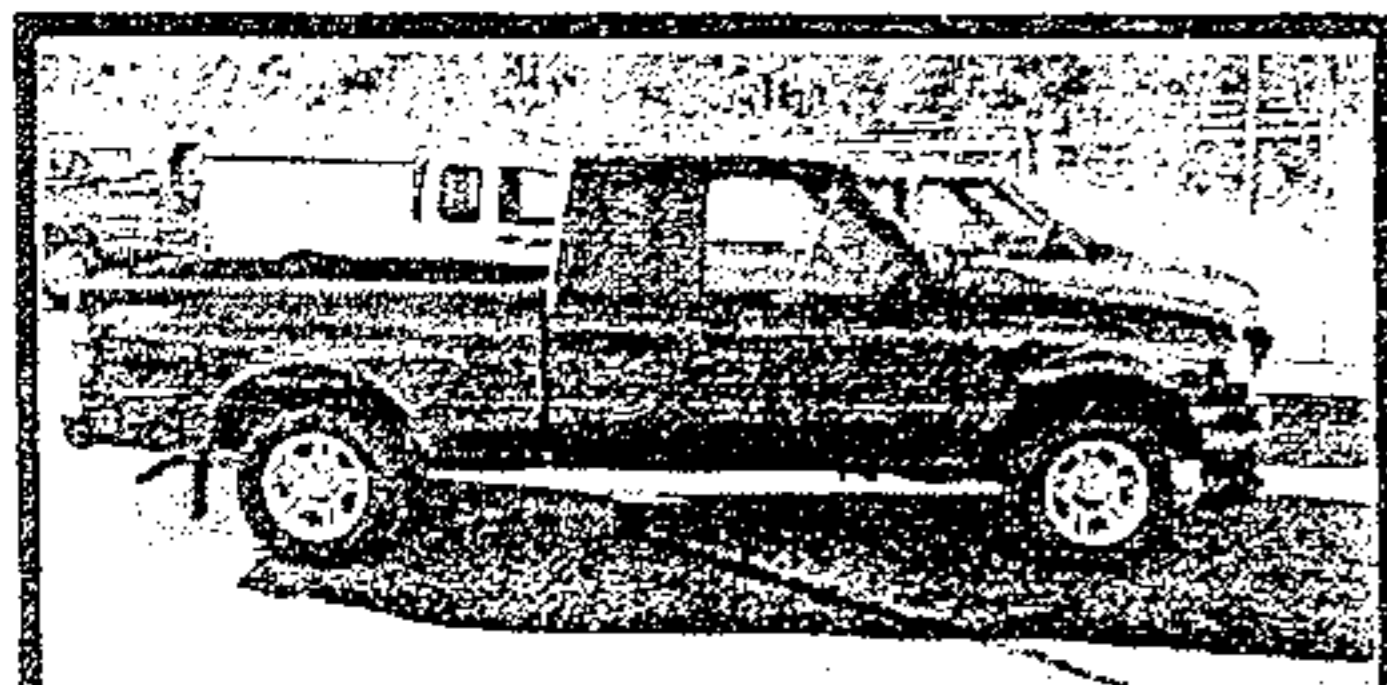

2005 Ford Ranger, Super Nice Truck, Very Low Miles

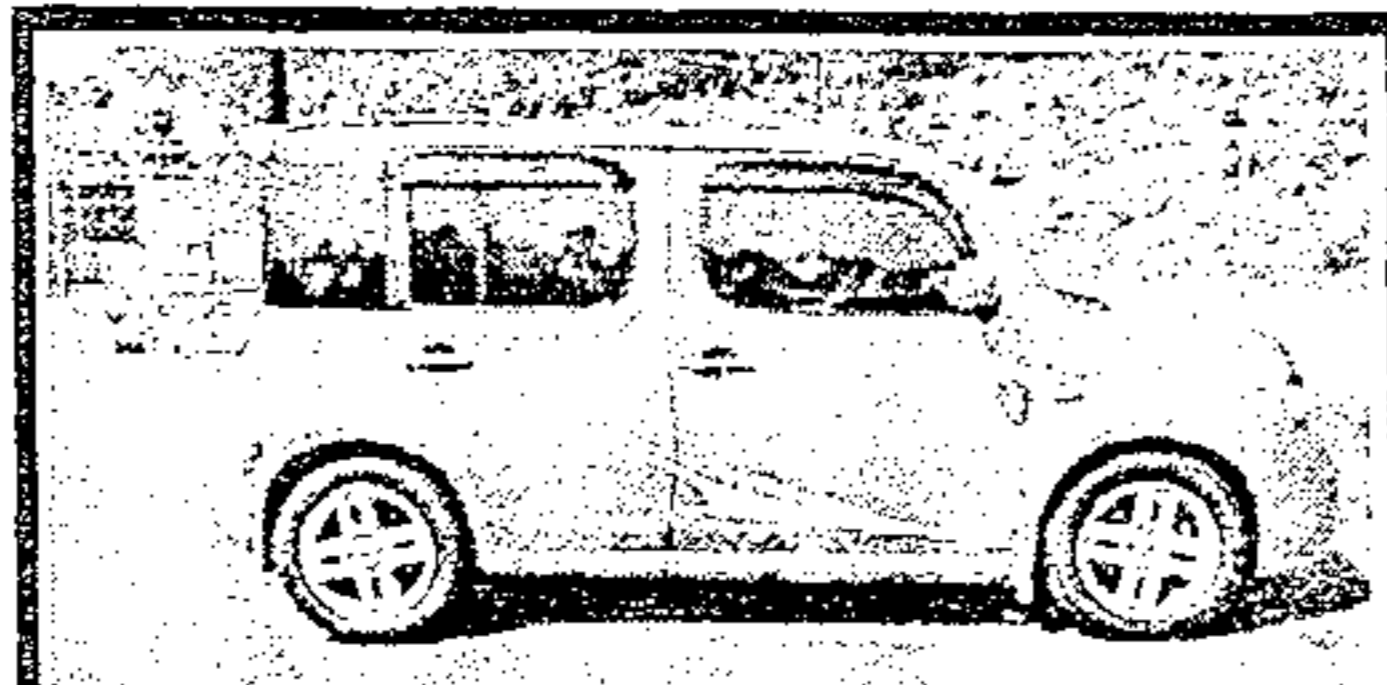

2009 Nissan Cube, Great Gas Saver, Clean

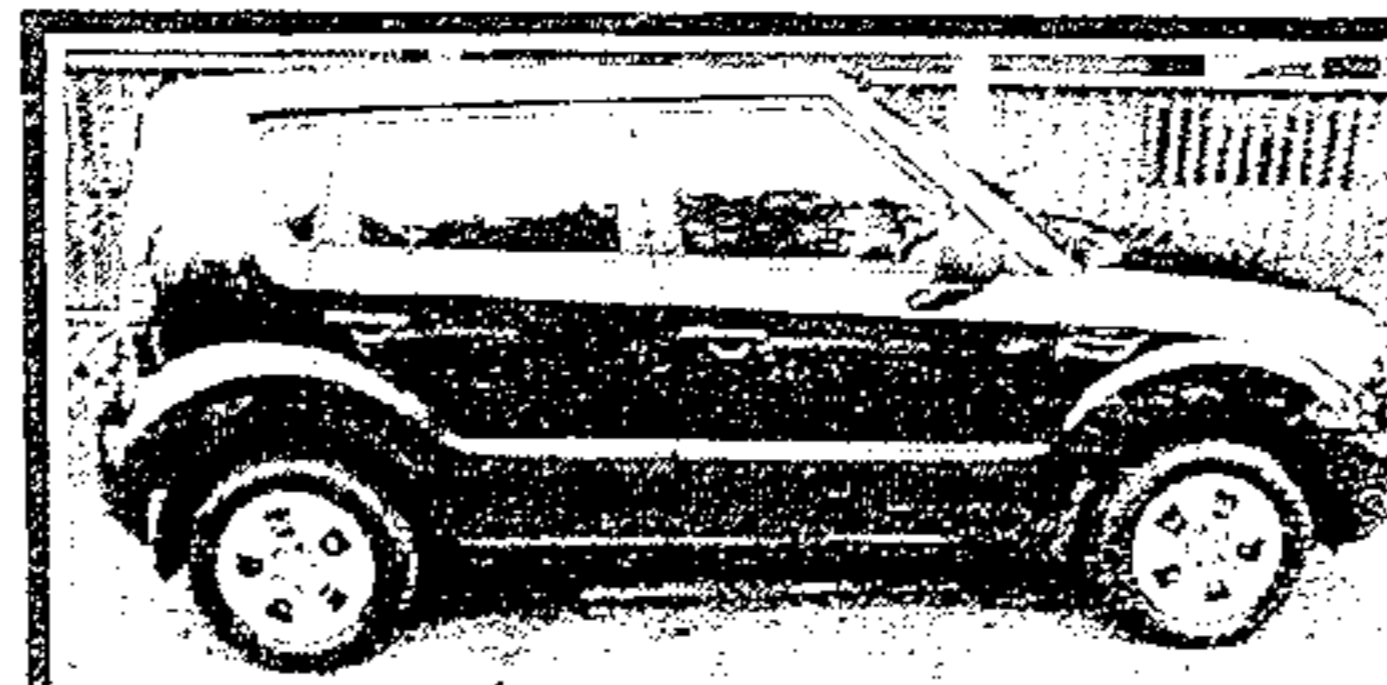

2011 Kia Soul, 5 speed, 4 dr, Gas Saver, Nice & Clean



2007 Chevy Equinox, 4dr, Extra Clean, lots of room

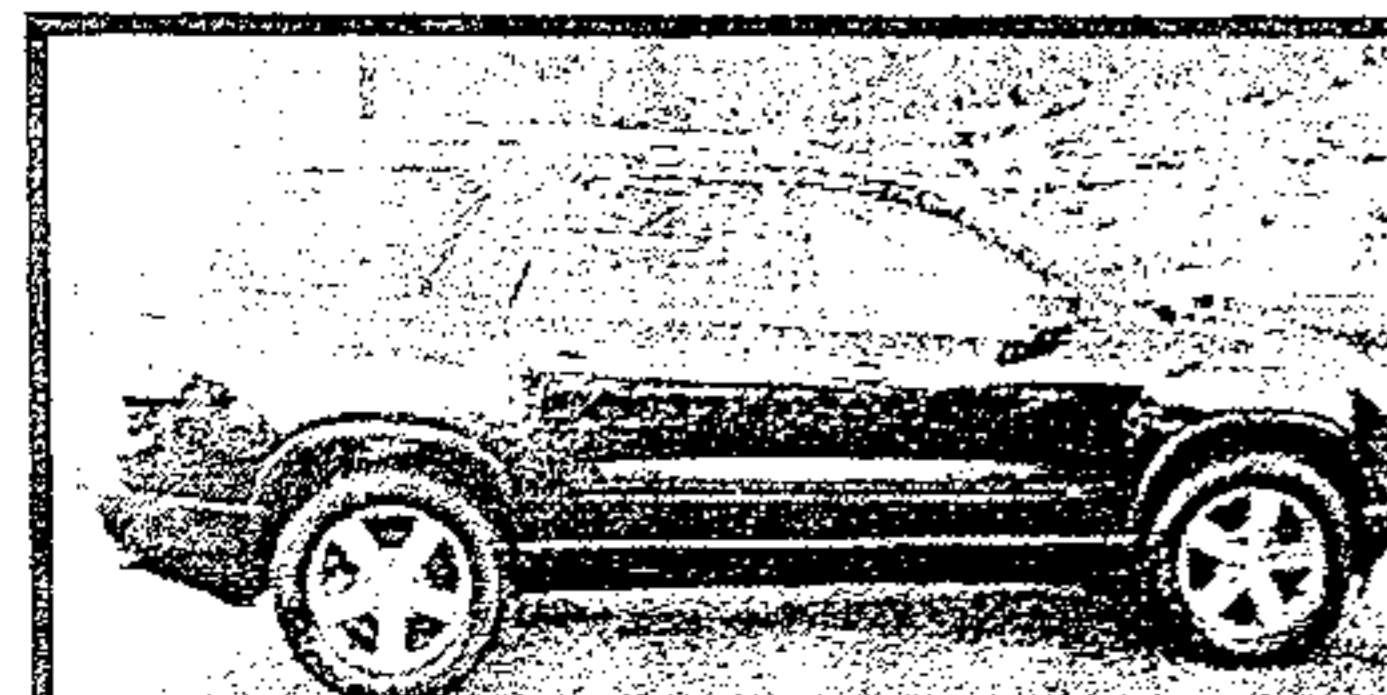

2010 GMC Acadia, Leather, 3rd row, sunroof, Loaded

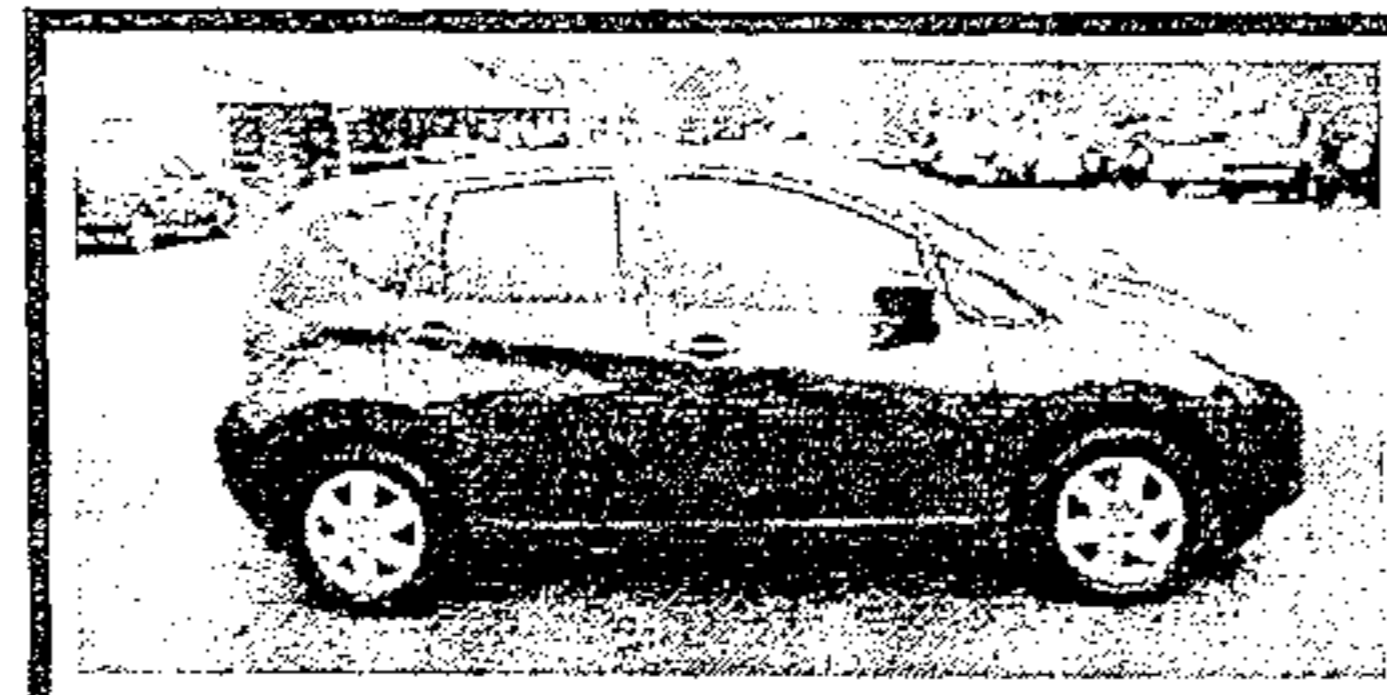

2015 Versa Note, ONLY 19k miles!, Factory Warranty!

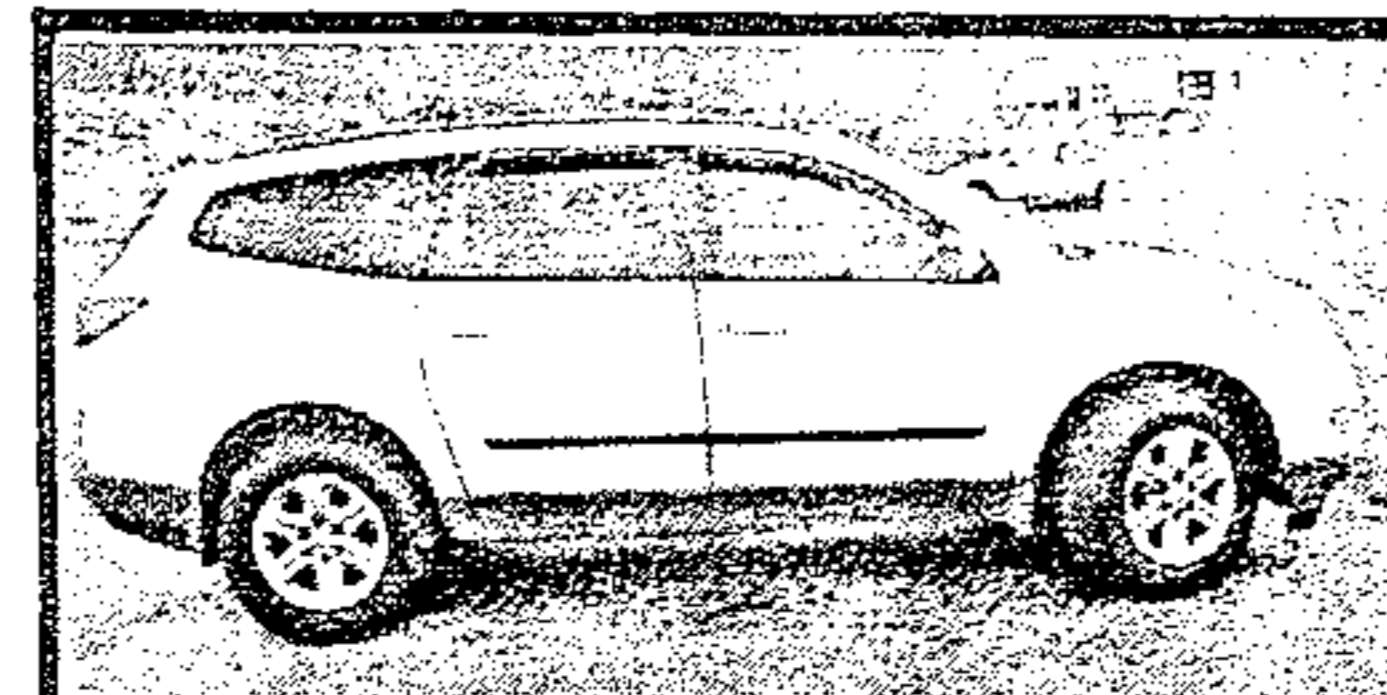

2010 Chevy Traverse, 3rd row seat, Loaded, Clean

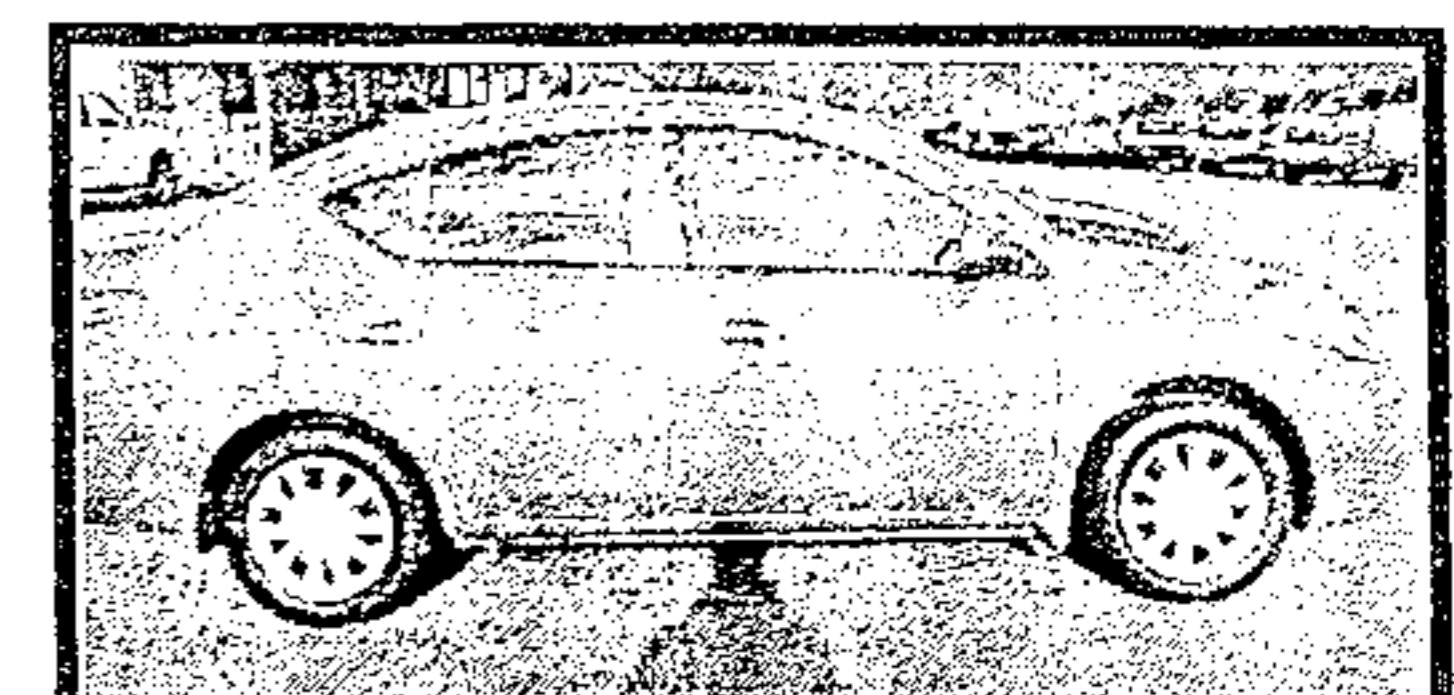

2013 Nissan Versa, Like New! LOADED!!!

## WALT WILLIAMS, INC.

\*with approved credit

3003 Highway 11 Lenoir City, TN **865-986-1111**