

# The Daily Edition

50¢

Serving Loudon, Monroe and Surrounding Counties

Wednesday, December 23, 2015

## Double domestic charge for Loudon man after witnesses point to incident



Christopher Dailey

Christopher Dailey, 33, Vale Street Loudon, was charged with Domestic Assault x2. Officer Garry Kerley LPD, responded to the area of Chamber of Commerce and Angel Row on a domestic occurring. Upon arrival Officer came in contact with 2 witnesses that directed Officer just across the railroad tracks on Commerce Street to a female with a child that were being verbally abused (see DVx2 pg. 7)

## Crack Cocaine dealer sentenced to 12 years in prison

On Dec. 21, 2015, 12 years in federal prison by the Honorable J. Ronnie Greer, U.S. District Judge. (see prison pg. 3)

## Lenoir City man indicted for sexual battery by an authority figure

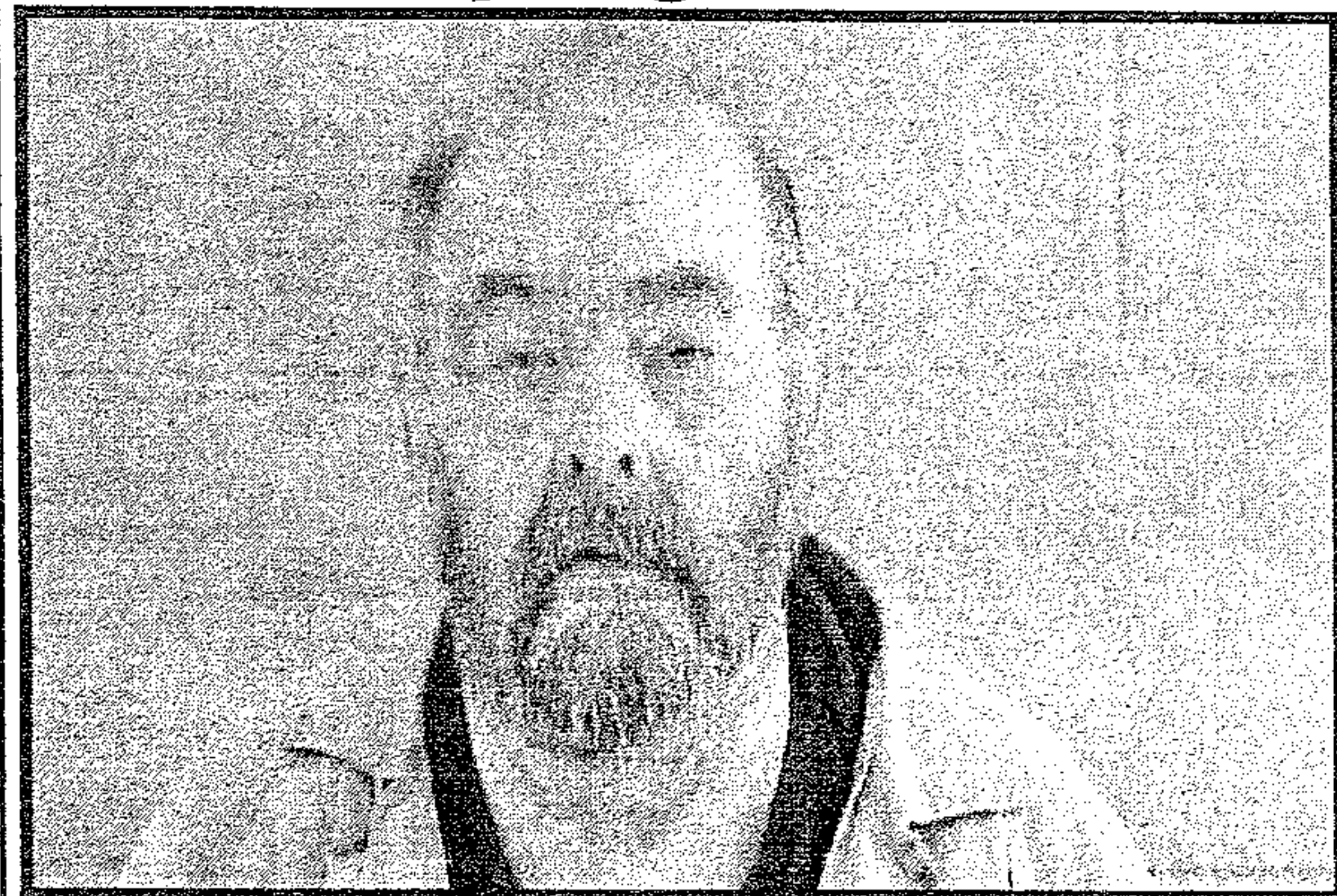

Ernest Hendrickson

(see battery pg. 7)

## District Attorney General acknowledges 2 TBI investigations ongoing as to Morgan County Jail

This information is being provided in response to a request from the Morgan County News who called wanting information about a TBI investigation (based upon an undisclosed tip to that newspaper) into an assault that occurred at the Morgan County Jail in November.

The 9th District Attorney General (9th

DAG) Russell Johnson acknowledges that he has recently predicated two TBI investigations into allegations of assaults on an inmate at the Morgan County Jail.

The first investigation predicated on November 24th involves an allegation of an inmate on inmate assault whereby two corrections officers may have encouraged the assault (see DA pg. 5)

## Violent Carjackers Sentenced

### Law Enforcement Partnerships Have an Impact

From late December 2012 to mid-January 2013, a series of violent carjackings in and around the Atlanta metro area shook the region and caused a significant violent crime spike. But a partnership between the FBI and law enforcement authorities in Cobb, Fulton, Gwinnett, and DeKalb Counties resulted in the dismantlement of the dangerous gang of criminals responsible.

And seven of those criminals were recently sentenced to federal prison terms, including the leaders of the so-called Bandits street gang, Ladarious Gibbs and Derek C. Turner.

The defendants were charged in connection with at least seven carjackings. During these crimes, the victims were typically accosted as they were entering or

(see FBI pg. 2)



## LC man indicted for theft/burglary

Henry Cutshaw, 37, Hwy 321 N Lenoir City, was charged with Criminal Court Capias (Theft of Property/Burglary).

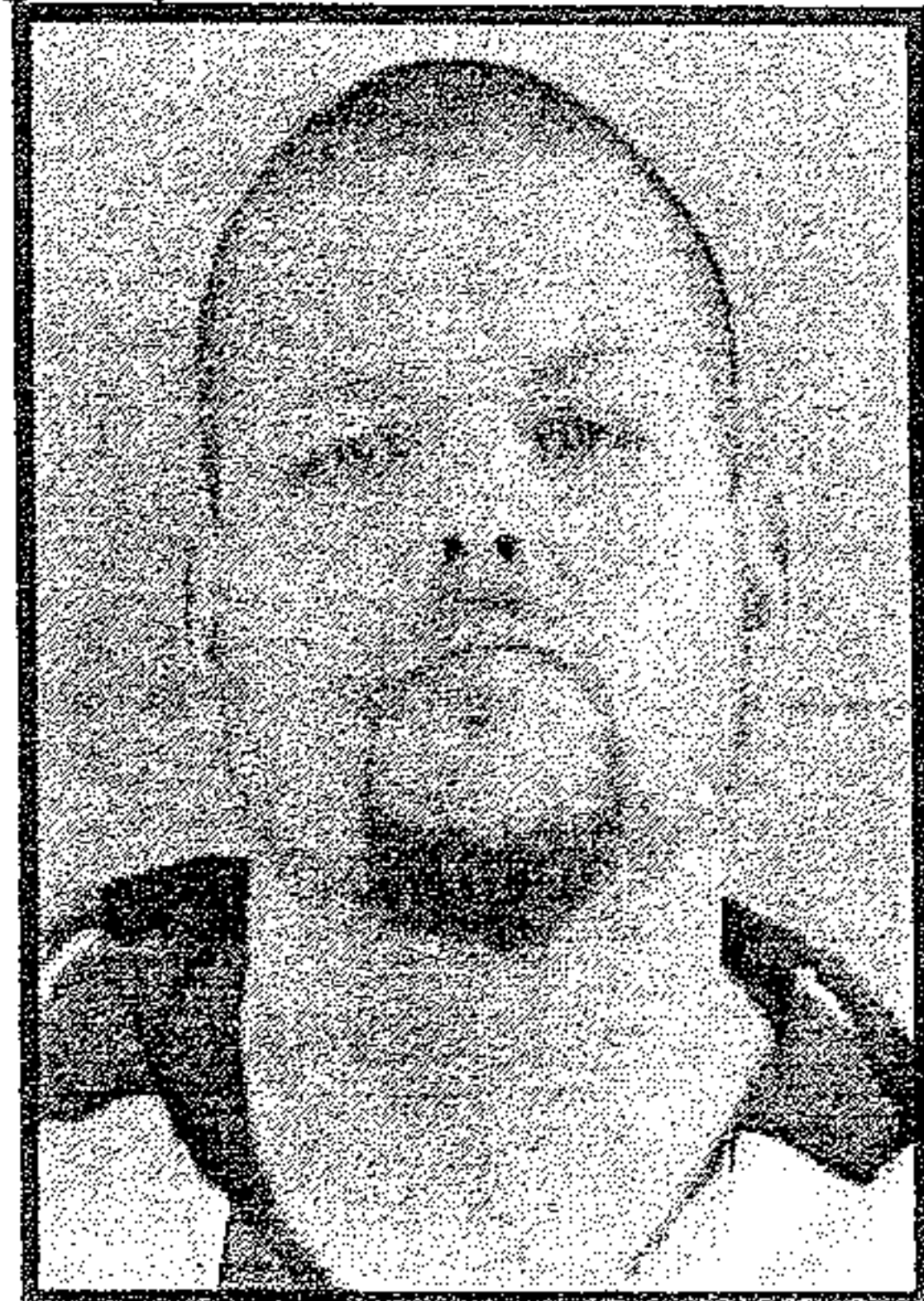

Henry Cutshaw

## Verse of the Day

God sent his Son, born of a woman, born under law, to redeem those under law, that we might receive the full rights of sons. — Galatians 4:4-5

## Obituaries

see inside **Wazzup**  
It's just 2 days til Christmas, just try to remember Jesus is THE Reason for the Season and a Very Merry Christmas to Ev-

everyone from The Daily Edition!

## Weather

Today: Rain showers in the morning with numerous thunderstorms developing in the afternoon. High 69F.  
Tonight: Thunderstorms.

Storms could contain damaging winds. Low 64F.

Thursday Thunderstorms A few storms may be severe. High 71F.

Thursday Night Thunderstorms likely. Low 62F.

(Continued on page 6)

**FBI**

exiting their vehicles. Using a particularly frightening modus operandi, one gang member would approach from the victim's right side while the other would approach from the left, both pointing firearms and demanding the car. The carjackers were brazen—many of the incidents took place in daylight and at locations where the victims—young, middle-aged, and elderly—were going about their

daily lives, such as libraries, shopping malls, gyms, bars, etc. Accounts from the victims were harrowing. For example, a young woman who was eight months pregnant ended up going into pre-term labor and had to be hospitalized. In another case, shortly after one carjacking incident, the criminals raced onto a nearby interstate and crashed the stolen vehicle into a median—but when a couple

(see FBI ctd. pg. 3)

**Call 865-771-2249 to Advertise and start saving today!**  
**Has your group got an event coming up?**  
**Let us know!!!**

**Notice**

Reward offered for the return of a handmade black walnut baby cradle and 700 strands of African trade beads stolen from our home. If you have any information please call 865-250-9280.

Notice: The Daily Edition does not knowingly accept fraudulent or misleading materials. The Daily Edition cannot guarantee the validity of offerings or statements contained herein. All liability for the contents of all advertising, and for any claims that may arise therefrom, is the responsibility of the advertiser or its agency. The Daily Edition reserves the right to reject, edit, or abbreviate any advertisement submitted. Advertising is accepted with the understanding that all liability for all copyright violations is the sole responsibility of the advertiser. Photographs, artwork and other copy submitted for publication is considered the sole property of the advertiser. The Daily Edition will make every effort but will not be liable for failure to publish and ad or for typographical and layout errors. All statements and information about highlights featured items, letters to the editor, herein are those solely given to the interviewer or writer and the Daily Edition assumes no responsibility of the accuracy or validity thereof. The Daily Edition will gladly reprint at no charge that part of an advertisement in which an error occurs provided a claim is made within 3 days of the first publication of the ad. Information contained in the Wazzup is received anonymously and the Daily Edition assumes no responsibility for information and reserves the right to edit or reject any and/or all submissions. The Daily Edition is a daily newspaper of general circulation in Loudon County defined under TCA 2-1-104(a)(13). The Daily Edition also serves Monroe, Knox, Anderson, Roane and Blount counties and serves 30,000 readers weekly. Send mail to PO Box 1240, Lenoir City TN 37771. 865-771-2249. email: dan1204us@yahoo.com  
 The Daily Edition is Loudon County's premier public interest and paid advertising paper. The Daily Edition is produced and published daily Monday through Friday and is circulated throughout Loudon County and parts of Monroe and Knox Counties. Display advertising rates \$5.00 per column inch and quantity discounts available. Call for information on upcoming promotions and events.

**HACIENDA Ayala's**  
**Mexican Restaurant**  
 Market Dr. \* Lenoir City (In Front of Food City)

**Real Authentic Mexican Food at Affordable Prices**

**BEST MARGARITA**

You've Tried The Rest  
 Now Come Have The Best!!!

We Accept ALL Competitors Coupons Outside of Mexico City!

986-3553



**Good Credit OK • Bad Credit OK • Bankruptcies OK • Repo OK**



2010 Kia Soul Sporty, 4 cyl, Auto, PW, PL, A/C, Great On Gas, Like New



2010 Ford Escape Limited Leather, Alloy Wheels, Heat, A/C, Luggage Rack, 79K,



2007 Dodge Ram 1500 Quad Cab, Thunder Road PKG, 20 in. Wheels, Low Miles, Herri



2008 Ford Explorer 84k, 3rd Row Seating, Luggage Rack, Tow Pkg, PW, PL



2011 Ford Ranger Low Miles, Tow Pkg, New Tires, A/C, Heat, Bed Liner.



2011 Dodge Grand Caravan DVD, Stow & Go, Loaded, Remote Doors, Rear A/C

**DEPENDABLE MOTORS 986-9343**  
**803 E. Broadway • Lenoir City**

\* WAC. See Dealer for details

Visit our website at: [www.dependablemotorslc.com](http://www.dependablemotorslc.com)

**Serving Loudon County for 20 Years**

prison

Upon his release from prison, Manuel will serve a 6 year period of supervised release. Manuel pleaded guilty to a federal grand jury indictment charging him with possession of more than 28 grams

of cocaine base (crack) with the intent to distribute. Law enforcement made a series of controlled buys of crack cocaine from Manuel and then obtained a search warrant for his residence. During the execution of the search warrant on May 5, 2014, law enforcement employed a plumber who recovered baggies containing approximately 54 grams of crack cocaine from Manuel's septic tank system. The investigation determined that the crack cocaine had been flushed down a toilet as the officers entered the residence. Manuel has two prior felony convictions for sale and delivery of cocaine and crack cocaine.

The investigation into the drug trafficking of Manuel was conducted by the 3rd Judicial Drug Task Force and

was supported by the collaborative effort of several law enforcement agencies including the Greene County Sheriff's Office, Greeneville Police Department, and the Tennessee Bureau of Investigation.

The 3rd Judicial District Attorney's Office also provided assistance in the case. Assistant U.S. Attorney J. Christian Lampe represented the United States.

FBI ctd. from pg. 2

of good Samaritans stopped to help, they themselves were car-jacked. And during another car-jacking that took place in front of a department store, a passerby—who happened to be a store employee—was shot in the leg and suffered serious, long-term medical issues.

Eventually, local law enforcement agencies were able to link several of the vehicles that the

(see FBI ctd. pg. 5)

**For Sale: oak Wood Mulch**

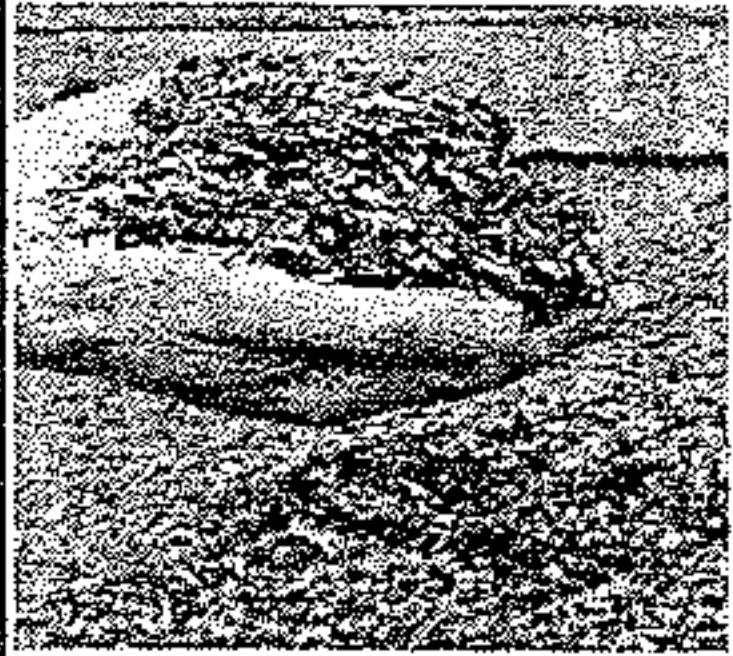

Mushroom Compost Topsoil.

**Firewood**



Call Steve Spoon 986-4282

**West End Storage & Warehouses**  
**502 Ward Avenue • Loudon**  
**Call 865-458-4774 or 865-679-5555**

**C&J Towing and Recovery**  
**LOWEST TOWING RATES AROUND!!!**

Have you been overcharged for any type of towing service in the Lenoir City area? If you have a breakdown or accident please OWNER REQUEST C&J Towing with the officer. Also please call your Sheriff and ask him to place C&J Towing on the "Rotation List\*" and help other motorists save as much as you did! We at C&J are locally owned and operated, State approved, licensed, bonded and insured. Call and let us know if your denied service or how we can be of assistance.

\*note: the "Rotation List" is a list of wrecker services that provide service for wrecks, DUI's, breakdowns, etc. and are on an on-call basis for service. This list is approved by the Sheriff.

Cliff Teeters • Owner  
**865-809-1661**

**STAINED INK**  
**TATTOO & PIERCING**  
**LENOIR CITY 865 816-6440**  
**NEW OWNER • NEW ARTIST • SINCE 2011**  
**521 Hwy 321 next to Vape & Stuff & Inn Of Lenoir!**  
**Clean-Affordable-Quality-Custom**  
**Tattoo's You've Always Wanted!**

BRING IN THIS AD FOR **\$25 OFF!**  
**NEW INK FOR NEW CUSTOMERS ONLY!**

Check us out on FB.com/  
**Stained.Inc.Tattoo/**  
**www.STAINEDINK.com**

**BIMBO'S**  
**Deli Open 24 Hours**  
**865-986-9643 Call Ins Welcome**  
**Specials**  
**Lg. Cold Sub, bag of chips and 16 oz. fountain drink**  
**only \$6.29**  
**Footlong Corn Dog \$2.59**

DA

and at least stood by while it occurred.

The second investigation predicated on December 15th involves an allegation of four corrections officers assaulting an inmate hours after that same inmate made a seemingly unprovoked but violent assault against two corrections officers.

All TBI investi-

gations are deemed confidential and not subject to public review according to state statute TCA 10-7-504(a)(2)(A). No further information will be released by the 9th DAG until both investigations are concluded and, in the event that there are any charges criminal charges, information from the TBI investigative file will not be released until the case(s) are

concluded.

The policy of the 9th DAG office is to present the results of all TBI investigations that indicate a finding of possible criminal conduct to the appropriate county grand jury for that grand jury's review, once the investigation is concluded. If the 9th DAG deems the conduct to be criminal conduct capable of successful prosecution, then an indict-

ment is presented to the grand jury as they make their review.

The next meeting of the Morgan County Grand Jury is on Monday, January 25, 2016. If any investigation is not sufficiently concluded, TBI or otherwise, then it is not be presented to a grand jury.

Also, keep in mind that any subject of a TBI investigation or other investigation is

deemed by the criminal justice system to be innocent of any allegation until proven guilty jury or convicted by a court.

**FBI ctd. from pg. 3**

suspects traveled in as well as bullet shell casings found at the crime scenes. Some of the suspects also bragged about their exploits in a video posted on a social media website. And one individual took picture of himself with a victim's cell phone—unbeknownst to him, the photos were saved to the victim's cloud computing account.

In February 2013, six individuals were charged at the state level—of those, five were taken into custody by the Atlanta Police Department. But because of the multi-jurisdictional nature of the crimes, the fact that some of the suspects were repeat offenders, and because the federal carjacking statutes provided for harsher penalties, local authorities began looking into the possibility of federal charges and asked for the assistance of the Atlanta FBI Office.

Bureau investigators—working hand in hand with the U.S. Attorney's Office for the Northern District of Georgia, the Cobb County and Atlanta Police Departments, and local prosecutors—conducted additional interviews, sent DNA evidence and latent fingerprint evidence to the FBI Laboratory, and analyzed suspects' phones. An additional suspect was identified, and there was enough evidence gathered against Bandit gang members to convince a federal grand jury to begin handing down indictments in July 2013. A final superseding indictment was filed

(see FBI conc.. pg. 8)

# PURDY'S AUTO PARTS AND SALVAGE

**WE BUY SCRAP IRON • COPPER • BRASS • ALUMINUM**

**\$** **Paying Top \$\$\$**  
Call For Latest Prices

*You Name It, We Buy It!*

*Radiators, Wheels, Batteries, Appliances, Farm Equipment*

**Complete Cars**  
per 100 lbs.

**Scrap Metal**  
**Paying Top \$\$\$**  
Call For Latest Prices  
per 100 lb

**Copper**  
**Paying Top \$\$\$**  
Call For Latest Prices

**We Buy Batteries**

**Aluminum Cans**  
**Paying Top \$\$\$**  
Call For Latest Prices

**You Call We Haul!**  
**423-519-5402**

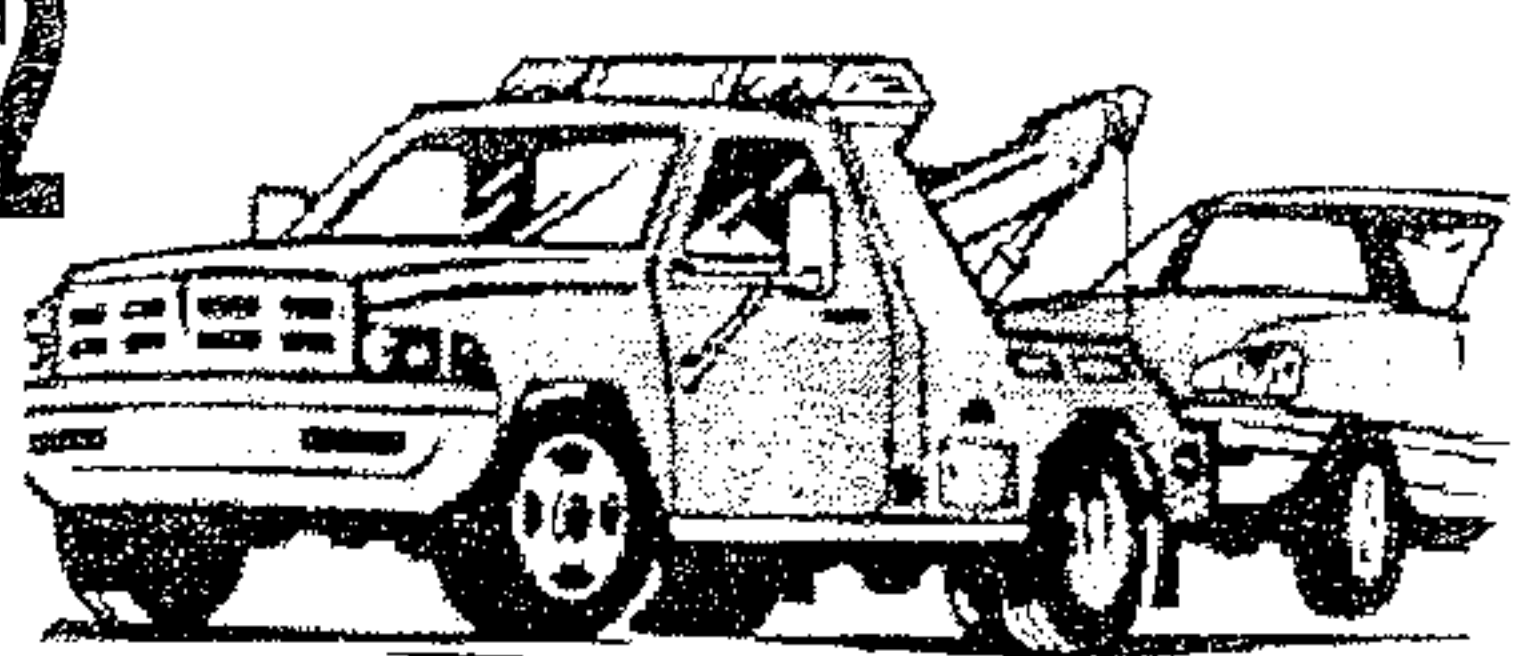

**Now Selling**  
**Aftermarket**  
**Body Parts at**  
**Discount Prices**

\* Prices subject to change with the market.

**423 337-3977**  
**149 County Road 323 Sweetwater**

\* Prices subject to change with the market.

**DVx2**

by a male subject as they were attempting to walk down Commerce St. The male was detained and identified as Christopher Dailey. After speaking with victim and witnesses it was learned that Charles was the primary aggressor and placed under arrest. Officer Garry Kerley LPD, made the arrest.

**battery**

Ernest Henderson, 68, Peachtree Street Lenoir City, was charged with a Capias (Sexual Battery by an Authority Figure. Deputy Charlie Huskins LCSO, arrested Ernest at the Peachtree Street address and transport-

ed to the Loudon Jail.

**Obituaries**

**Rev. George Beach Seay** - age 68 of Lenoir City passed away Tuesday, December 22, 2015 at his home. George entered into the ministry in March of 1966. He was currently the pastor at Bell Avenue Baptist Church. He had also pastored at Lakeview Baptist Church and Smith Grove Baptist Church in Knoxville. George retired from the Lenoir City Utility Board. He was preceded in death by his wife of 48 years, Glenda Seay; parents, Sola and Gladys Beach; sisters, Betty Beach, Sue Beach Howell, and Dwana Barron; brothers, S. J. Beach, Bobby Beach, Buddy

Beach, Charles Beach, and Dick Beach; parents by adoption, Rev. Joe Seay and Flora Seay. Survived by his daughter and light of his life, Lisa Gail Seay; sisters, Helen Beach Thomas of Charlotte, NC and Sandra Beach Thomas of Mt. Vernon, OH; brother, Dr. Ted Beach of Johnson City, TN; sisters-in-law and brothers-in-law, Linda and Clifton Posey; Brenda (Jackie) and Henry Yarnell, and Howard H. Pratt, Jr.; best friend, Carroll T. Watts of Knoxville, TN; several nieces and nephews. The family will receive friends from 2 p.m. to 4 p.m. Saturday, December 26th at the Bell Avenue Baptist Church in Lenoir City. Funeral services will follow at 4 p.m. with Rev. Junior

Gardner and Rev. Gordon Dykes officiating. Family and friends will gather at the funeral home by 1:30 p.m. on Sunday and proceed to the Lakeview Cemetery for graveside services at 2 p.m. with Rev. Charles Hunt officiating. Honorary pallbearers will be the Deacons of Bell Avenue Baptist Church and area ministers. Click Funeral Home, 109 Walnut Street, Lenoir City is in charge of arrangements.

**Dolly Spears Meyers** - age 28 of Lenoir City passed away Sunday, December 20, 2015. Dolly was a loving mother, daughter, sister and friend. She was preceded in death by her mother, Peggy Spears; grandparents, William Glenn Hinton, Dolly Marie Spears,

Jack Charles Young and Dorothy Marie Young. Survived by her son, Anthony Meyers; father, Franklin Spears; sisters, Peggy Mendez (Mayron), Lisa McCulloch (Dustin), and Tina Edgin; brothers, Bobby Spears (Brandy) and Nick Durga; many nieces, nephews and friends. The family will receive friend from 5 to 7 p.m. Wednesday, December 23rd at Click Funeral Home in Lenoir City. Funeral services will follow at 7 p.m. with Rev. Scott Capooth officiating. Family and friends will gather at 11 a.m. Thursday at the Cloyds Creek Cemetery in Blount Co. for graveside services.

Click Funeral Home, 109 Walnut Street, Lenoir City is in charge of arrangements.

LOOK!
\$75 Weekly Payments
LOOK!

MARTY'S AUTO SALES • 986-2222
MARTY'S AUTO SALES • 986-2222
MARTY'S AUTO SALES • 986-2222
MARTY'S AUTO SALES • 986-2222
MARTY'S AUTO SALES • 986-2222

Bad Credit

Divorce

Fixed Income

Repos

Bankruptcy

No Credit

# APPROVED!

Visit Us On The Web At:

## martyautosales.net

NO

CREDIT

CHECKS

\$499 down\*

07 Cobalt, 5spd, gas saver, runs great Only \$499 down\*

\$499 down\*

02 Sable, sunroof, loaded, Only \$499 down\*

\$499 down\*

04 Cavalier, 2dr, Sporty, Only \$499 down\*

\$499 down\*

01 Sebring 2dr. sporty, Only \$499 down\*

\$299 down\*

00 Civic, auto, Gas Saver, Only \$299 down\*

\$399 down\*

06 PT Cruiser, auto, gas saver Only \$399 down\*

\$399 down\*

04 Stratus, 4 cyl, Runs good, Only \$399 down\*

\$99 down\*

98 Bonneville, 6 cyl, Auto, low payments only \$99 down\*

NO Credit Checks

# Marty's

## Auto Sales

986-2222

\*See Dealer for details. All down payments plus tax, tag, title and fees.

Se Habla Espanol

100% Approval\*

MARTY'S AUTO SALES • 986-2222
MARTY'S AUTO SALES • 986-2222
MARTY'S AUTO SALES • 986-2222
MARTY'S AUTO SALES • 986-2222
MARTY'S AUTO SALES • 986-2222

FBI ctd.. from pg. 2

in May 2014.

After the sentencing of Gibbs, Turner, and three other co-conspirators, FBI Atlanta Special Agent in Charge J. Britt Johnson said that cases like this one require "the combined efforts and resources of law enforcement working together

and across jurisdictional boundaries to get these violent offenders off our streets and into prison."

This same sentiment is echoed in communities around the country wherever FBI investigators and state and local law enforcement personnel join together to target violent criminals who threaten public safety.

## THE RELIC SHOP

521 Hwy 321 Lenoir City Suite 3  
next to Stained Inc and the Inn of Lenoir

**OFFICIALLY OPENING THIS SATURDAY  
DECEMBER 26, 2015**

WHERE A PERSON CAN BUY A PIECE OF HISTORY  
INDIAN ARTIFACTS, CIVIL WAR RELICS, FOSSILS  
ANTIQUA GUNS, ANTIQUA POCKETWATCHES,  
OLD COINS AND WHOLE LOT MORE!!!

### Is Your Washer Broken?

Call Me

I Only Charge \$100 Period!!!

Call Allen

865-617-7113

## A Name You Already Know And Trust Just Got Even More Dependable DEPENDABLE AUTO SERVICE, LUBE AND TIRES is Now Offering Expert, Affordable Transmission Service

All ASE Certified Technicians

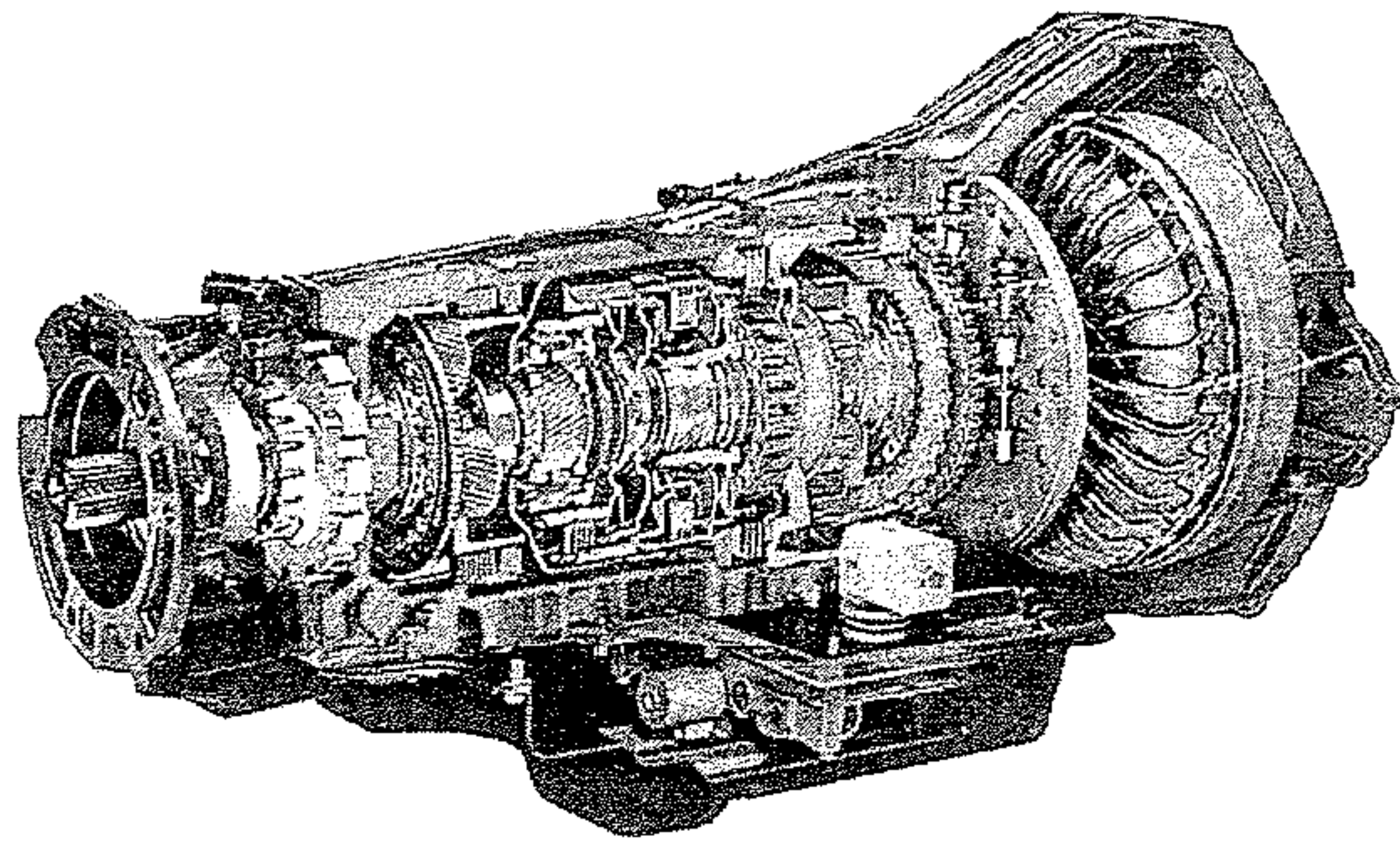

**We proudly welcome all New Customers  
and Former Advanced Transmission  
Customers with a 10% Discount and Any  
Transmission Service or Repair\***

865-986-9359

865-986-5050

## Bad Credit, No Credit OK!!! We Finance Everybody!!!

### Low Down Payment!!!

Over 100 Cars, Trucks & Vans in Stock - Warranties On ALL Vehicles Sold!!!



2005 Ford Ranger, Super  
Nice Truck, Very Low Miles

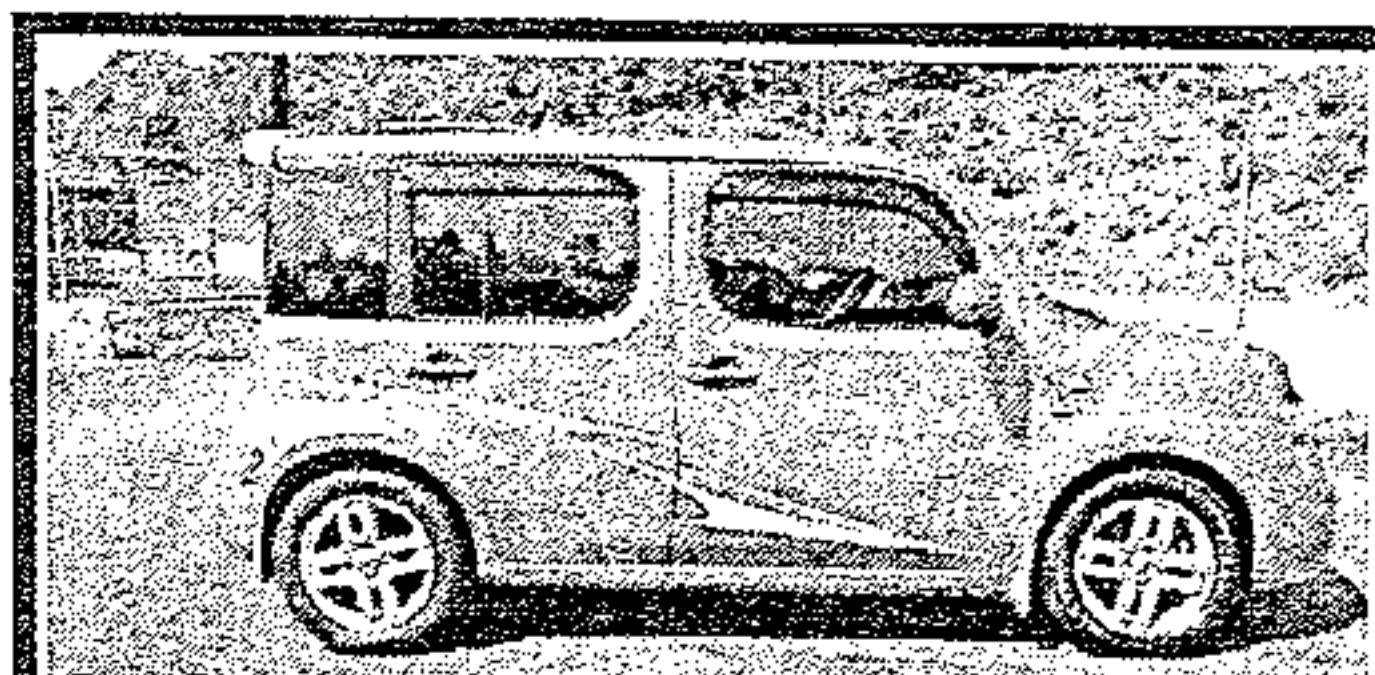

2009 Nissan Cube, Great  
Gas Saver, Clean

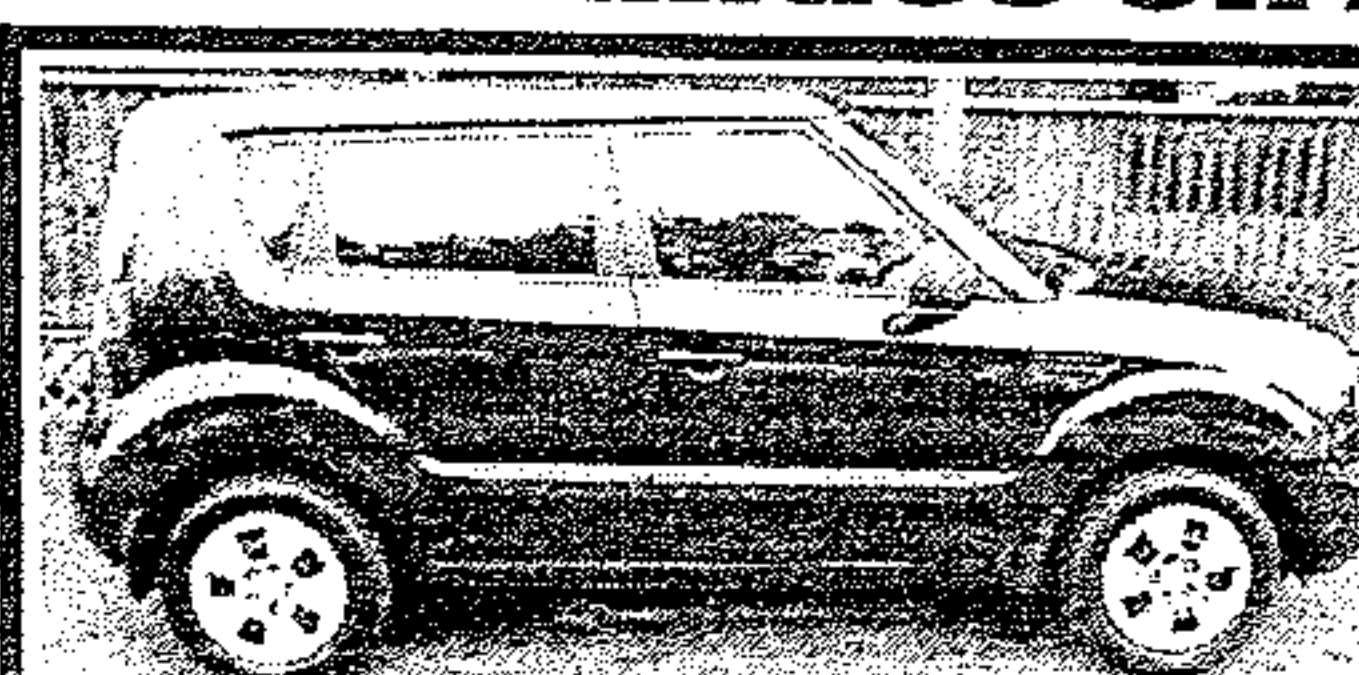

2011 Kia Soul, 5 speed, 4 dr,  
Gas Saver, Nice & Clean



2007 Chevy Equinox, 4dr, Extra  
Clean, lots of room



2010 GMC Acadia, Leather,  
3rd row, sunroof, Loaded

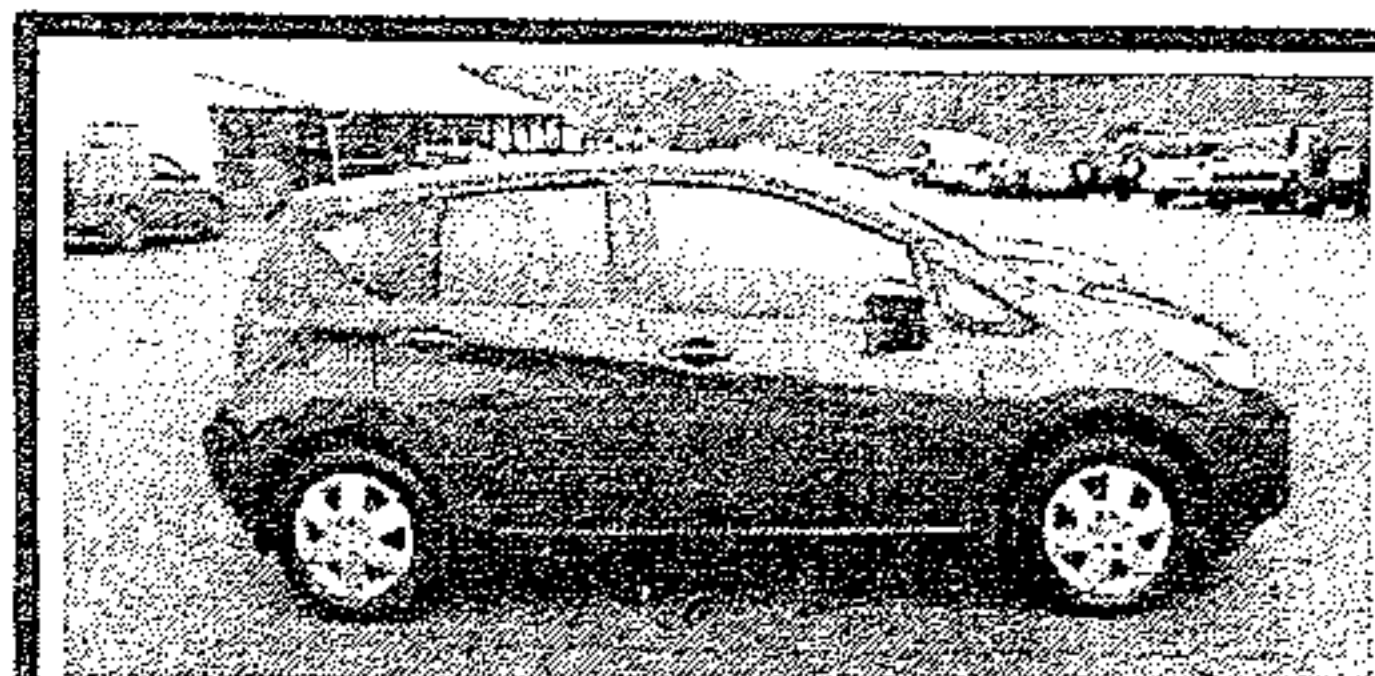

2015 Versa Note, ONLY 19k  
miles!, Factory Warranty!

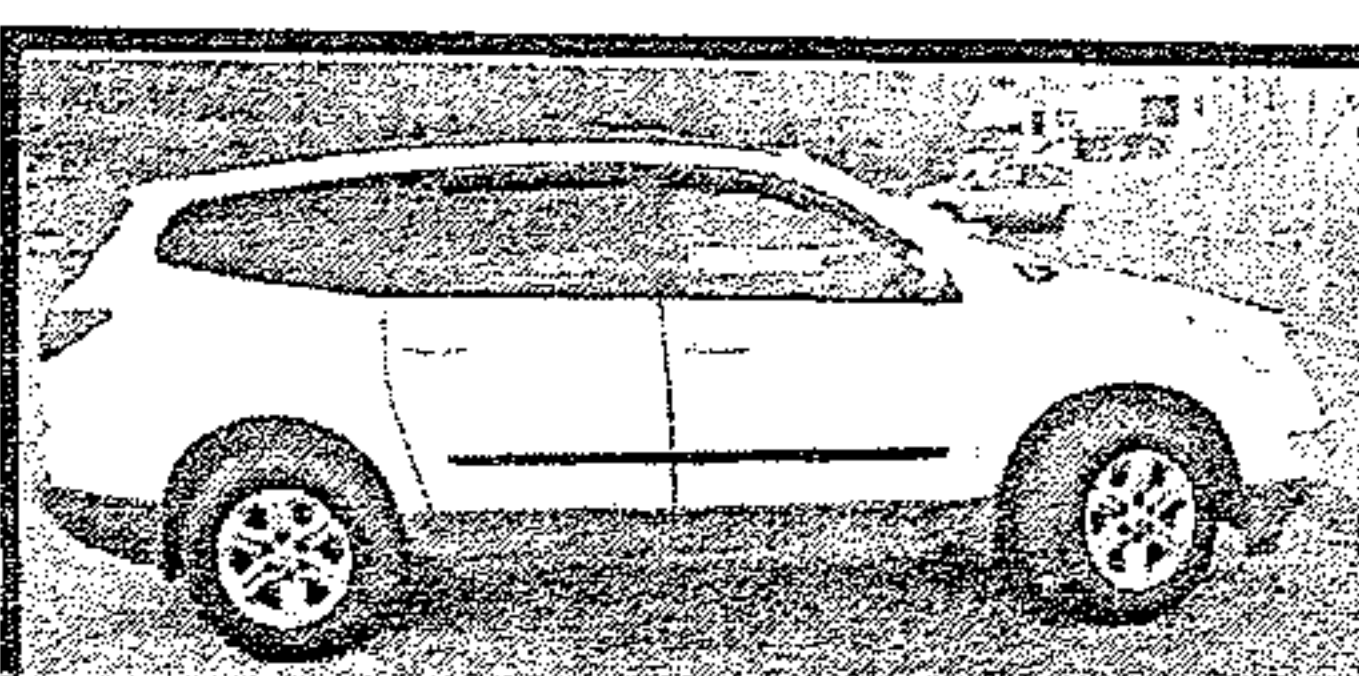

2010 Chevy Traverse, 3rd row  
seat, Loaded, Clean



2013 Nissan Versa, Like New!  
LOADED!!!

## WALT WILLIAMS, INC.

\*with approved credit

3003 Highway 11

Lenoir City, TN

865-986-1111