

The Daily Edition

50¢

Serving Loudon, Monroe and Surrounding Counties

Thursday, December 17, 2015

Fatal Accident in LC Broadway building struck



LCFD firefighters clean up the scene of the fatality on East Broadway Tuesday night

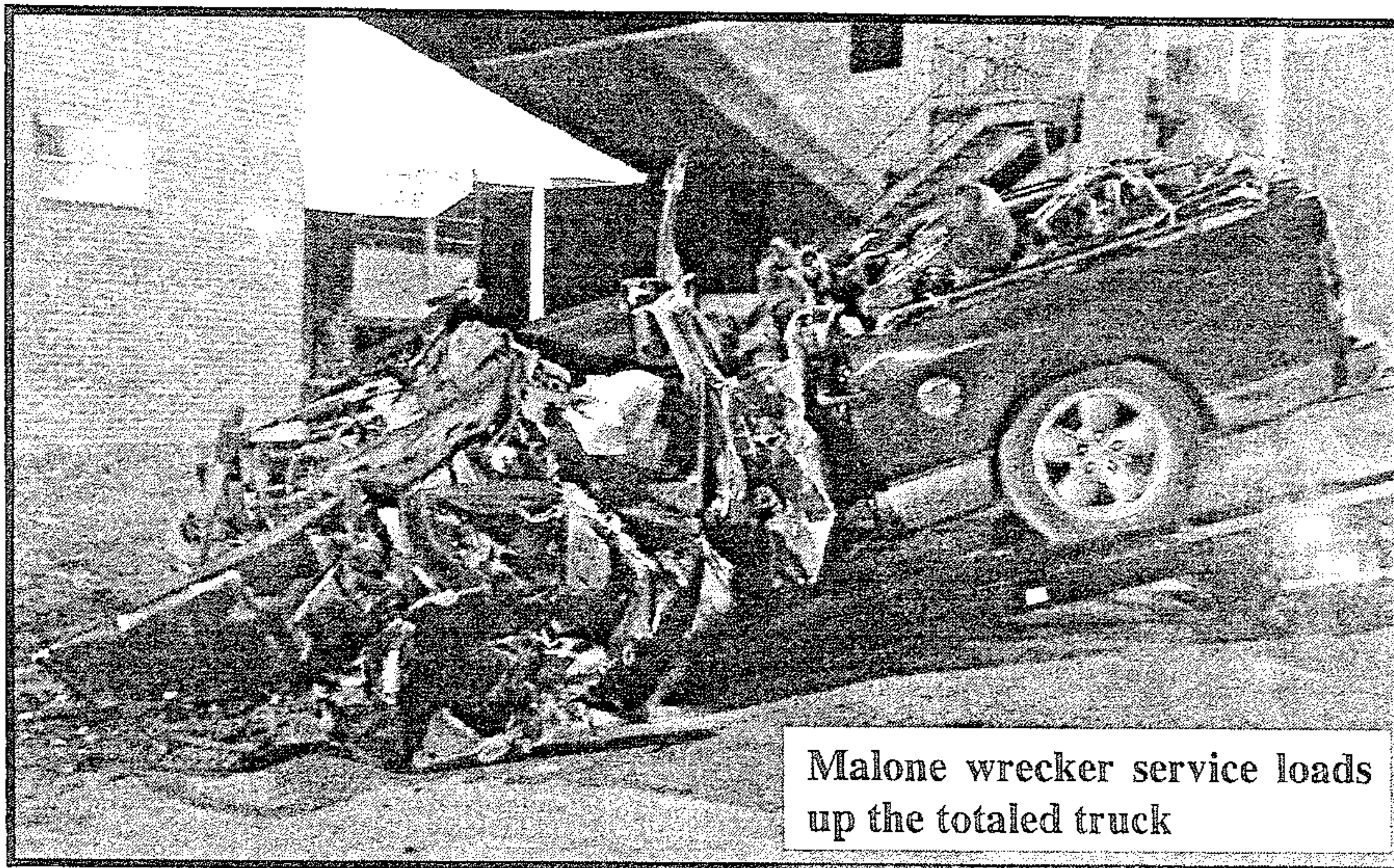

Malone wrecker service loads up the totaled truck

(see Wreck pg. 7)

Everybody gets charged following traffic stop



Kristina Chastain



Lauren Howard

(see LCPD pg. 5)

Human Trafficking Prison Time for Men Who Attempted to Buy Sex Slaves

During the course of an international human trafficking investigation, FBI agents uncovered disturbing information: American men were making what appeared to be serious inquiries about buying kidnapped women from Asia to serve as sex and domestic slaves.

"This case opened people's eyes to a much darker side of human trafficking than we were previously aware of," said Special Agent Ryan Blay, who worked the

investigation from the FBI's Phoenix Division.

The case started in 2012, when agents were alerted to an advertisement from Malaysia on the now-defunct bondage website collarme.com, purporting to sell kidnapped Asian women "who are naturally very obedient."

The online solicitation turned out to be a money-making scam, Blay said, but the response from potential customers in the U.S.—nearly 200 in-

(see slaves pg. 2)

Verse of the Day

Because he himself suffered when he was tempted, he is able to help those who are being tempted.

— Hebrews 2:18

Obituaries

see inside

Wazzup

A Big Shout Out To LCPD and LCFD for your quick response to the wreck on Broadway! It's great to know when you need 'em Bi Golly there they are!

Weather

Today: Rain early. A mix of sun and clouds in the afternoon. High around 55F.
Tonight: Partly cloudy. Low 33F.
Friday: Partly cloudy skies. Cooler. High 46F.

Friday Night Clear skies Low 28F.

Horoscopes

Sagittarius 11/22-12/21
You might not be your regular cheery self today making others wonder if they did something to

(Continued on page 6)



3 08805 93489 2

slaves

quiries during a two-month period—was “alarming.” After the fraudulent advertisement was removed from the website and the FBI referred the matter to Malaysian authorities, Blay and his team devised an undercover operation targeting the same clientele.

“The idea was to be proactive, to identify these individuals and stop them before they could

actually victimize anyone,” he said. The FBI created an undercover platform advertising kidnapped women for sale as sexual and domestic slaves.

“Almost immediately there were responses,” Blay said. “We weren’t interested in individuals who were just pursuing some sort of fantasy,” he explained. “The only people we wanted were those who were serious about buying kidnapped women.”

The undercover operative pos-

ing as the seller “actually tried to talk people out of it,” Blay said. “He stressed that these women would be taken against their will and the transaction would be illegal in every possible way.”

More than 100 people responded, and most dropped out slaves ctd. pg. 7

Notice

Reward offered for the return of a handmade black walnut baby cradle and 700 strands of African trade beads stolen from our home. If you have any information please call 865-250-9280.

Notice: The Daily Edition does not knowingly accept fraudulent or misleading materials. The Daily Edition cannot guarantee the validity of offerings or statements contained herein. All liability for the contents of all advertising, and for any claims that may arise therefrom, is the responsibility of the advertiser or its agency. The Daily Edition reserves the right to reject, edit, or abbreviate any advertisement submitted. Advertising is accepted with the understanding that all liability for all copyright violations is the sole responsibility of the advertiser.

Photographs, artwork and other copy submitted for publication is considered the sole property of the advertiser. The Daily Edition will make every effort but will not be liable for failure to publish and ad or for typographical and layout errors. All statements and information about highlights featured items, letters to the editor, herein are those solely given to the interviewer or writer and the Daily Edition assumes no responsibility of the accuracy or validity thereof. The Daily Edition will gladly reprint at no charge that part of an advertisement in which an error occurs provided a claim is made within 3 days of the first publication of the ad. Information contained in the Wazzup is received anonymously and the Daily Edition assumes no responsibility for information and reserves the right to edit or reject any and/or all submissions. The Daily Edition is a daily newspaper of general circulation in Loudon County defined under TCA 2-1-104(a)(13).

The Daily Edition also serves Monroe, Knox, Anderson, Roane and Blount counties and serves 30,000 readers weekly. Send mail to PO Box 1240, Lenoir City TN 37771. 865-771-2249. email: dan1204us@yahoo.com

The Daily Edition is Loudon County's premier public interest and paid advertising paper. The Daily Edition is produced and published daily Monday through Friday and is circulated throughout Loudon County and parts of Monroe and Knox Counties. Display advertising rates \$5.00 per column inch and quantity discounts available. Call for information on upcoming promotions and events.

HACIENDA *Ayala's*

Mexican Restaurant

Market Dr. * Lenoir City (In Front of Food City)

Real Authentic Mexican Food at Affordable Prices

BEST

MARGARITA

You've Tried The Rest
Now Come Have The Best!!!

We Accept ALL Competitors Coupons Outside of Mexico City!

986-3553

Good Credit OK • Bad Credit OK • Bankruptcies OK • Repo OK

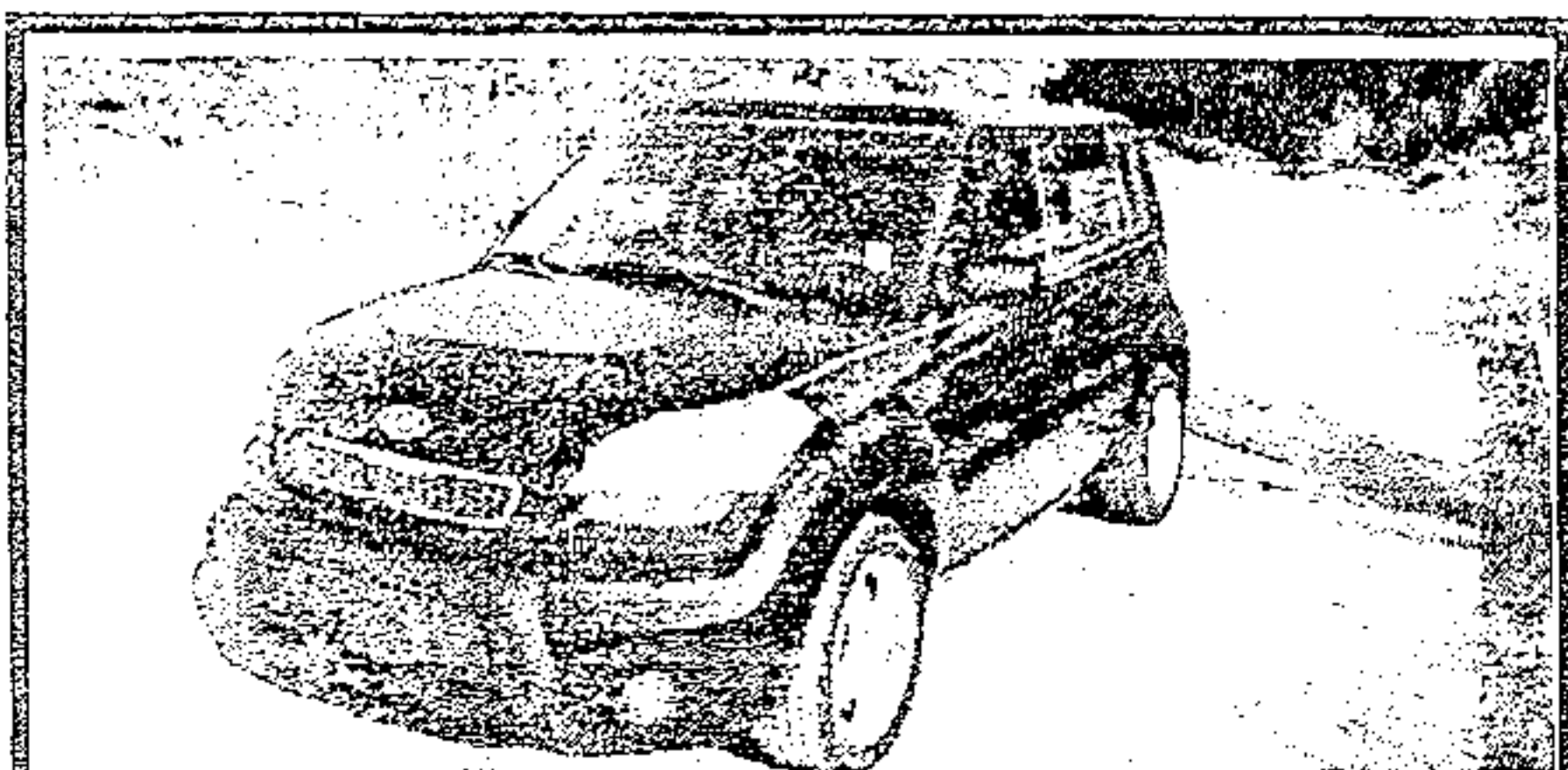

2010 Kia Soul Sporty, 4 cyl, Auto, PW, PL, A/C, Great On Gas, Like New

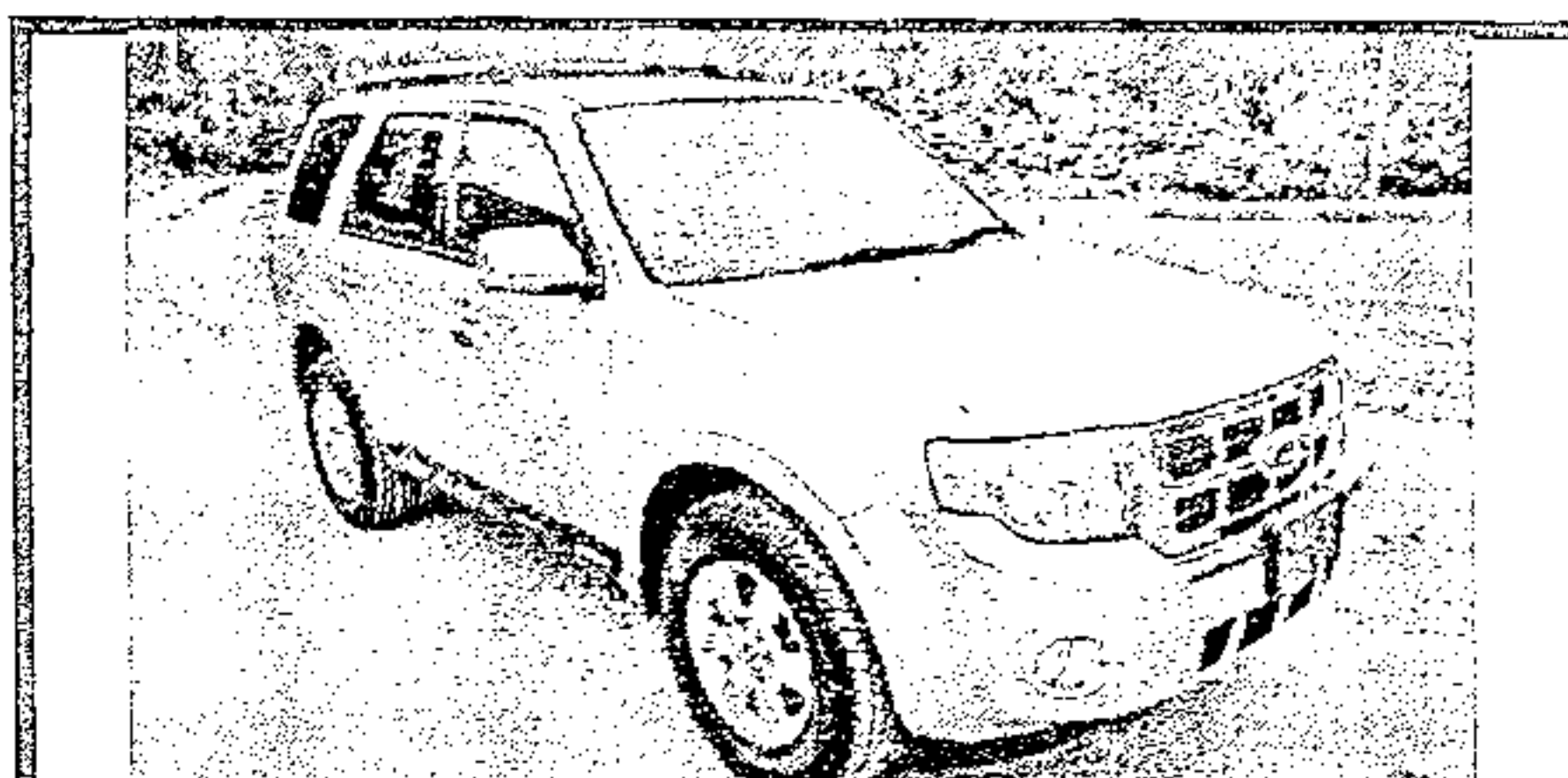

2010 Ford Escape Limited Leather, Alloy Wheels, Heat, A/C, Luggage Rack, 79K,

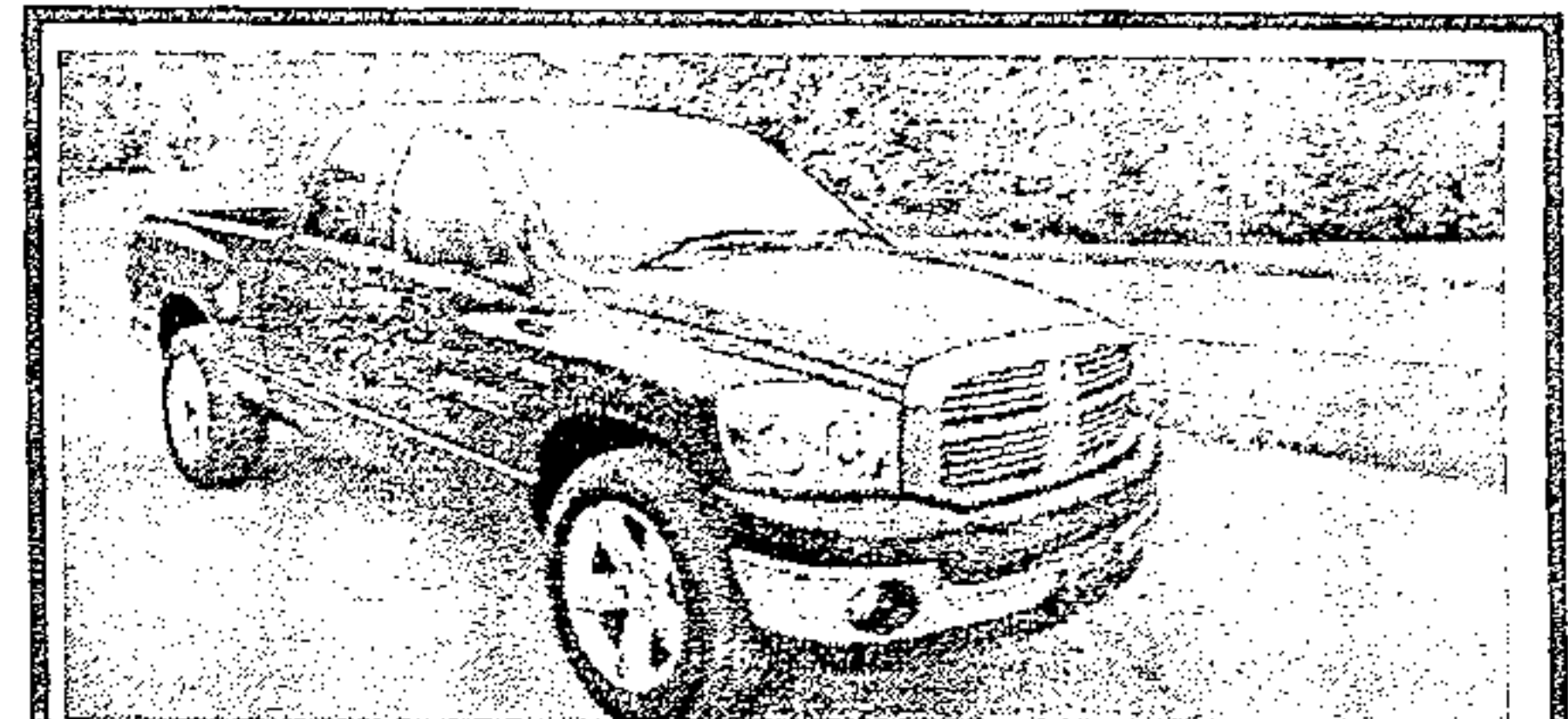

2007 Dodge Ram 1500 Quad Cab, Thunder Road PKG, 20 in. Wheels, Low Miles, Hemi

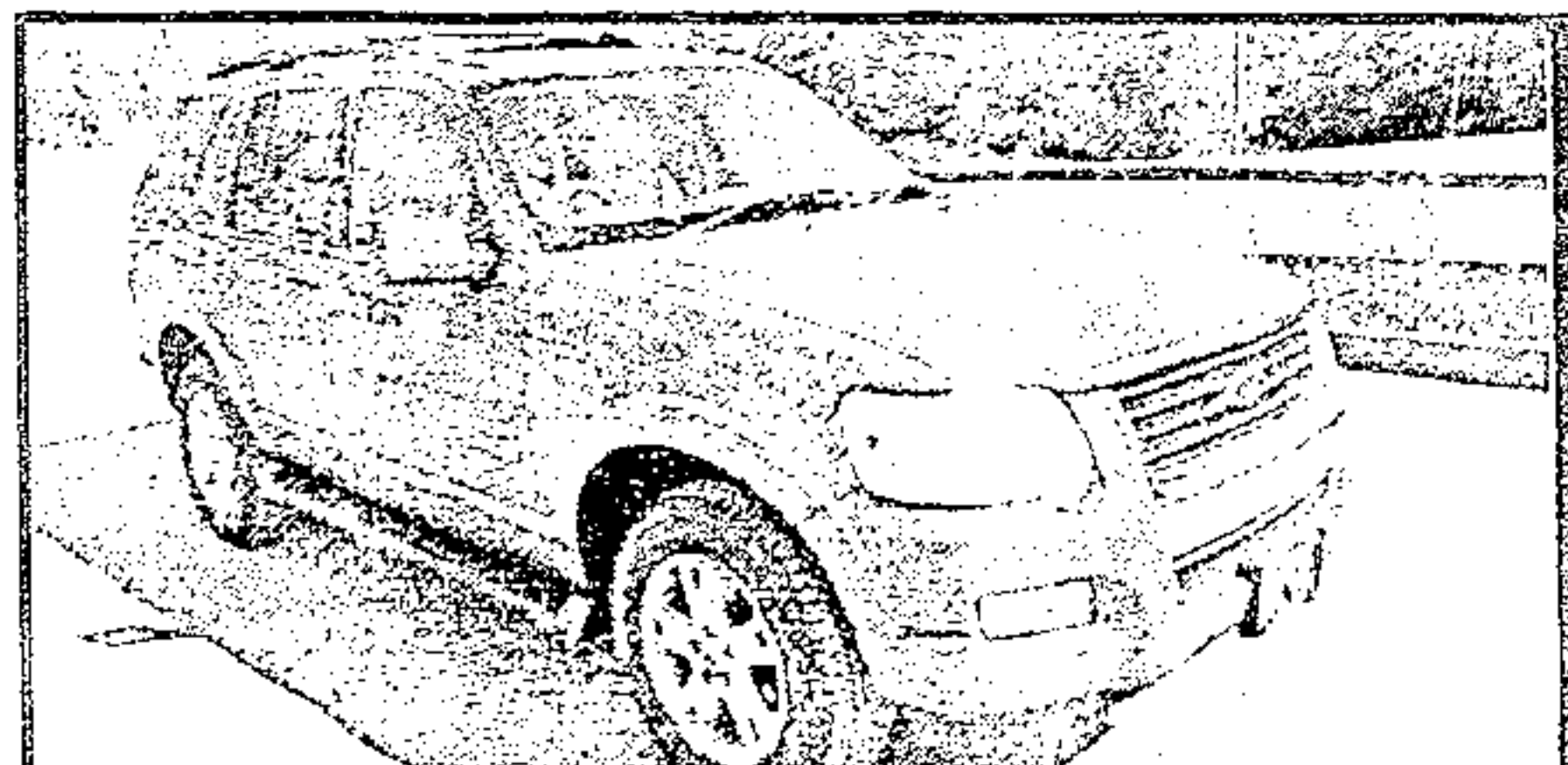

2008 Ford Explorer 84k, 3rd Row Seating, Luggage Rack, Tow Pkg, PW, PL



2011 Ford Ranger Low Miles, Tow Pkg, New Tires, A/C, Heat, Bed Liner.



2011 Dodge Grand Caravan DVD, Stow & Go, Loaded, Remote Doors, Rear A/C

DEPENDABLE MOTORS 986-9343

803 E. Broadway • Lenoir City

* WAC. See Dealer for details

Visit our website at: www.dependablemotorslc.com

Serving Loudon County for 20 Years

PUBLIC NOTICE

Lenoir City Utilities Board Meeting and Lenoir City Council Meeting

The Lenoir City Utilities Board will hold their regularly scheduled meeting on Monday, December 21, 2015 at 4:00 P.M. in the Council Chambers of City Hall, located at 600 East Broadway, Lenoir City, Tennessee 37771. Items to be included on the agenda are as follows:

- Consideration of adopting Resolution approving an Amendment to the Electric System Revenue Anticipation Note, Series 2012, issued by the Lenoir City Utilities Board.
- Consideration of adopting Resolution recommending to the City Council of the City of Lenoir City, Tennessee, the issuance and sale of not to exceed \$10,000,000 in aggregate principal amount of an Electric System Revenue Bond of the City of Lenoir City, Tennessee and recommending the adoption of a Resolution by the City authorizing the issuance and sale of said bond.
- Consideration of approving the 2015 Restatement of the Lenoir City Utilities Board Pension Plan.

The Lenoir City Council will hold a Special-Called Meeting on Monday, December 21, 2015 immediately following the Lenoir City Utilities Board Meeting. The item to be included on the agenda is as follows:

- Consideration of City Council adopting Resolution authorizing the issuance of not to exceed \$10,000,000 in aggregate principal amount of an Electric System Revenue Bond, Series 2015, of the City of Lenoir City, Tennessee; making provision for the issuance, sale, and payment of said bond; establishing the terms thereof and the disposition of proceeds therefrom; providing for the collection and disposition of revenues from the Electrical Power Distribution System of the Municipality; and making provision for the operation of said system.

The public is encouraged to attend.
Thank you.

Obits ctd. from pg. 3

nifer and Anthony Duprey, Sweetwater, Wendy Dunn, Cleveland, Elizabeth Webb and fiancée, Richard Crawley, Sweetwater; grandchildren, Wes, Grant, Abby and Brooke Jenkins, Hannah, Ethan and Kaden Duprey, Jacob and LilliAnna Hamby, Justice Dunn, Katherine Bredwell and Hunter "Speedy" Webb; brother and sister in-law, Eddie and Cynthia Hafley, Athens;

sister, Peggy Decker, Riceville. Services honoring and remembering Martha Kirkland will be held 7:00 PM Monday, Dec. 14th, McGill-Karnes Chapel with Rev. Jeff Jenkins officiating. Interment 11:00 AM Tuesday, Dec. 15th in Loudon County Memorial Gardens, Lenoir City. The family will receive friends 5:00-7:00 PM Monday, Dec. 14th prior to the service at McGill-Karnes Funeral Home, 406 Wharf St.,

Loudon, TN.

Rudy Robert Norris, age 83, of Vonore, TN, passed away Monday, December 14, 2015, at his home. He moved to East TN in 1990 to enjoy fishing, boating, and golf. He also enjoyed traveling and family genealogy. A former member of the Discovery Class at Church Street UMC, he was best known among his friends and family as an avid NY Knicks fan, never missing a single

game no matter what it took to receive the broadcast, and no matter what their win-loss record. Rudy grew up in Gary, Indiana. Upon graduation from Northwestern University, he served in the U.S. Navy. After graduating from Harvard Business School, he enjoyed a long and varied career as an advertising and marketing executive in consumer products, including resident periods in France and Ja-

pan. He concluded his career with Continental Baking Company, thus gaining him the nickname, "Twinkie Pusher." Rudy was preceded in death by parents Elmer Gehrett Norris and Marion (Baumgardner) Norris. He is survived by his wife, Kathleen Blackburn Hethcox Norris; sons Benjamin Norris (Jutta Ulrich) of Phoenix, and Paul Norris (Laura Pasik) of San Francisco; sister Karen Billings (Paul), brother Lisle Norris, Kathleen's children Josh Hethcox (Amy), and Julie Anderson (Matt), four grandchildren, and several nieces and nephews. The family will receive friends Saturday, December 19th from 1:00-3:00 p.m. at Click Funeral Home in Tellico Village. Private inurnment will be held. In lieu of flowers, memorials may be made to: CASA Monroe, 301 College St. N, Madisonville, TN 37354.

LCPD

Kristina Chastain, 19, Browder Hollow Road Lenoir City, was charged with DUI, Driving on Revoked/Suspended License, and Violation of Implied Consent.

Lauren Howard, 18, Riley Drive Lenoir City, was charged with DUI by Consent.

Michael Chastain, 18, Hines Valley Road Lenoir City, was charged with Underage Consumption.

John Koty, 22, Niles Ferry Road Greenback, was charged with Simple Possession.

Officer Bruce Padgett LCPD, observed a red vehicle traveling on Old Hwy 95 with a registration violation.

LCPD ctd. pg. 7

PURDY'S AUTO PARTS AND SALVAGE

WE BUY SCRAP IRON • COPPER • BRASS • ALUMINUM

\$

Paying Top \$\$\$

Call For Latest Prices

You Name It, We Buy It!

Radiators, Wheels, Batteries, Appliances, Farm Equipment

Copper

Paying Top \$\$\$

Call For Latest Prices

You Call We Haul!

423-519-5402



Prices subject to change with the market.

423 337-3977

149 County Road 323 Sweetwater

Complete Cars

per 100 lbs.

Scrap Metal

Paying Top \$\$\$

Call For Latest Prices

per 100 lb

We Buy Batteries

Aluminum Cans

Paying Top \$\$\$

Call For Latest Prices

**Now Selling
Aftermarket
Body Parts at
Discount Prices**

Prices subject to change with the market.

Wreck

According to Lenoir City Police Chief Don White on Tuesday evening just around 10pm a truck reportedly lost control and slammed into the building of Lenoir Medical Clinic on East Broadway.

The office of Dr. Premji was open for business the following day and the building sustained only minor damage compared to the vehicle that slammed into it.

Chief White further reported The truck was driven by a Lenoir City man identified as Richard DeLoach, 55 of Lenoir City. Mr. DeLoach is a life long resident of Lenoir City who was pronounced

dead at the scene. Lenoir City Police and Fire Department responded and handled the investigation and cleanup of the scene.

The investigation is ongoing according to Chief White and he stated there were no signs of alcohol or drugs at the scene and it did not appear foul play was involved at this time either. The final determination will be made when the results of the autopsy come back.

Lenoir City Police Department as well as Lenoir City Fire Department were on the scene so fast it could barely be timed but for those who must know the response times were less than 3 min-

utes.

Lt. David Flynn, Sgt. Jeremy Dishner, and Officer Brandon Gentry and a host of others were on scene.

LCPD ctd. from pg. 5

Officer stopped the vehicle at Foothills Drive and made contact with the driver Kristina Chastain, and passengers Michael Chastain, Lauren Howard, and John Koty. Officer could smell a strong odor of alcoholic beverage coming from Kristina person. Kristina was ask to perform sobriety test which she did poorly on and placed under arrest. The owner of the vehicle Lauren Howard gave permission to search and a plastic

baggie with a green leafy substance believed to be marijuana was located beside the passenger seat. John Koty stated the marijuana was his. Lauren did state to Officer she knew Kristine had been drinking and still allowed her to drive. all parties were placed under arrest. Officer Bruce Padgett LCPD, made the arrest.

slaves ctd. from pg. 2

quickly. But four individuals were anxious to proceed—and willing to pay thousands of dollars for a sex slave. "All of them said this was something they had wanted to do for a long time," Blay said.

The undercover operative told the four buyers he was connected to a

human trafficking group that would identify foreign females in the U.S. on temporary visas, kidnap them, and sell them into a life of slavery. The operative also said his organization held a biannual auction, where the women would be sold to the highest bidders.

The four individuals—two from Arizona, one from Montana, and one from California—were in their 50s and 60s. One was an engineer with a Top Secret government clearance. Another was a financial analyst. The Montana man was going to pay \$10,000 for two women. When he flew to Phoenix in May 2014 to make the purchase, he was carrying u-bolts to bind the women's wrists and gags to keep them

(see slaves ctd. pg. 8)

LOOK!
\$75 Weekly Payments
LOOK!

MARTY'S AUTO SALES • 986-2222
MARTY'S AUTO SALES • 986-2222
MARTY'S AUTO SALES • 986-2222
MARTY'S AUTO SALES • 986-2222
MARTY'S AUTO SALES • 986-2222

Bad Credit

Divorce

Fixed Income

Repos

Bankruptcy

No Credit

APPROVED!

Visit Us On The Web At:

marty'sautosales.net

NO

CREDIT

CHECKS

\$499 down*

07 Cobalt, 5spd, gas saver, runs great Only \$499 down*

\$499 down*

02 Sable, sunroof, loaded, Only \$499 down*

\$499 down*

04 Cavalier, 2dr, Sporty, Only \$499 down*

\$499 down*

01 Sebring 2dr. sporty, Only \$499 down*

\$299 down*

00 Civic, auto, Gas Saver, Only \$299 down*

\$399 down*

06 PT Cruiser, auto, gas saver, Only \$399 down*

\$399 down*

04 Stratus, 4 cyl, Runs good, Only \$399 down*

\$99 down*

98 Bonneville, 6 cyl, Auto, low payments only \$99 down*

NO Credit Checks

Marty's Auto Sales

986-2222

*See Dealer for details. All down payments plus tax, tag, title and fees.

Se Habla Español

100% Approval*

MARTY'S AUTO SALES • 986-2222
MARTY'S AUTO SALES • 986-2222
MARTY'S AUTO SALES • 986-2222
MARTY'S AUTO SALES • 986-2222
MARTY'S AUTO SALES • 986-2222

slaves etc., from pg. 2

quiet. He planned to transport them back to Montana in a recreational vehicle. The man told the undercover operative he had a fully functional dungeon in the basement of his home.

“When we eventually conducted searches,” Blay said, “all the subjects had basically manufactured rooms in their homes to be prison cells. There were bars on windows, obscured glass, and insulation so no one could see or hear the women from the outside. One guy bolted chains

in the floorboards of a room.”

The four men were indicted on human trafficking charges between December 2013 and May 2014. They all pled guilty, and in September 2015, an Arizona federal judge sentenced them to prison terms ranging from seven to nine years.

“We are extremely pleased that we were able to intervene before any of these individuals was able to hurt anyone,” Blay said. “We didn’t want to wait until there were actual victims.”

A Name You Already Know And Trust Just Got Even More Dependable
DEPENDABLE AUTO SERVICE, LUBE AND TIRES
 Is Now Offering
Expert, Affordable Transmission Service
 All ASE Certified Technicians

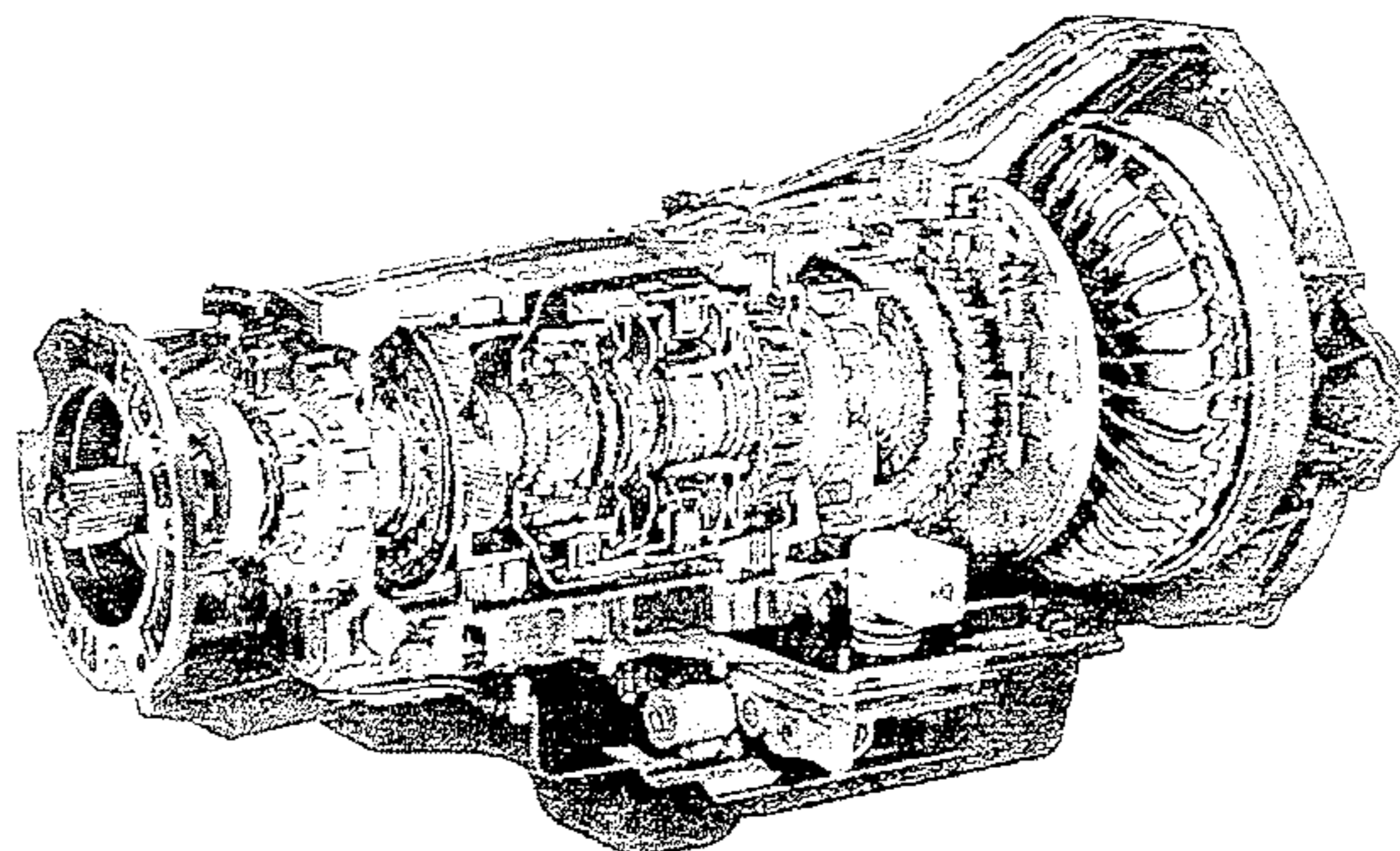

We proudly welcome all New Customers and Former Advanced Transmission Customers with a 10% Discount and Any Transmission Service or Repair*

865-986-9359

865-986-5050

Is Your Washer Broken?

Call Me

I Only Charge \$100 Period!!!

Call Allen

865-617-7113

Bad Credit, No Credit OK!!! We Finance Everybody!!!

Low Down Payment!!!

Over 100 Cars, Trucks & Vans in Stock - Warranties On ALL Vehicles Sold!!!

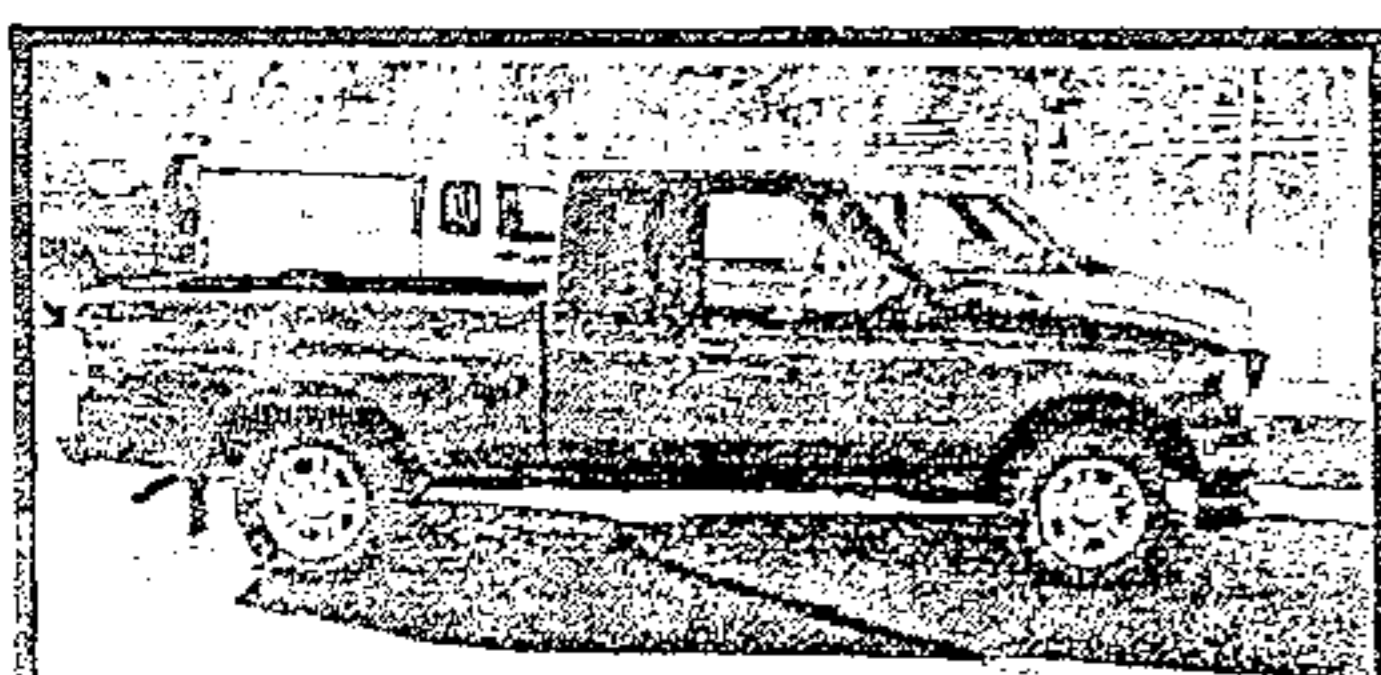

2005 Ford Ranger, Super Nice Truck, Very Low Miles

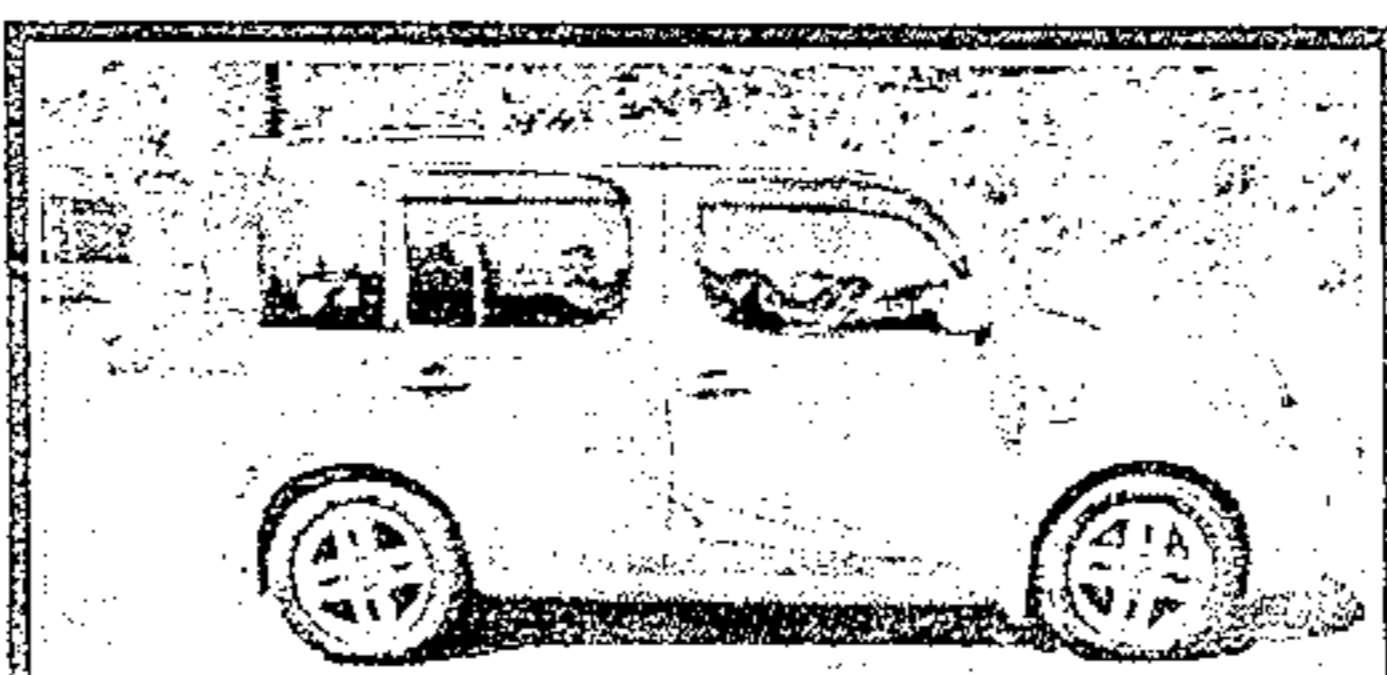

2009 Nissan Cube, Great Gas Saver, Clean

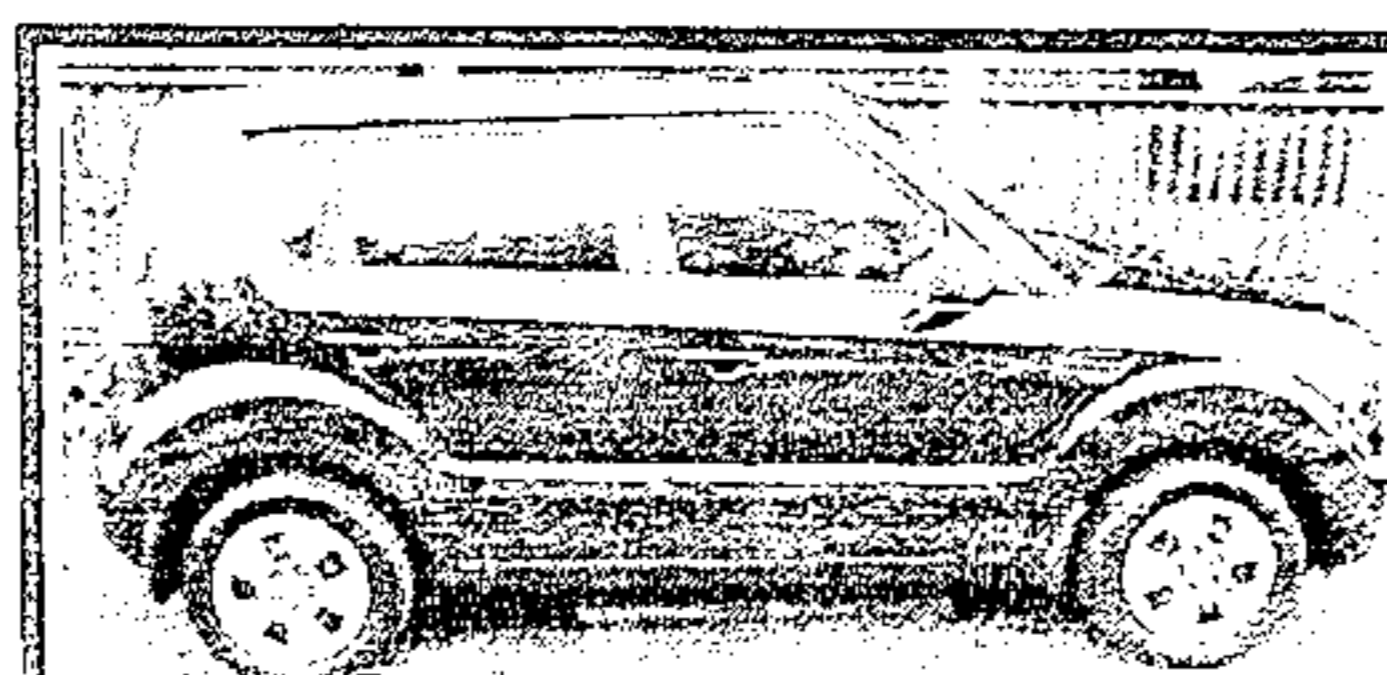

2011 Kia Soul, 5 speed, 4 dr, Gas Saver, Nice & Clean

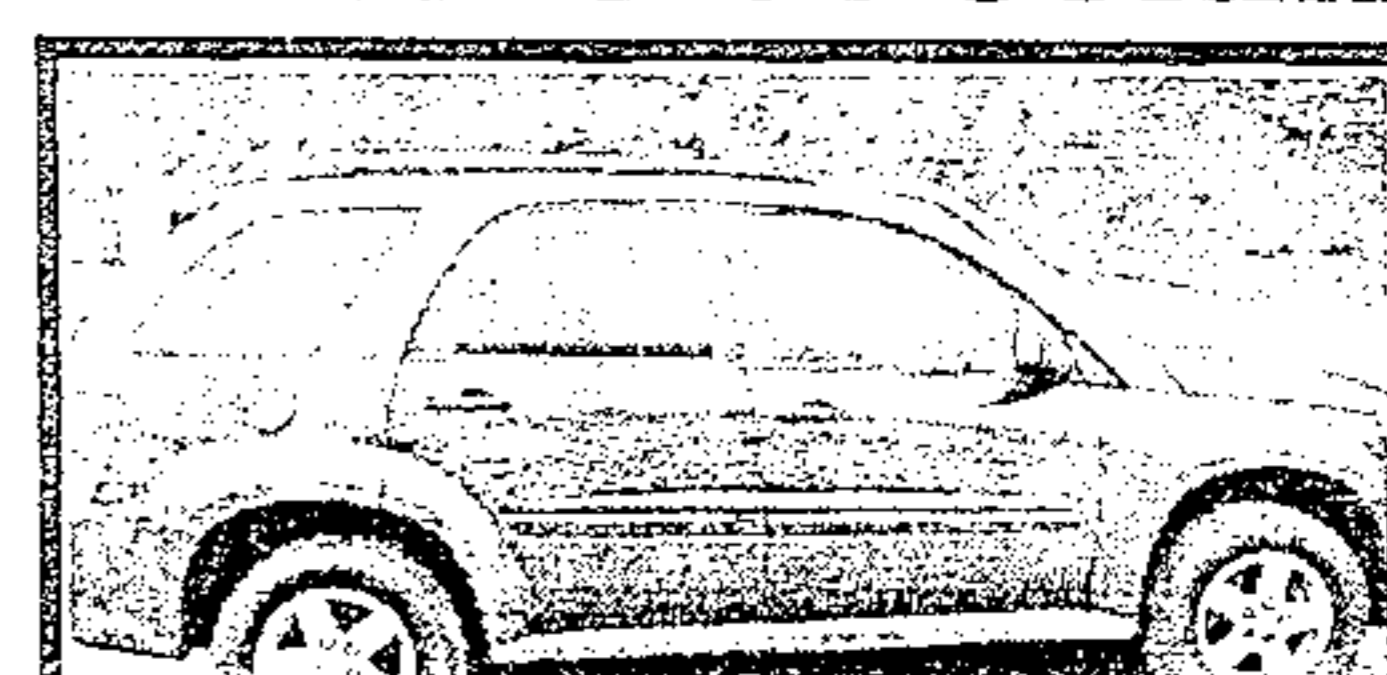

2007 Chevy Equinox, 4dr, Extra Clean, lots of room

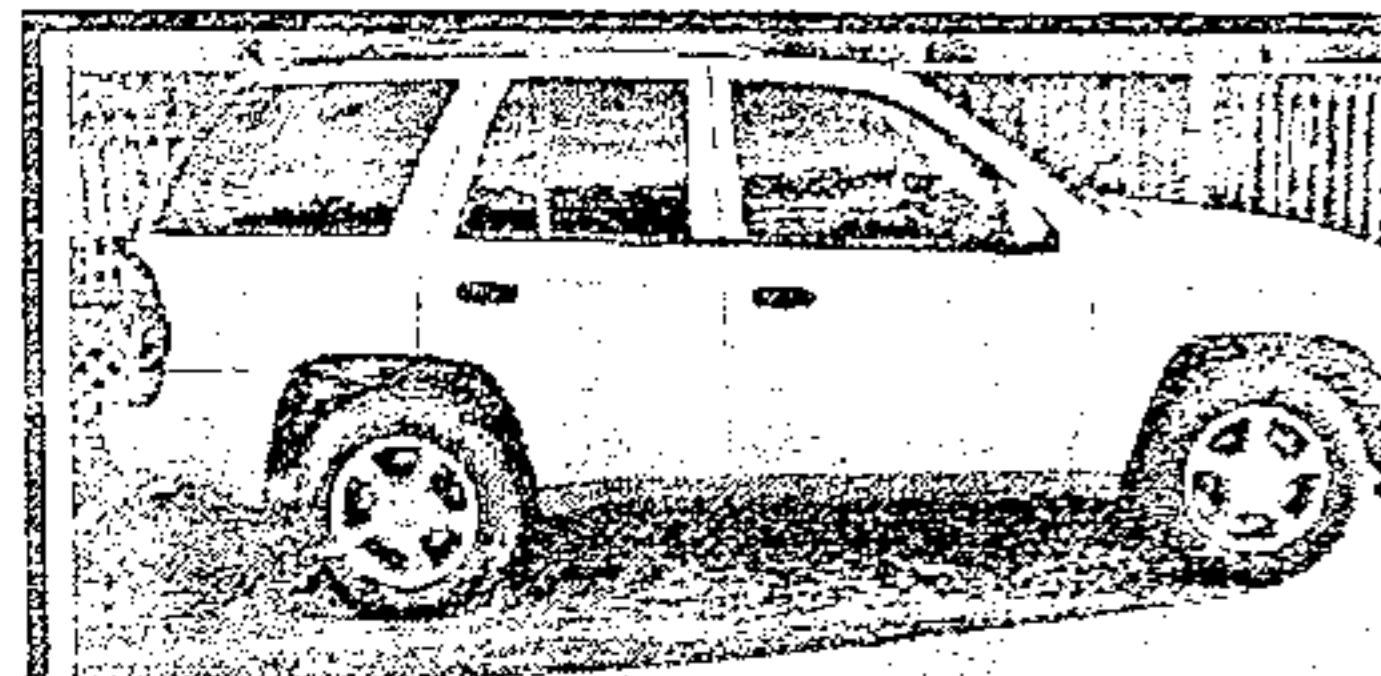

2008 Chevy Trailblazer, NICE! Loaded

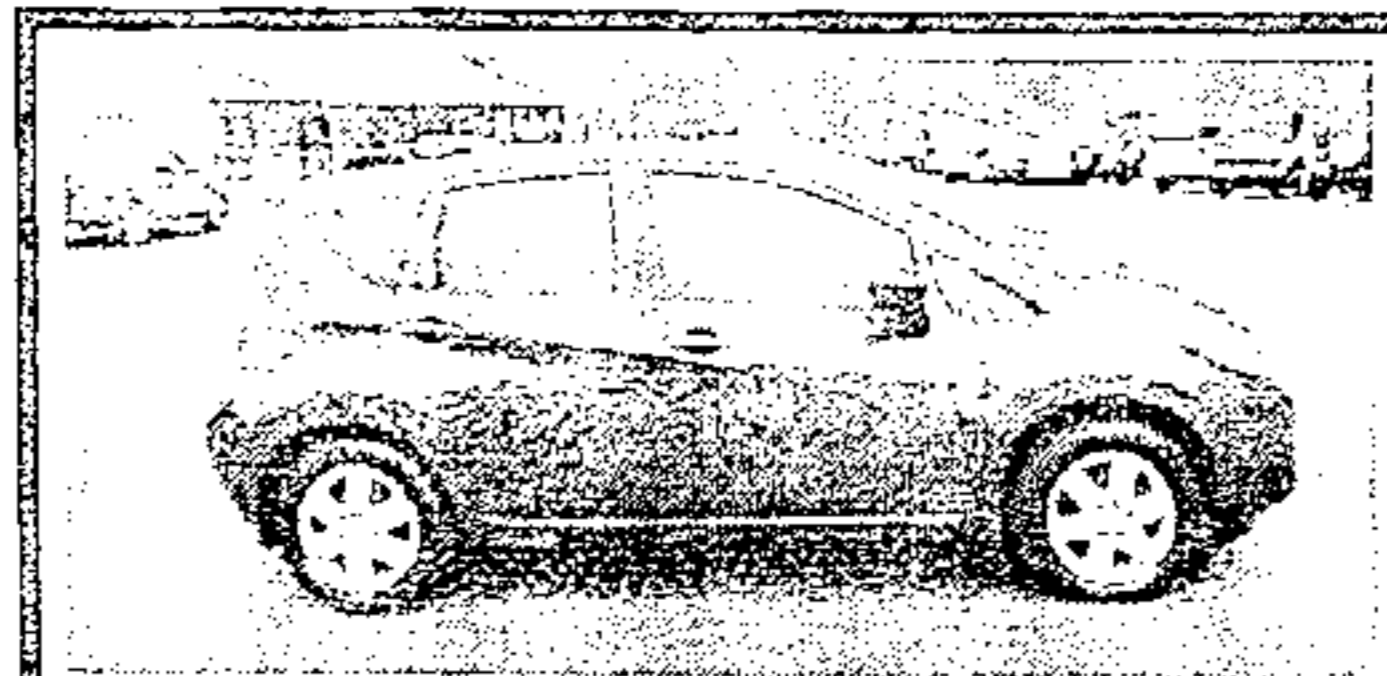

2015 Versa Note, ONLY 19k miles!, Factory Warranty!

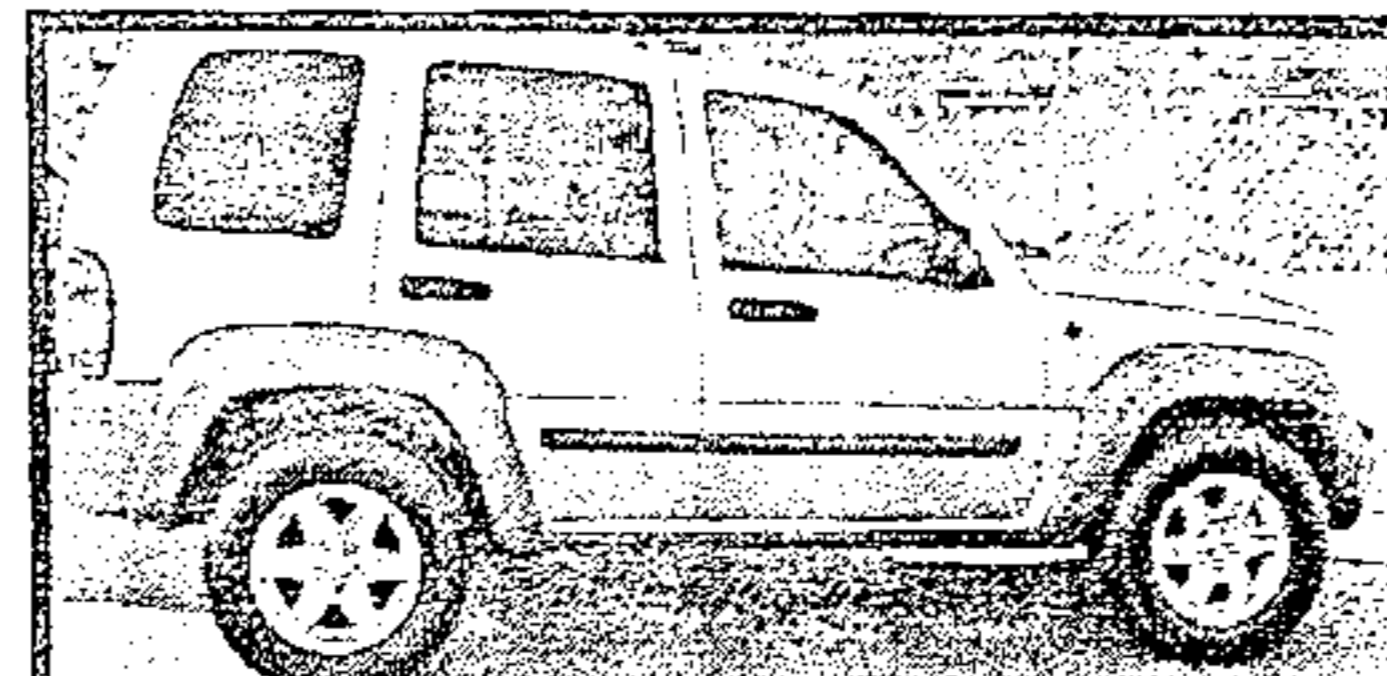

2004 Jeep Liberty, Nice, Extra Clean

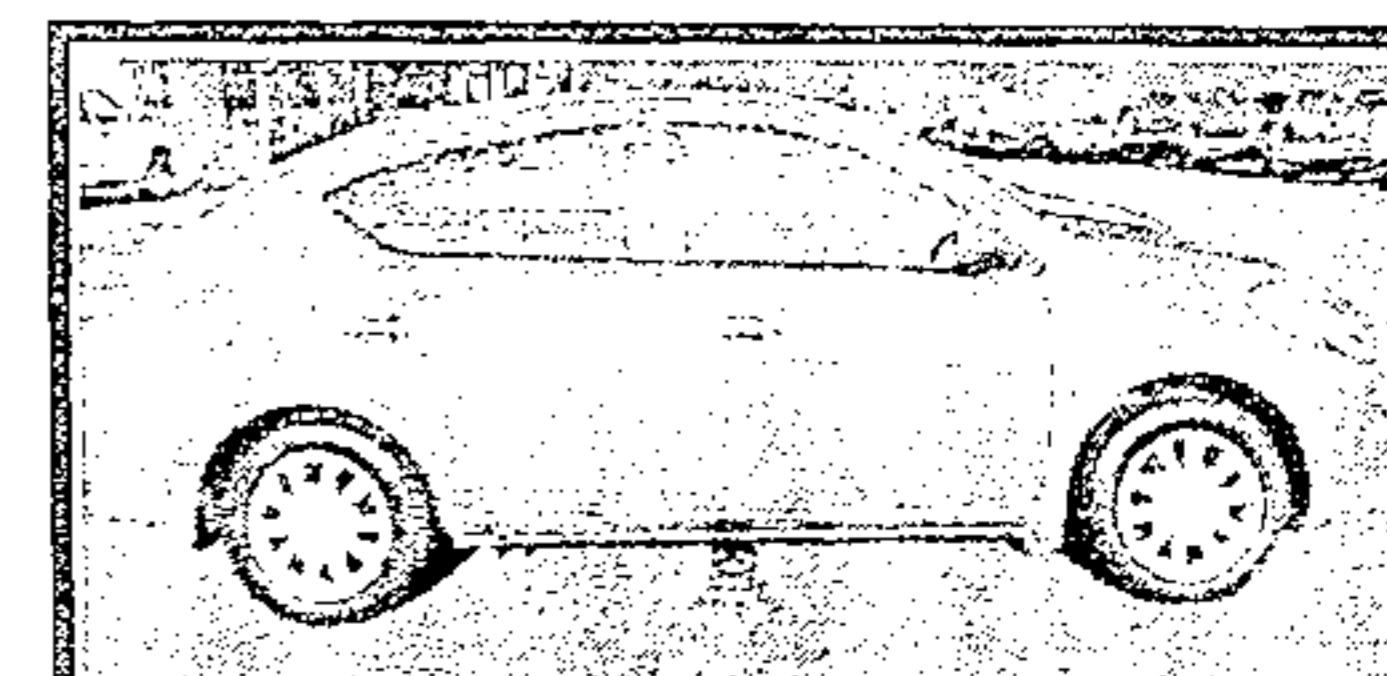

2013 Nissan Versa, Like New! LOADED!!!

WALT WILLIAMS, INC.

*with approved credit

3003 Highway 11

Lenoir City, TN

865-986-1111