

# The Daily Edition

50¢

Serving Loudon, Monroe and Surrounding Counties

Wednesday, December 16, 2015

## Update: Five Charged in Kidnapping and Attempted Murder Case following shooting



Jeremy Patrick



Michael Goff



Randal Bledsoe



Donette Hightower



Cheyanna Suddath

cause he was going to call the law. Approximately three shots from a small hand gun were fired towards both victims. Victim 1 did advise that the suspect was tall, skinny, bald, with a neck tattoo that matched both descriptions of Randall Bledsoe and Jeremy Patrick. Victim 1 also advised

that the suspect was wearing a camo/flannel shirt jacket. Victim 1 then said all three men ran away from his residence with the suspect(s) leaving in a dark colored SUV and a red Ford Mustang.

Contact was then made with victim 2 by Deputy Brian Smith LCSO.

(see Update pg. 7)

## Timothy Chesser sentenced for methamphetamine manufacturing conspiracy

On Dec. 14, 2015, Timothy Chesser, 35, of Harriman, Tenn., was sentenced to serve 240 months in prison, by the Honorable Pamela L. Reeves, U.S. District Judge, for conspiracy to manufacture 50 grams or more of methamphetamine (meth) and possession of precursors used to manufacture meth.

Upon his release from prison, he will be supervised by the U.S. Probation Office for 10 years. His federal sentence is consecutive to any Roane County, Tennessee state sentence he may receive for pending charges.

Chesser was charged along with several others in a July 2014 indictment. He pleaded

Deputy Charlie Parker LCSO, responded to Mountain View Road on a shots fired call. Contact was then made with victim 1 who said that a man he identified as victim 2 had been knocking on his door. Victim 1 then told victim 2 that he needed to leave, at which time, two other men walked up from the a residence of Mountain View Road. Victim 1 then told everyone to leave be-

### Verse of the Day

Do everything without complaining or arguing, so that you may become blameless and pure, children of God without fault in a crooked and depraved generation, in which you shine like

stars in the universe. — Philippians 2:14-15

### Obituaries

see inside

### Wazzup

A Big Shout Out To Mason Braswell, sure hope you have a great cross country trip and get to

see lots of cool stuff!

### Weather

Today: Intervals of clouds and sunshine. High near 70F.

Tonight: Rain showers in the evening will evolve into a more steady rain overnight. Low 53F.

Thursday Cloudy and damp with rain in the morning...then becoming partly cloudy. High 58F. Thursday Night Some clouds early will give way to generally clear conditions overnight. Low 34F.

(Continued on page 6)

(see meth pg. 2)



PI  
 guilty to the offenses described above in August 2015. According to documents on file with U.S. District Court, between 2012 and 2014, Chesser conspired with at least one other person to manufacture and distribute at least 50 grams of meth in various locations in east Tennessee.

see. According to pharmacy records and the statements of others, he purchased, or had others purchase for him, pseudoephedrine that he used to manufacture meth.

This case was investigated by the Roane County Sheriff's Office, Harriman Police Department, Rockwood Police Department, Kingston Police Department, Tennessee

Bureau of Investigation, and Federal Bureau of Investigation. Assistant U.S. Attorney Brooklyn Sawyers represented the United States.

**Dependable Motors**  
 865-986-9343

**Notice**  
 Vin 1B7HU18Z82J104653  
 2001 Dodge Ram will be sold. If anyone has a lien on this vehicle contact: Money-maker Wrecker Service 11776 Hwy 70 E, Lenoir City 37772. 865-986-5518

Notice: The Daily Edition does not knowingly accept fraudulent or misleading materials. The Daily Edition cannot guarantee the validity of offerings or statements contained herein. All liability for the contents of all advertising, and for any claims that may arise therefrom, is the responsibility of the advertiser or its agency. The Daily Edition reserves the right to reject, edit, or abbreviate any advertisement submitted. Advertising is accepted with the understanding that all liability for all copyright violations is the sole responsibility of the advertiser. Photographs, artwork and other copy submitted for publication is considered the sole property of the advertiser. The Daily Edition will make every effort but will not be liable for failure to publish and ad or for typographical and layout errors. All statements and information about highlights featured items, letters to the editor, herein are those solely given to the interviewer or writer and the Daily Edition assumes no responsibility of the accuracy or validity thereof. The Daily Edition will gladly reprint at no charge that part of an advertisement in which an error occurs provided a claim is made within 3 days of the first publication of the ad. Information contained in the Wazzup is received anonymously and the Daily Edition assumes no responsibility for information and reserves the right to edit or reject any and/or all submissions. The Daily Edition is a daily newspaper of general circulation in Loudon County defined under TCA 2-1-104(a)(13). The Daily Edition also serves Monroe, Knox, Anderson, Roane and Blount counties and serves 30,000 readers weekly. Send mail to PO Box 1240, Lenoir City TN 37771. 865-771-2249. email: dan1204us@yahoo.com  
 The Daily Edition is Loudon County's premier public interest and paid advertising paper. The Daily Edition is produced and published daily Monday through Friday and is circulated throughout Loudon County and parts of Monroe and Knox Counties. Display advertising rates \$5.00 per column inch and quantity discounts available. Call for information on upcoming promotions and events.

**HACIENDA Ayala's**  
 Mexican Restaurant  
 Market Dr. \* Lenoir City (In Front of Food City)

**Real Authentic Mexican Food at Affordable Prices**

**BEST MARGARITA**

You've Tried The Rest  
 Now Come Have The Best!!!

We Accept ALL Competitors Coupons Outside of Mexico City!  
 986-3553



**Good Credit OK • Bad Credit OK • Bankruptcies OK • Repo OK**



2010 Kia Soul Sporty, 4 cyl, Auto, PW, PL, A/C, Great On Gas, Like New



2010 Ford Escape Limited Leather, Alloy Wheels, Heat, A/C, Luggage Rack, 79K,



2007 Dodge Ram 1500 Quad Cab, Thunder Road PKG, 20 in. Wheels, Low Miles, Hemi



2008 Ford Explorer 84k, 3rd Row Seating, Luggage Rack, Tow Pkg, PW, PL



2011 Ford Ranger Low Miles, Tow Pkg, New Tires, A/C, Heat, Bed Liner.



2011 Dodge Grand Caravan DVD, Stow & Go, Loaded, Remote Doors, Rear A/C

**DEPENDABLE MOTORS 986-9343**  
 803 E. Broadway • Lenoir City

*Serving Loudon County for 20 Years*

\* WAC. See Dealer for details

Visit our website at: [www.dependablemotorslc.com](http://www.dependablemotorslc.com)

### Charges follow domestic call

Robert Duffy, 48, Castaway Lane Lenoir City, was charged with Domestic Assault.

Deputy Jimmy Yoakum LCSO, was dispatched to the gate house at Wind River in Loudon County. Upon my arrival Deputy spoke with the victim. The victim stated after a dinner party at the Wind River Manor, she and her fiance, Robert Duffy, began arguing in his car. Victim stated she wanted to get out of the car and she took off her seatbelt. She then said Mr. Duffy slammed on the brakes of the car causing her to strike her head and injure her neck. She then stated that

Mr. Duffy got out of the car and told

her to get out. At this point, victim stated Mr. Duffy grabbed her by her throat and began squeezing very hard. She stated he then pushed her very hard and almost made her fall. This occurred on Lighthouse Pointe Drive. Victim stated she got back in the car and asked him to

take her home where they reside together. Victim stated while at the house, she began to gather her things to leave and Mr. Duffy began arguing with her again. She stated while she was in the laundry room, Mr. Duffy pushed her, forcefully, to the floor. Victim stated she went to her car and began to

leave the residence to go to the gate house to call the sheriffs office. When she was leaving, Mr. Duffy allegedly threw something at her car. She stated she heard a loud bang but she kept driving. Victim stated Mr. Duffy followed her in his car and attempted to block her path. She reached the gate house and the gate guard, stated he was going to call the police. Mr. Duffy then went back to their residence.

Deputy then went and talked to Mr. Duffy at Castaway Lane. Mr. Duffy stated they had argued and victim had continually struck him and would not calm down. Mr. Duffy stated victim struck him with a belt in the closet. Mr. Duffy stated they had also argued in the laundry room and he had to push victim down to stop her from striking him. He stated when victim left he did throw his cell phone at her car to stop her from driving.

The victim's mother stated she heard the two arguing and looked downstairs and saw victim laying in the floor after she heard a loud crash. Deputy observed two red marks on the left side of victims neck, as well as what looked

**SARCO Enterprises Inc. Offers Complete Home and Commercial Remolding and Repairs**

Our Team members have a combined total of over 40 years experience in all areas of home construction, facilities maintenance and commercial construction. Roofing, Electrical, Bath and Kitchen Renovations, we do it all with just one call. We are fully insured and our work is guaranteed.

Call us today for a free no obligation quote for your next project.  
865-809-9492.

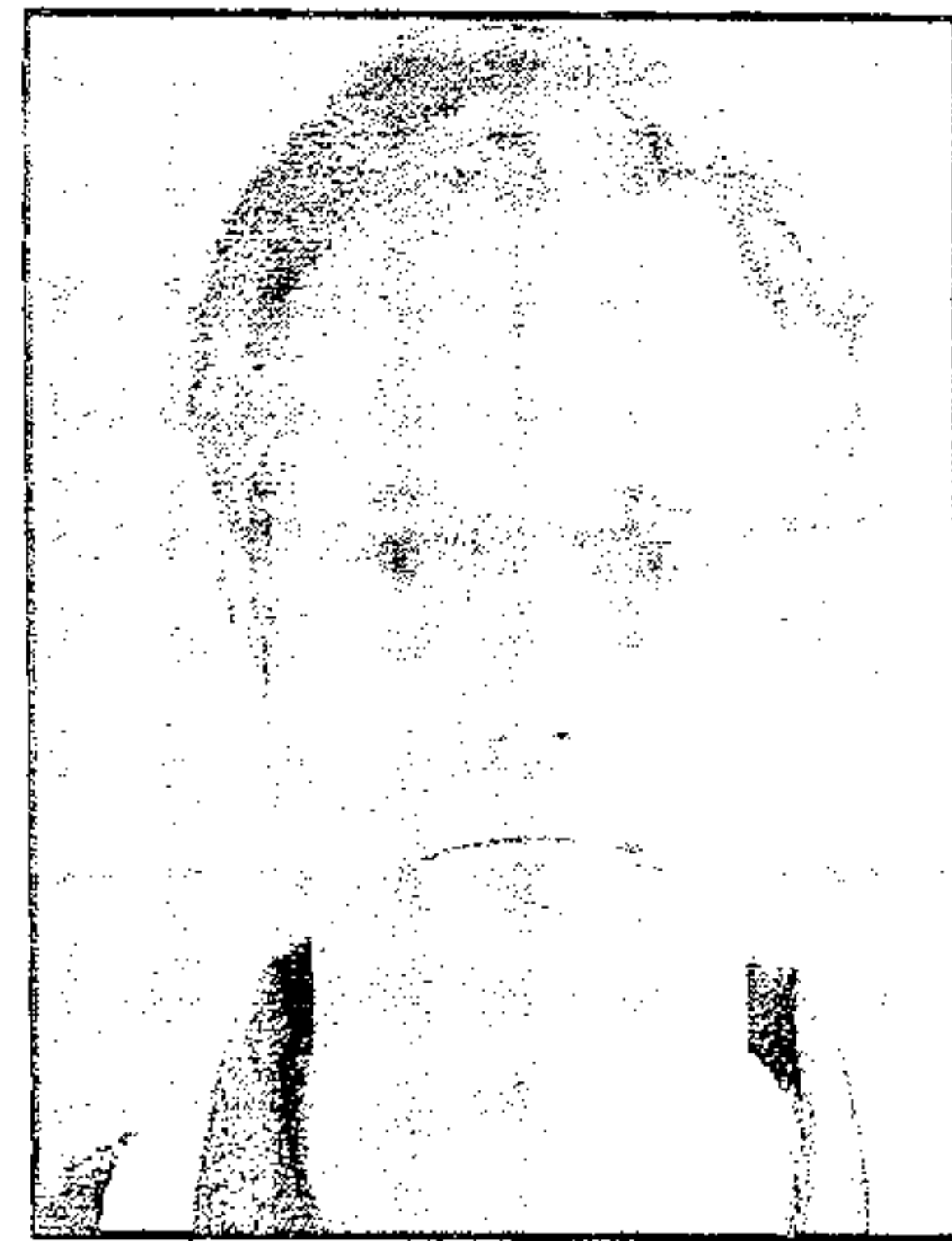

Robert Duffy

(see DV ctd. pg. 5)

# BUDGET Transmissions

302 S. Northshore Drive Knoxville

(865) 584-4391

## Why Buy From Budget?

Free Towing From Lenoir City or Loudon County

20 Years of BBB Zero Customer Complaints Award Member

A+ Plus Rated

Huge Transmission Inventory Best Technicians Period!!!

Call (865) 584-4391 Today!

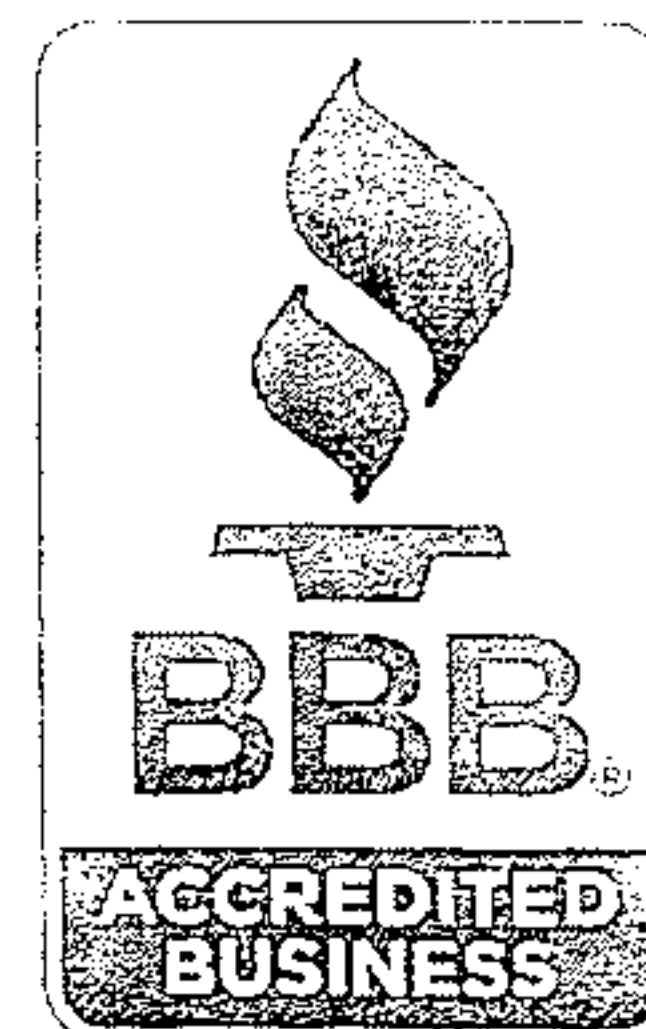
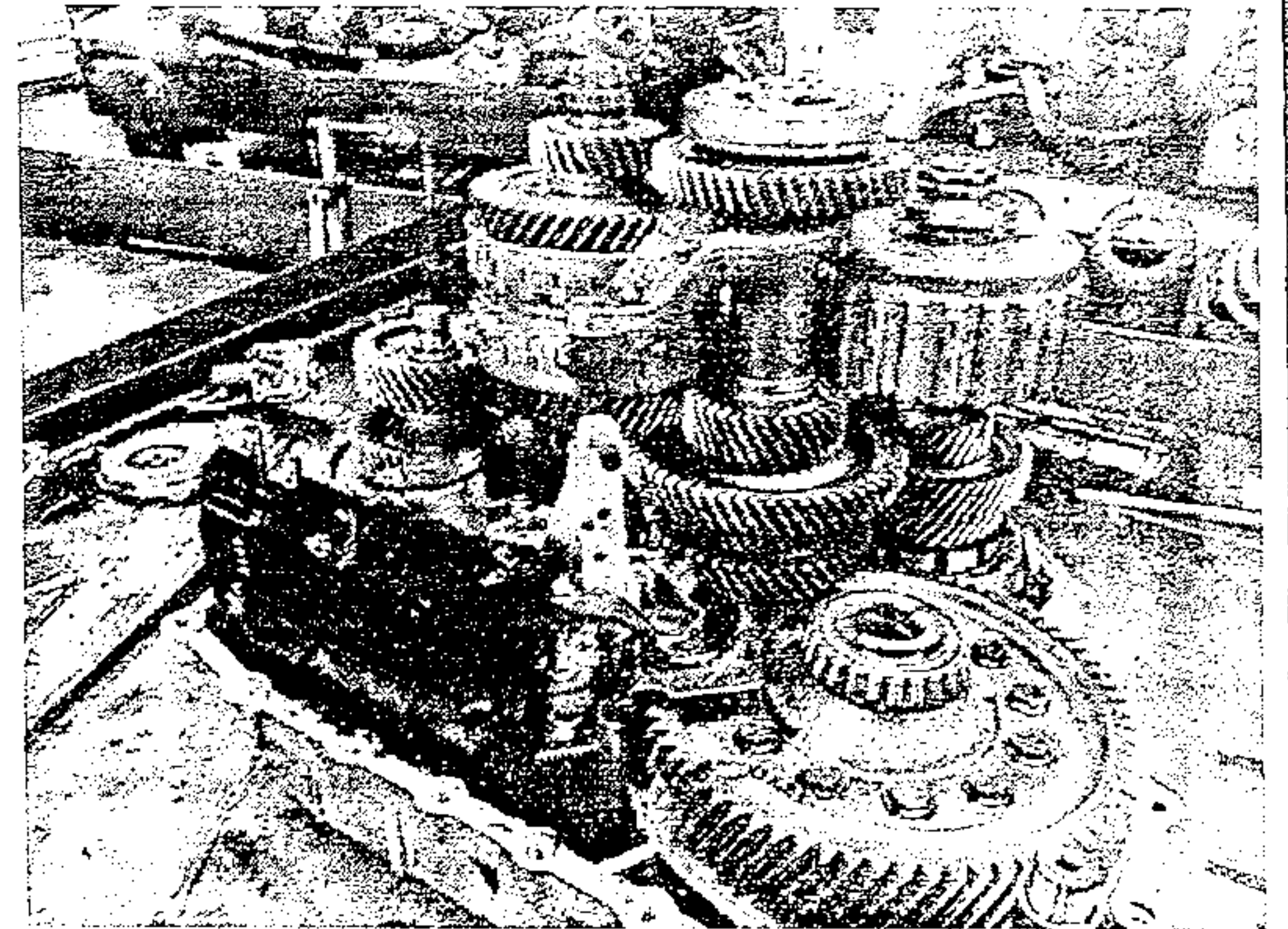

budget-transmissions.com



Obits ctd. from pg. 3  
ing. Family and friends will meet at the funeral home by 10:30 a.m. on Tuesday and proceed to Pleasant Forest Cemetery in Farragut for 11 a.m. Graveside Services.

Rosie Lynn Goforth - age 68 of Lenoir City passed away Monday morning, December 14th at her home. Rosie was a member of Lee Heights Baptist Church. She was preceded in death by her husband, Carl P. Goforth, Sr. ; son, Roger Dale Goforth; good friend, James Paul Norton; father and mother, James and Iva Kagley; brother, Tommy Kagley; sister, Betty Haage, and a baby brother. Survived by her sons, Carl P. Goforth, Jr. (Amy), and Gary L. Goforth; daughter, Tammy S. Johnson (Wayne); special daughter, Glacia M. Goforth; grandchildren, Maranda, Nathan, and Michael Goforth and Brooke Spires; great-grandchildren, Broderick and Callista Hardin; sister, Christine (Larry) Currier; brother, Richard Kagley; several nieces and nephews. The family would like to express a special thank you to Thompson Cancer Center for their special care. The family will receive friends from 5 to 7 p.m. Tuesday, December 15th at Click Funeral Home in Lenoir City. Funeral services will follow at 7 p.m. with Rev. Doug Kizer and Rev. Shane Williams officiating. Family and friends will gather at the funeral home by 10:30 Wednesday morning and proceed to the Lakeview Cemetery for graveside services at 11 a.m.

Wanda L. (Jenkins) Willett, 76 of Loudon passed away Saturday, December 12, 2015. Wanda was a retired nurse and preceded in death by; parents, Mack and Mary (Oody) Jenkins, brother, Allen "Bud" Jenkins. Survivors, husband, Jimmy Willett, brother, Bill Jenkins of Loudon, nieces, Lisa Kirkland and Tiffany Wilkerson of Maryville and family. And numerous extended family and friends. Funeral service 7 p.m. Tuesday Loudon Funeral Home chapel with Rev. Bob Kerr officiating. Graveside services 11 a.m. Wednesday at Corinth Cemetery with Rev. Bobby Lawson officiating. Family will receive friends from 5 p.m. to 7 p.m. Tuesday at Loudon Funeral Home. [www.loudon-funeralhome.net](http://www.loudon-funeralhome.net)

DV ctd. from pg. 4  
like a small amount of yellowish, discoloration to the front of her neck area. Deputy also observed a large scratched area on the rear, drivers side door of her car. Deputy observed a small red area on Mr. Duffy's left, outer forearm. Mr. Duffy's cell phone was damaged also.  
Based on the investigation, Deputy determined Mr. Duffy to be the primary aggressor and placed him under arrest for Domestic Violence. Deputy then transported him to jail without incident. All the above occurred in Loudon County. Deputy Jimmy Yoakum LCSO, made the arrest.

# PURDY'S AUTO PARTS AND SALVAGE

WE BUY SCRAP IRON • COPPER • BRASS • ALUMINUM

**\$** **Paying Top \$\$\$**  
**Call For Latest Prices**

**Complete Cars**  
**per 100 lbs.**

**Scrap Metal**  
**Paying Top \$\$\$**  
**Call For Latest Prices**  
**per 100 lb**

*You Name It, We Buy It!*  
*Radiators, Wheels, Batteries, Appliances, Farm Equipment*

**Copper**  
**Paying Top \$\$\$**  
**Call For Latest Prices**

**We Buy Batteries**  
**Aluminum Cans**  
**Paying Top \$\$\$**  
**Call For Latest Prices**

**You Call We Haul!**  
**423-519-5402**

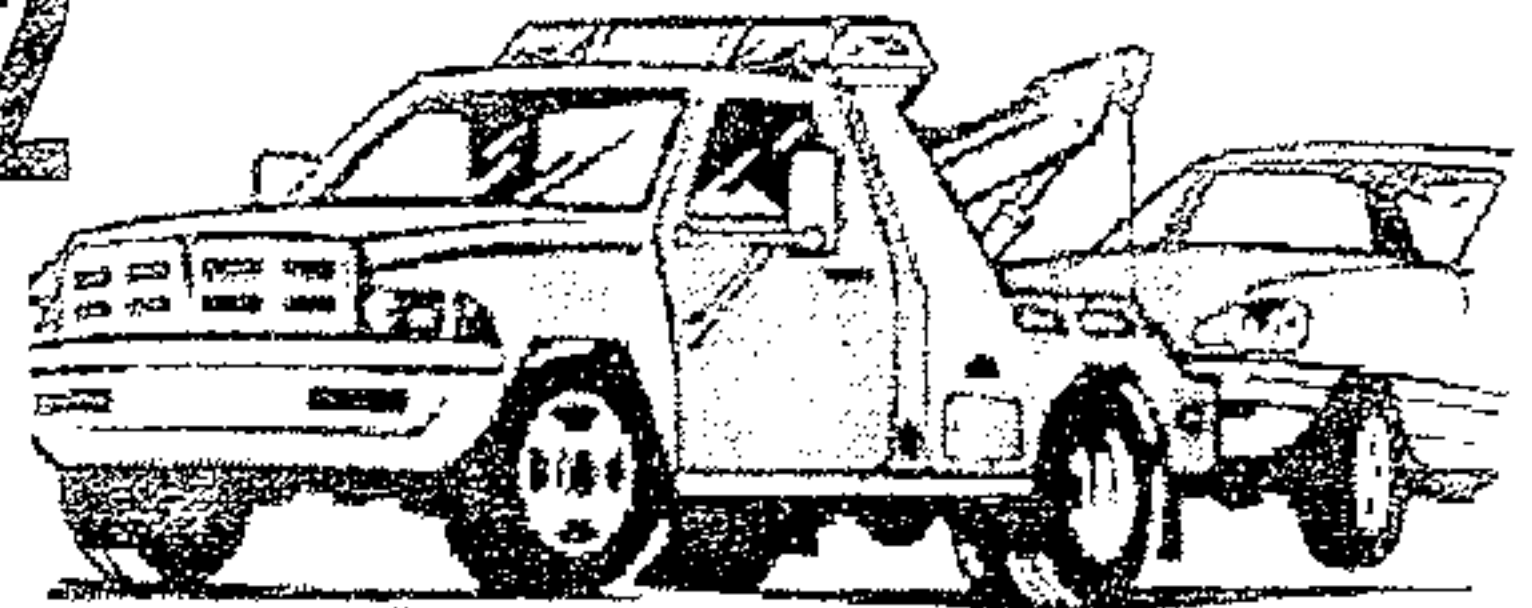

Prices subject to change with the market.

**Now Selling**  
**Aftermarket**  
**Body Parts at**  
**Discount Prices**

**423 337-3977**  
**149 County Road 323 Sweetwater**

Prices subject to change with the market.

**Update**

Victim 2 advised in his written statement that he was at Mountain View Road going through yardsale items. A dispute arose about a diaper bag missing, resulting in a physical scuffle. Victim 2 then claimed to be held inside the living room by a man with a gun. After a short time, victim 2 noticed the front door was open and ran across the street to Mountain View Road to ask for help. Two men followed him and fired three or four shots. The gun then that while attempting to exit the truck he accidentally fired one round possibly jammed and the two

men ran away. Victim 2 then returned to his residence of Clark Road.

There were no shell casings discovered on scene. The three locations of the bullets fired into Mountain View Road were: the top left corner of the large window in the front of the house which went into an interior wall, the bottom right corner of the same window, and the wooden porch rail which hit the brick behind it. The damage of the window was valued at approximately \$800.00 by victim 1. There were no injuries advised of by the victims. At the time of the report, the shooter was not positively identified or located at that

time. A short time later during the investigation it was determined that a phone call was made to Randal with the subject of the conversation being victim 2. A truck driven by Michael Goff pulled in front of the residence and a passenger being identified as Randal Bledsoe exited the truck and entered the yard. Shots were fired and two children were sleeping in the residence. Michael Goff admitted he accidentally fired one round in the truck and when he exited the truck attempted to fire a round at victim 2 but the gun misfired. Randal and Michael fled the scene. Cheyanna Suddath, and Donette Hightow-

er, and Jeremy Patrick were at the residence where victim 2 was held at gun point. All parties were charged in the case. This did occur in Loudon County, Tn.

Michael Goff, 38, N Vance Street Gastonia, was charged with Attempted Murder x2, and Reckless Endan-

germent.

Randal Bledsoe, 39, Watson Chapel Road Madisonville, was charged with Attempted Murder x2, Reckless Endangerment x3.

Donette Hightower, 32, Candlerook Lane Lenoir City, was charged with Aggravated Kidnapping x6.

see Update ctd. pg. 8

**LONNIE JONES**  
**OPTICAL DISPENSARY**  
 "We Make The Difference You Can See"  
 Locally Owned and Operated

Over 1000 Frames To Choose From  
 No Frame Over \$69.00



On the corner of A & Depot Street, Lenoir City  
**986-7803**  
 Serving Loudon County for over 40 years

**LOOK! \$75 Weekly Payments LOOK!**

MARTY'S AUTO SALES • 986-2222 • MARTY'S AUTO SALES • 986-2222 • MARTY'S AUTO SALES • 986-2222 • MARTY'S AUTO SALES • 986-2222 • MARTY'S AUTO SALES • 986-2222

**Bad Credit**  
**Divorce**  
**Fixed Income**  
**Repos**  
**Bankruptcy**  
**No Credit**



# APPROVED!

Visit Us On The Web At:  
**martysautosales.net**

**NO CREDIT CHECKS**

 <b>07 Cobalt, 5spd, gas saver, runs great Only \$499 down*</b>	 <b>02 Sable, sunroof, loaded, Only \$499 down*</b>	 <b>04 Cavalier, 2dr, Sporty, Only \$499 down*</b>	 <b>01 Sebring 2dr. sporty, Only \$499 down*</b>
 <b>00 Civic, auto, Gas Saver, Only \$299 down*</b>	 <b>06 PT Cruiser, auto, gas saver Only \$399 down*</b>	 <b>04 Stratus, 4 cyl, Runs good, Only \$399 down*</b>	 <b>98 Bonneville, 6 cyl, Auto, low payments only \$99 down*</b>

**NO Credit Checks**

## Marty's Auto Sales

**986-2222** Se Habla Español

**100% Approval\***

\*See Dealer for details. All down payments plus tax, tag, title and fees.

MARTY'S AUTO SALES • 986-2222 • MARTY'S AUTO SALES • 986-2222 • MARTY'S AUTO SALES • 986-2222 • MARTY'S AUTO SALES • 986-2222 • MARTY'S AUTO SALES • 986-2222

Update ctd.. from pg. 7

Cheyanna Suddath, 23, Grey Street Memphis, was charged with Aggravated Kidnaping x6, and Violation

of Probation x3.

Jeremy Patrick, 34, Little Dogwood Kingston, was charged with Aggravated Kidnaping x6.

A Name You Already Know And Trust Just Got Even More Dependable  
**DEPENDABLE AUTO SERVICE, LUBE AND TIRES**  
is Now Offering  
**Expert, Affordable Transmission Service**

All ASE Certified Technicians

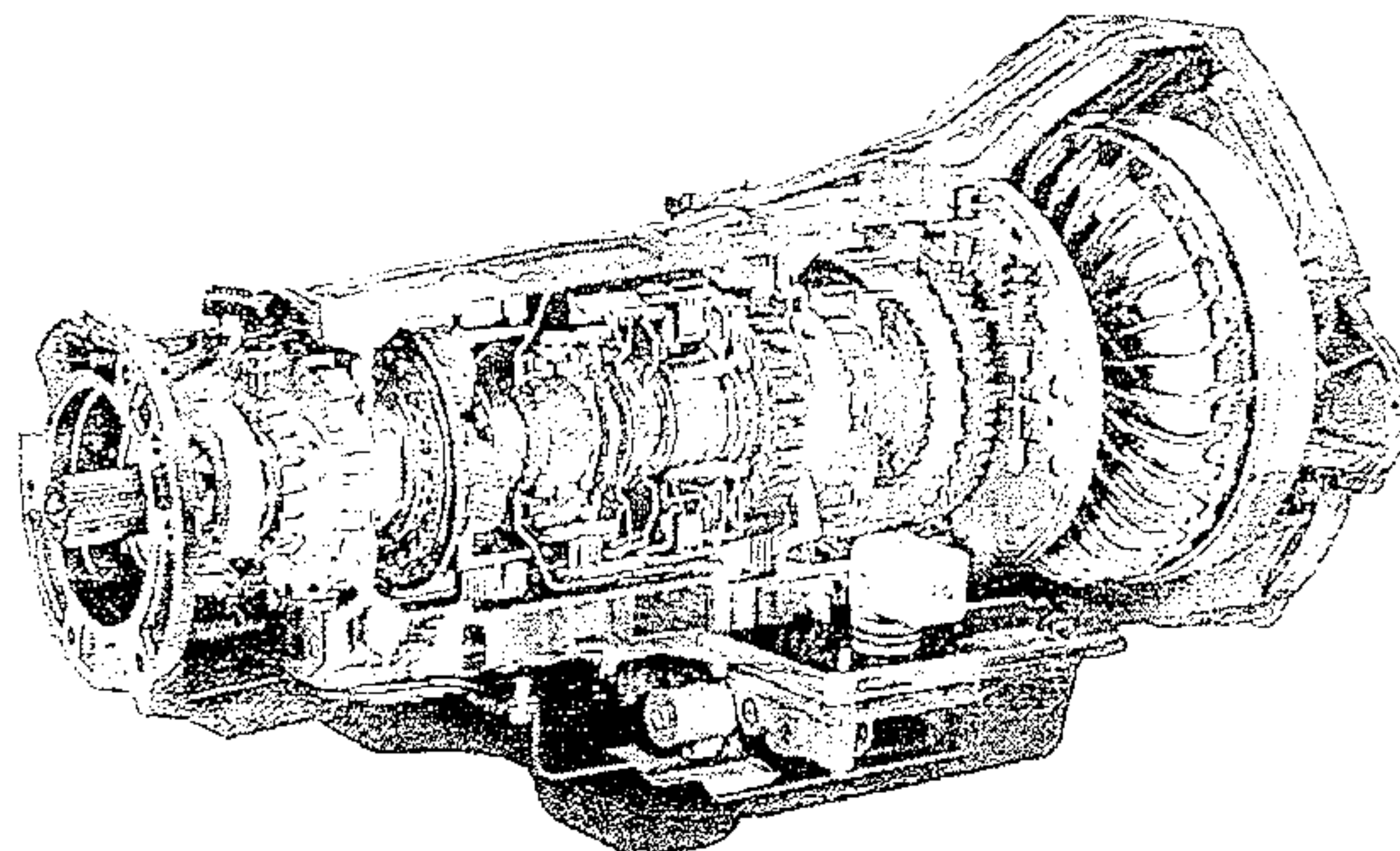

We proudly welcome all New Customers and Former Advanced Transmission Customers with a 10% Discount and Any Transmission Service or Repair\*

865-986-9359

865-986-5050

### Is Your Washer Broken?

Call Me

I Only Charge \$100 Period!!!

Call Allen

865-617-7113

**Darrell Moats**  
**Heating & Cooling**  
Sales • Service  
Installation

**986-HEAT**  
(4328)

## Bad Credit, No Credit OK!!! We Finance Everybody!!!

### Low Down Payment!!!

Over 100 Cars, Trucks & Vans in Stock - Warranties On ALL Vehicles Sold!!!

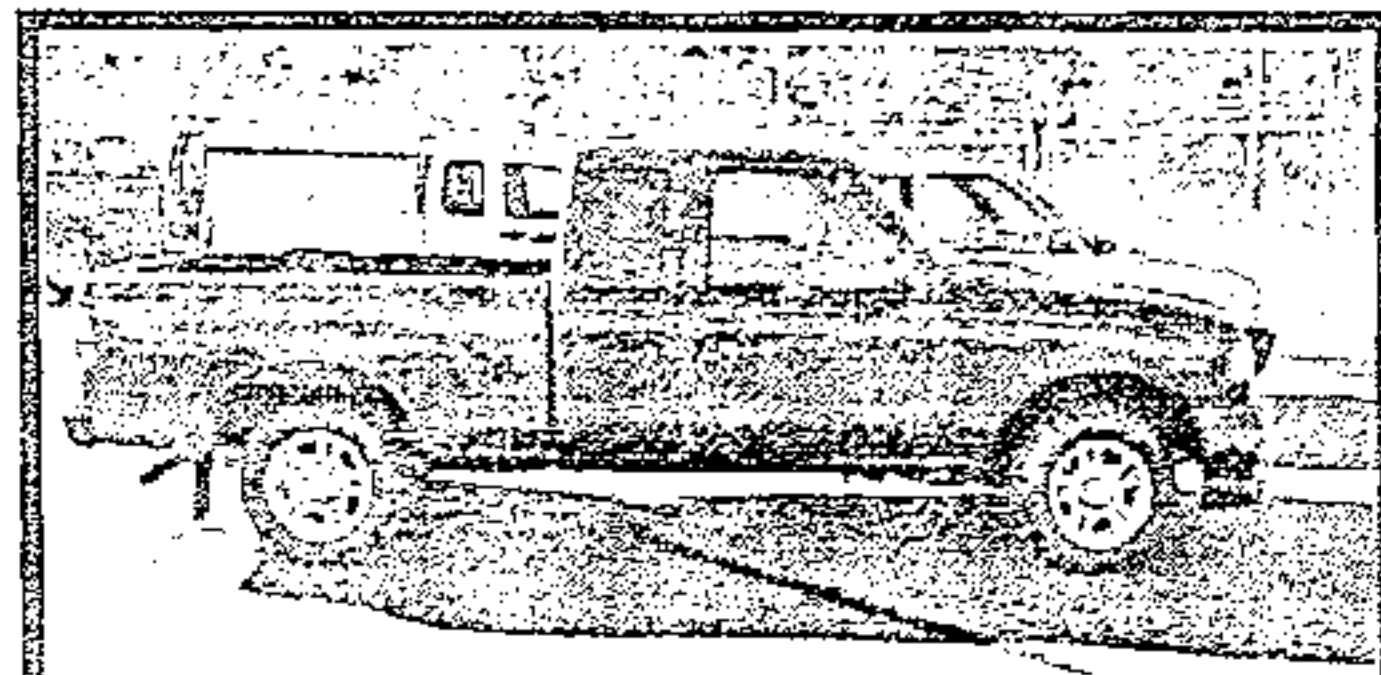

2005 Ford Ranger, Super Nice Truck, Very Low Miles

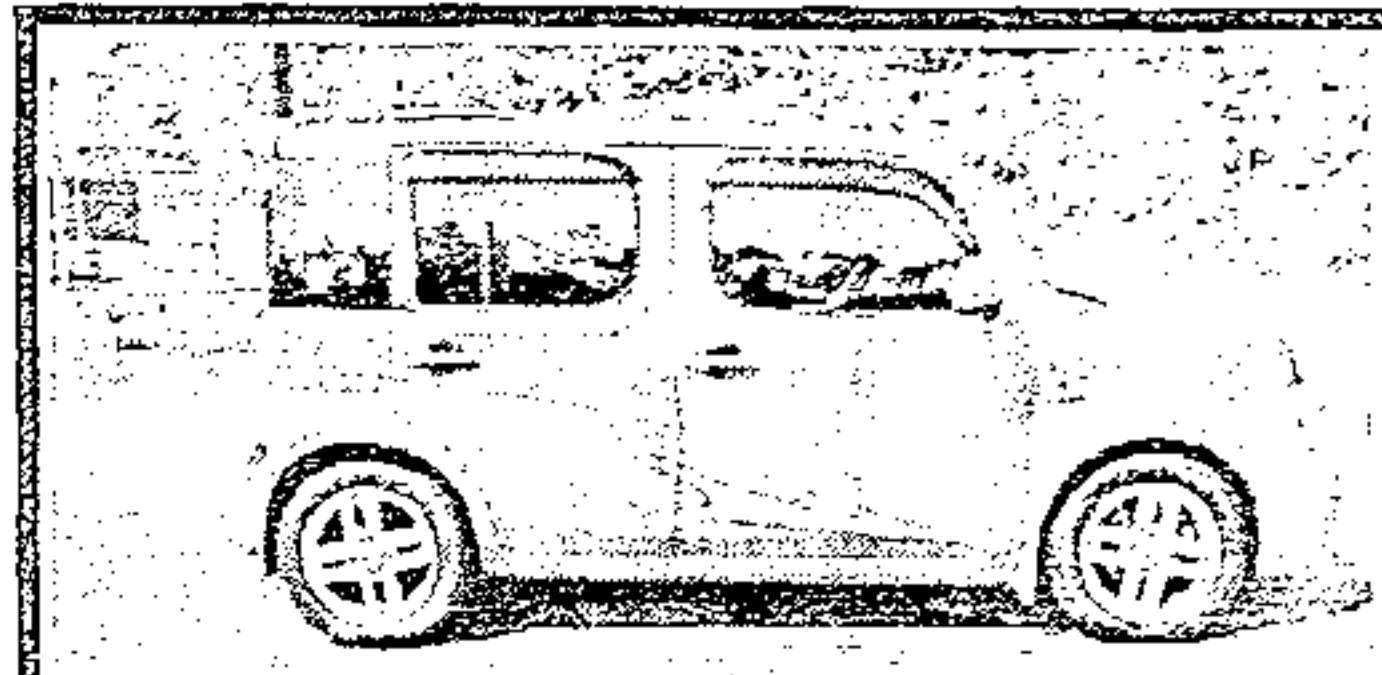

2009 Nissan Cube, Great Gas Saver, Clean

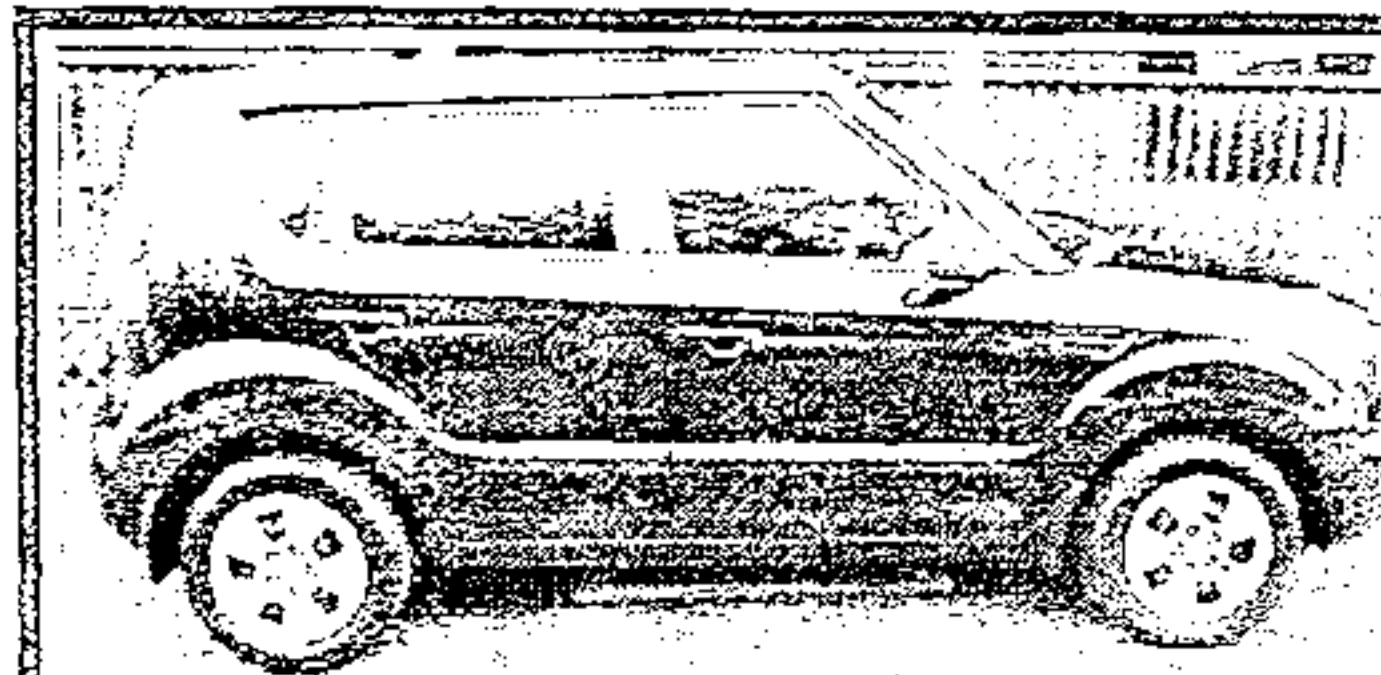

2011 Kia Soul, 5 speed, 4 dr, Gas Saver, Nice & Clean

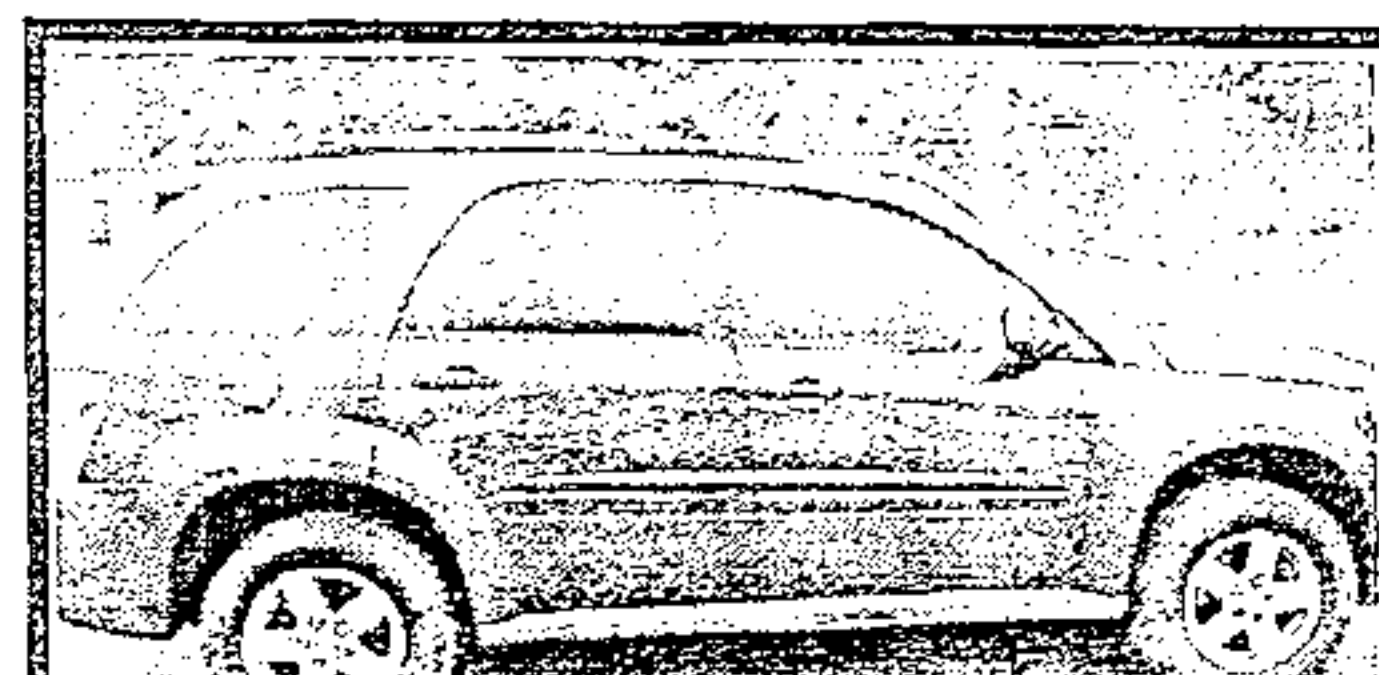

2007 Chevy Equinox, 4dr, Extra Clean, lots of room

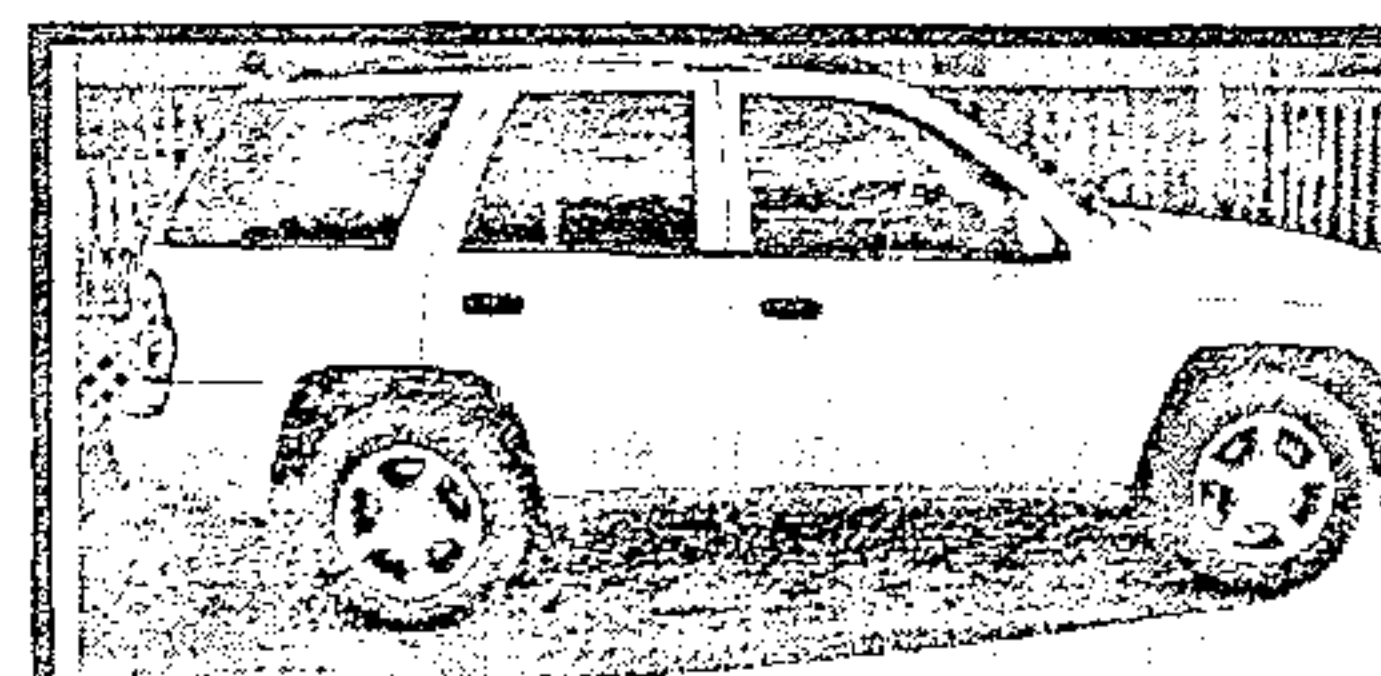

2008 Chevy Trailblazer, NICE! Loaded

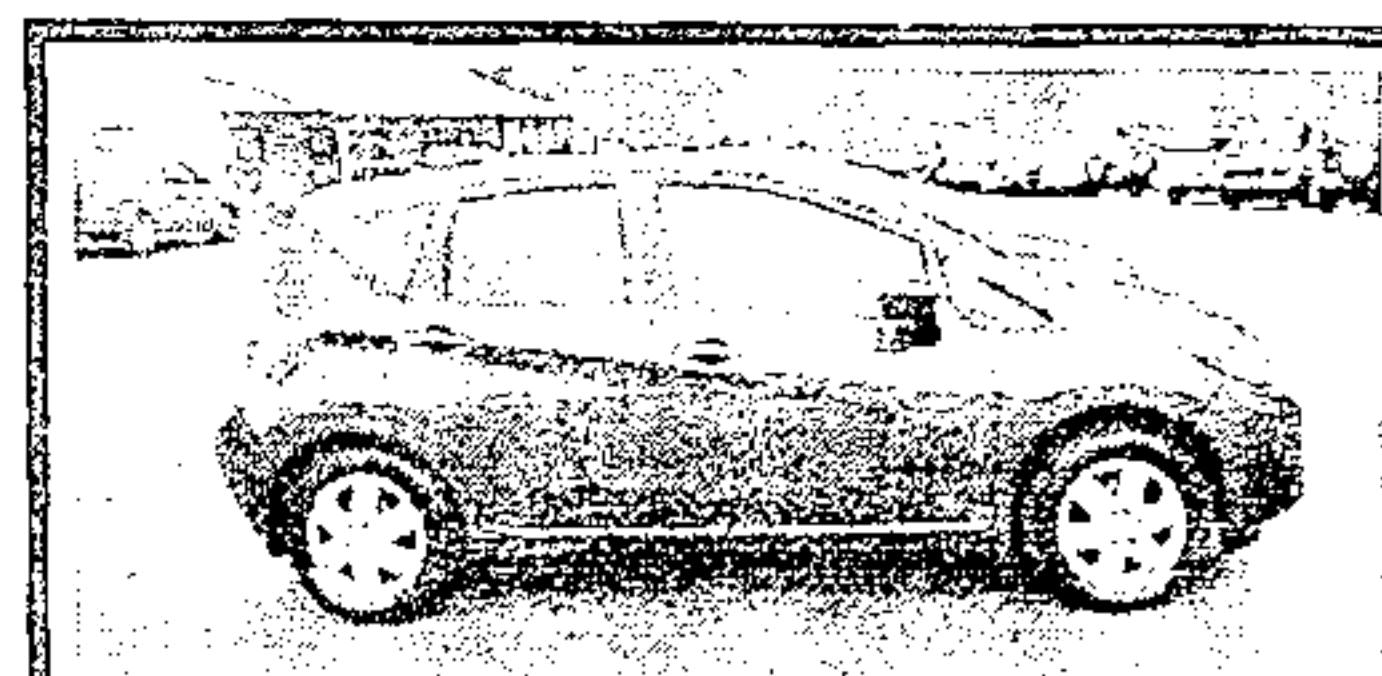

2015 Versa Note, ONLY 19k miles!, Factory Warranty!

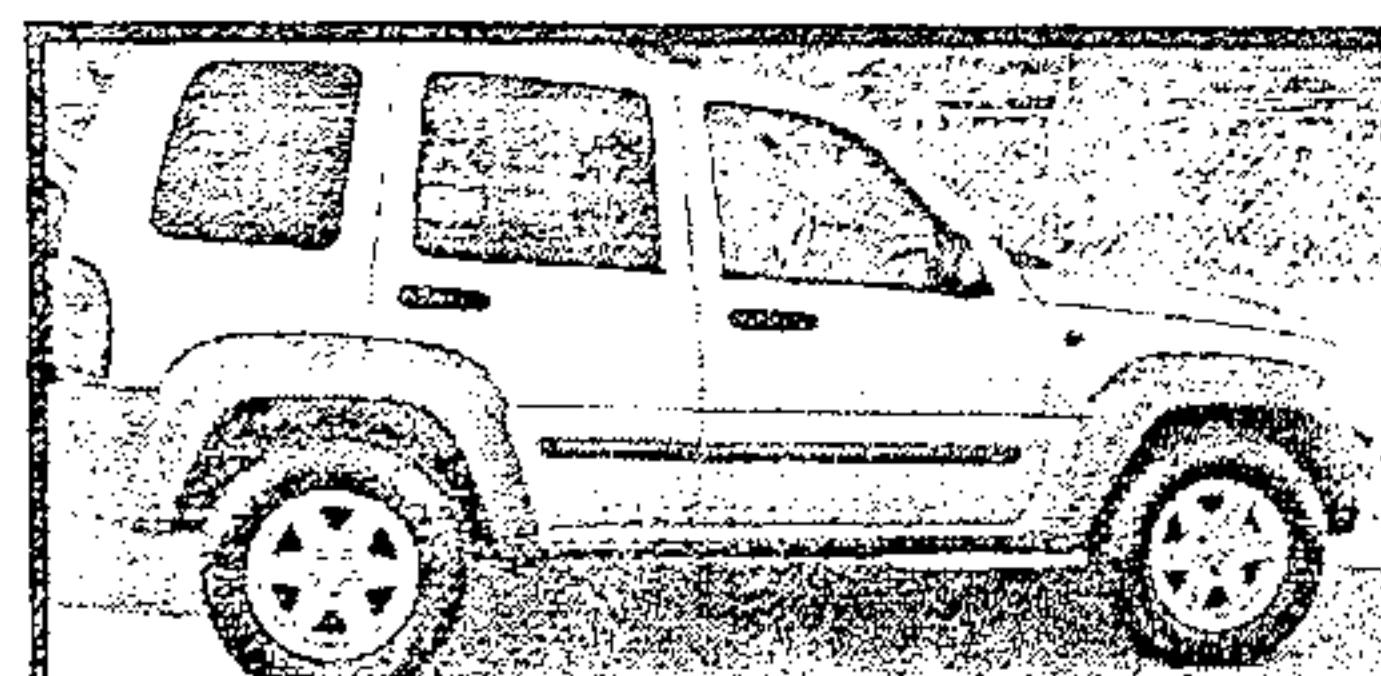

2004 Jeep Liberty, Nice, Extra Clean

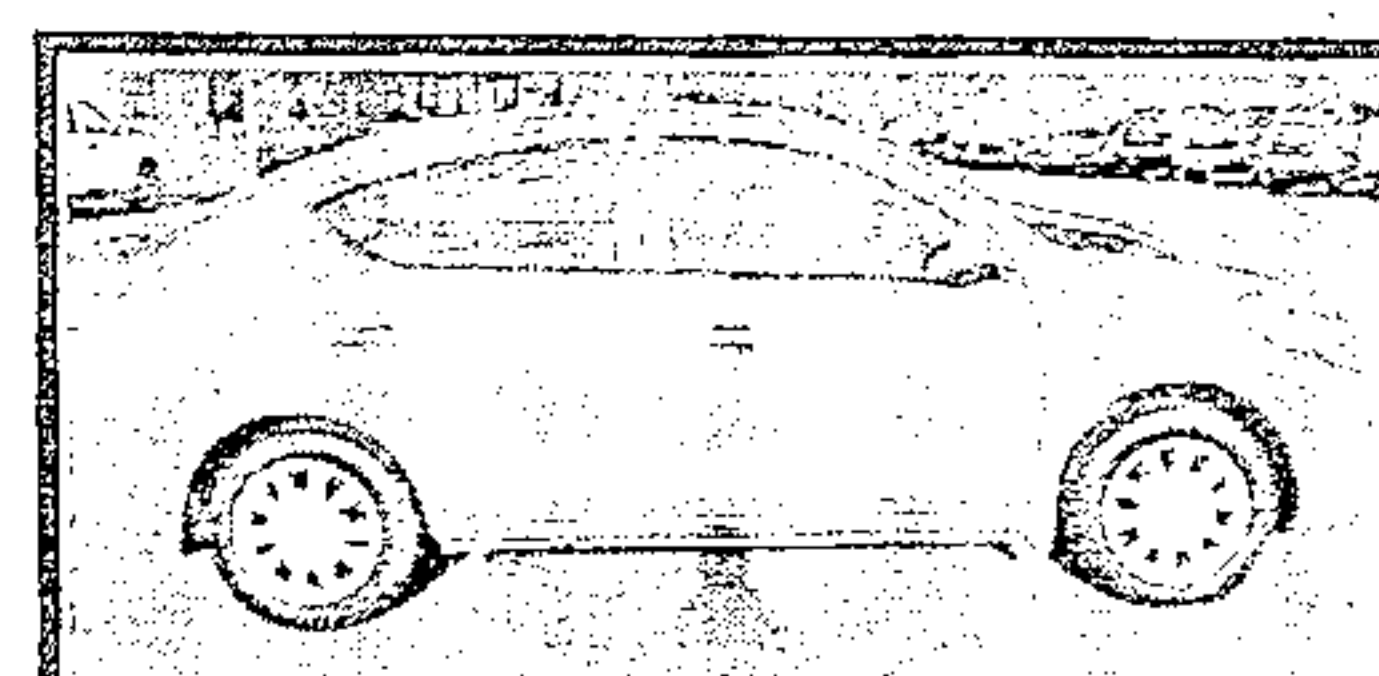

2013 Nissan Versa, Like New! LOADED!!!

## WALT WILLIAMS, INC.

\*with approved credit

3003 Highway 11

Lenoir City, TN

865-986-1111