

# The Daily Edition

50¢

Serving Loudon, Monroe and Surrounding Counties

Monday, December 14, 2015

Domestic charge follows argument



Justin Kersey  
(see DV pg. 3)

Passed out in the food court a bad idea at the truck stop



James Hunter  
(see PI pg. 2)

2 DUI's in 1 traffic stop; drivers were just talking in parking lot



Rebecca Harrison



Bradley Cagle  
(see Stop pg. 5)

Shooting call ends with drug bust of man wanted by US Marshalls

Jeremy Patrick, 34, Little Dogwood Kingston, was charged with Man/Sell/Del/Resale SchII, Contraband in Penal Institution, and Assisting other Agency. Officer Jeremy Dishner LCPD, was dispatched to assist the LCSO on shots fired call at Mountain View Road. Prior to Officer arrival dispatch advised Officer that a red mustang had left

(see bust pg. 7)

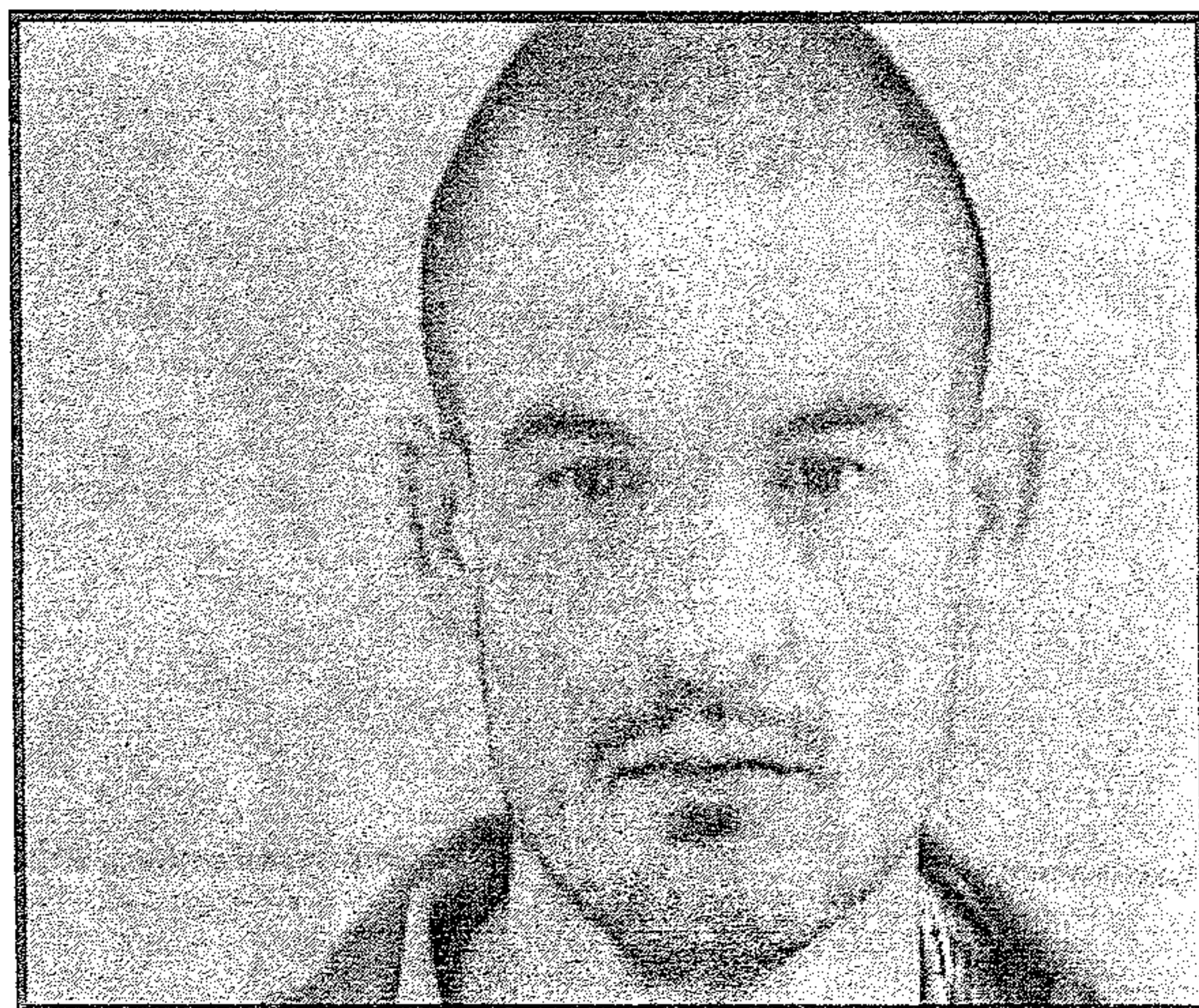

Jeremy Patrick

Haslam Announces Next Step in Drive to 55

Changing landscape in higher education prompts new discussion around alignment, focus

Tennessee Gov. Bill Haslam today announced the next step in the Drive to 55: ensuring that colleges and universities are organized, supported and empowered in efforts to increase the number of Tennesseans with a postsecondary credential to 55 percent by 2025.

To enhance student success across higher

education the plan includes key strategies to provide more focused support for community and technical colleges, increase autonomy and local control for Tennessee Board of Regents (TBR) universities and strengthen the Tennessee Higher Education Commission (THEC).

“Since the launch of the Drive to 55 we

**Verse of the Day**

Do not be yoked together with unbelievers. For what do righteousness and wickedness have in common? Or what fellowship can light

have with darkness? — 2 Corinthians 6:14

**Obituaries**

see inside

**Wazzup**

How bout them Vols landing in a bowl game this year, sure didn't see that coming after those

big losses, Go Vols!

**Weather**

Today: Thunderstorms in the morning will give way to lots of sunshine late. High 62F.

Tonight: Clear skies. Low 41F.

Tuesday Sunny. High

67F.

Tuesday Night Clear skies. Low 41F.

**Horoscopes**

Sagittarius 11/22-12/21 You're over the Moon with enthusiasm, even if you don't have any

(Continued on page 6)

(see 55 pg. 4)



PI

James Hunter, 27, Homeward Drive Weaverville, was charged with public Intoxication.

Deputy Yoakum LCSO, was dispatched to Watt Road in Loudon County in reference to a subject sleeping in a food court booth at the TA Truck Stop. Upon my ar-

rival the truck stop employee stated that the subject could not stay at the truck stop any longer due to the fact that he appeared to be intoxicated. Deputy found the subject, James Dean Hunter, asleep in a food court booth. Deputy immediately could smell an odor of alcohol coming from his person as he slept. Deputy attempted numerous

times to wake Mr. Hunter and was finally successful after announcing himself and that he was with the Loudon County Sheriffs Office. Mr. Hunter's eyes were blood-shot and he appeared to be

(see PI ctd. pg. 3)

**Notice**  
 Vin 1B7HU18Z82J104653  
 2001 Dodge Ram will be sold. If anyone has a lien on this vehicle contact: Mon-eymaker Wrecker Service 11776 Hwy 70 E, Lenoir City 37772. 865-986-5518

Notice: The Daily Edition does not knowingly accept fraudulent or misleading materials. The Daily Edition cannot guarantee the validity of offerings or statements contained herein. All liability for the contents of all advertising, and for any claims that may arise therefrom, is the responsibility of the advertiser or its agency. The Daily Edition reserves the right to reject, edit, or abbreviate any advertisement submitted. Advertising is accepted with the understanding that all liability for all copyright violations is the sole responsibility of the advertiser. Photographs, artwork and other copy submitted for publication is considered the sole property of the advertiser. The Daily Edition will make every effort but will not be liable for failure to publish and ad or for typographical and layout errors. All statements and information about highlights featured items, letters to the editor, herein are those solely given to the interviewer or writer and the Daily Edition assumes no responsibility of the accuracy or validity thereof. The Daily Edition will gladly reprint at no charge that part of an advertisement in which an error occurs provided a claim is made within 3 days of the first publication of the ad. Information contained in the Wazzup is received anonymously and the Daily Edition assumes no responsibility for information and reserves the right to edit or reject any and/or all submissions. The Daily Edition is a daily newspaper of general circulation in Loudon County defined under TCA 2-1-104(a)(13). The Daily Edition also serves Monroe, Knox, Anderson, Roane and Blount counties and serves 30,000 readers weekly. Send mail to PO Box 1240, Lenoir City TN 37771. 865-771-2249. email: dan1204us@yahoo.com  
 The Daily Edition is Loudon County's premier public interest and paid advertising paper. The Daily Edition is produced and published daily Monday through Friday and is circulated throughout Loudon County and parts of Monroe and Knox Counties. Display advertising rates \$5.00 per column inch and quantity discounts available. Call for information on upcoming promotions and events.

**HACIENDA Ayala's**  
**Mexican Restaurant**  
 Market Dr. \* Lenoir City (In Front of Food City)

**Real Authentic Mexican Food at Affordable Prices**

**BEST MARGARITA**

You've Tried The Rest  
 Now Come Have The Best!!!

We Accept ALL Competitors Coupons Outside of Mexico City!  
 986-3553

**Good Credit OK • Bad Credit OK • Bankruptcies OK • Repo OK**

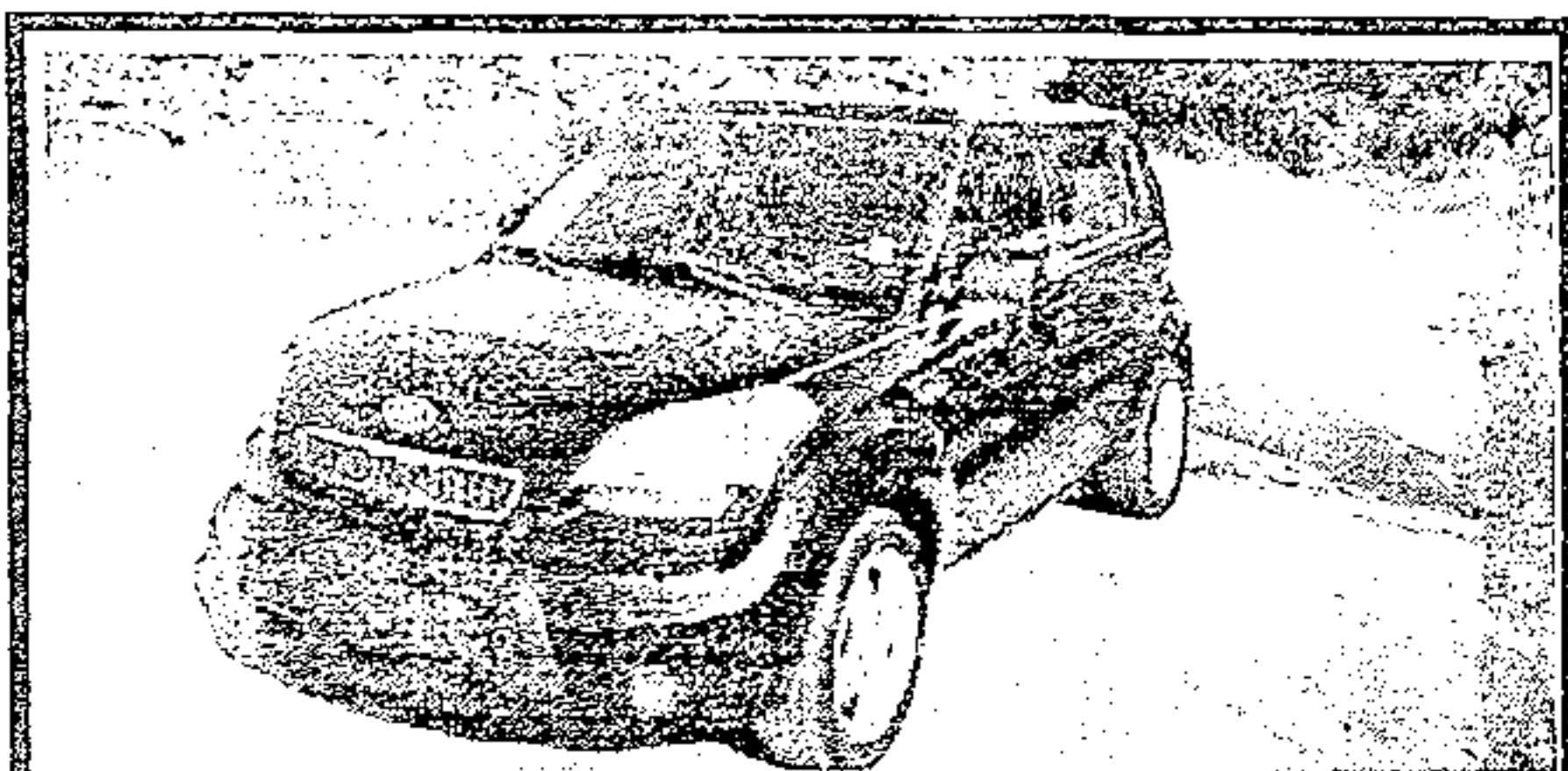

2010 Kia Soul Sporty, 4 cyl, Auto, PW, PL, A/C, Great On Gas, Like New

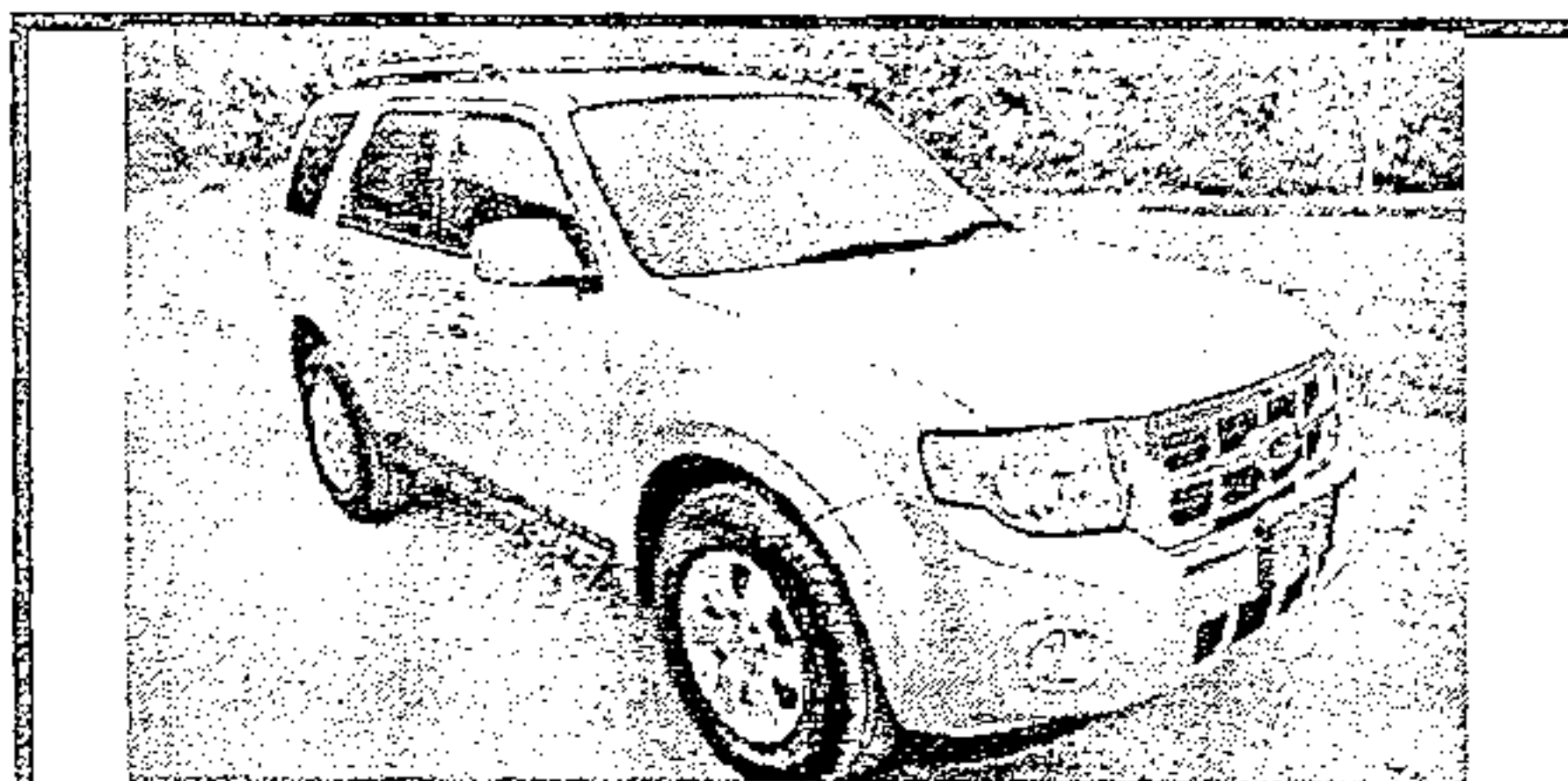

2010 Ford Escape Limited Leather, Alloy Wheels, Heat, A/C, Luggage Rack, 79K,

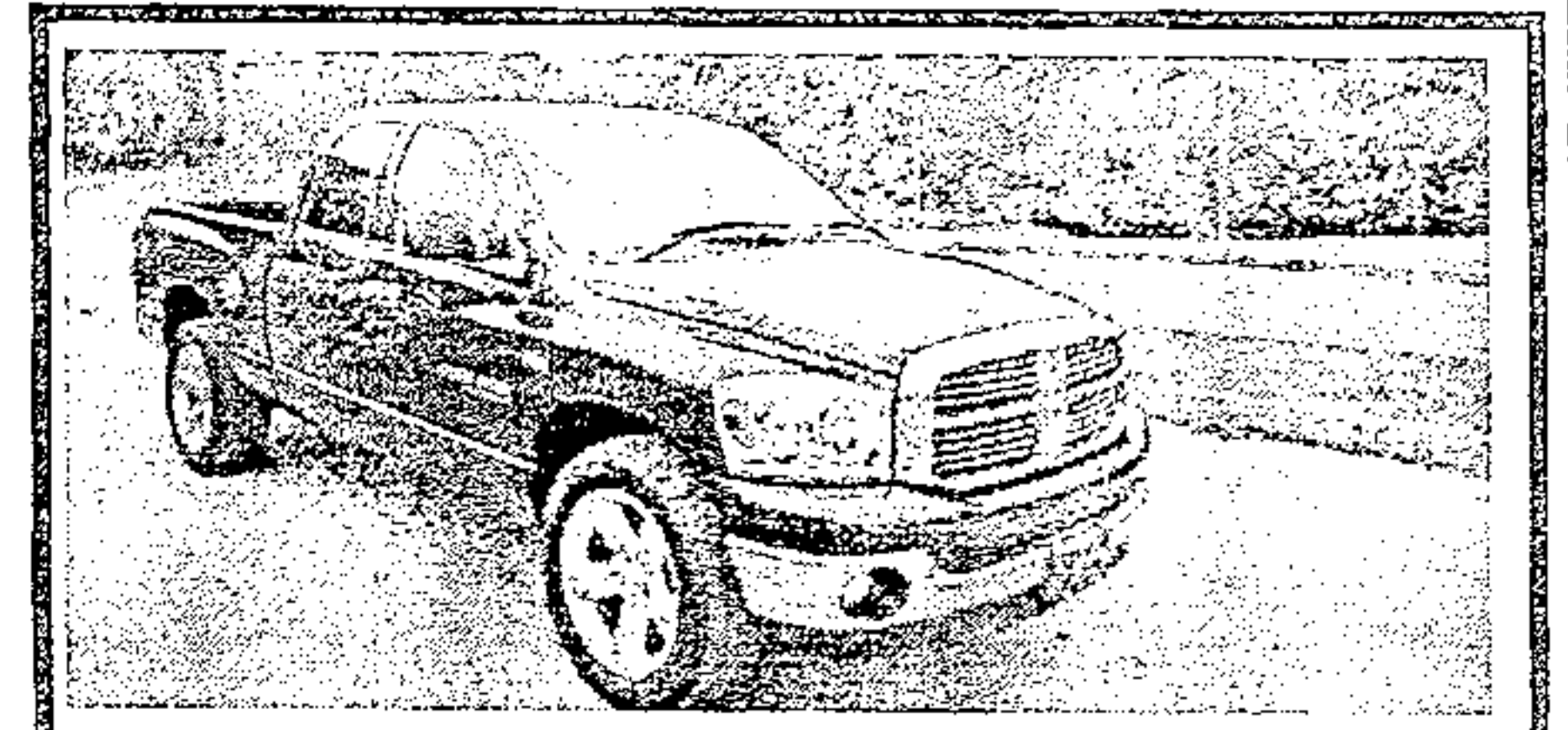

2007 Dodge Ram 1500 Quad Cab, Thunder Road PKG, 20 in. Wheels, Low Miles, Hemi

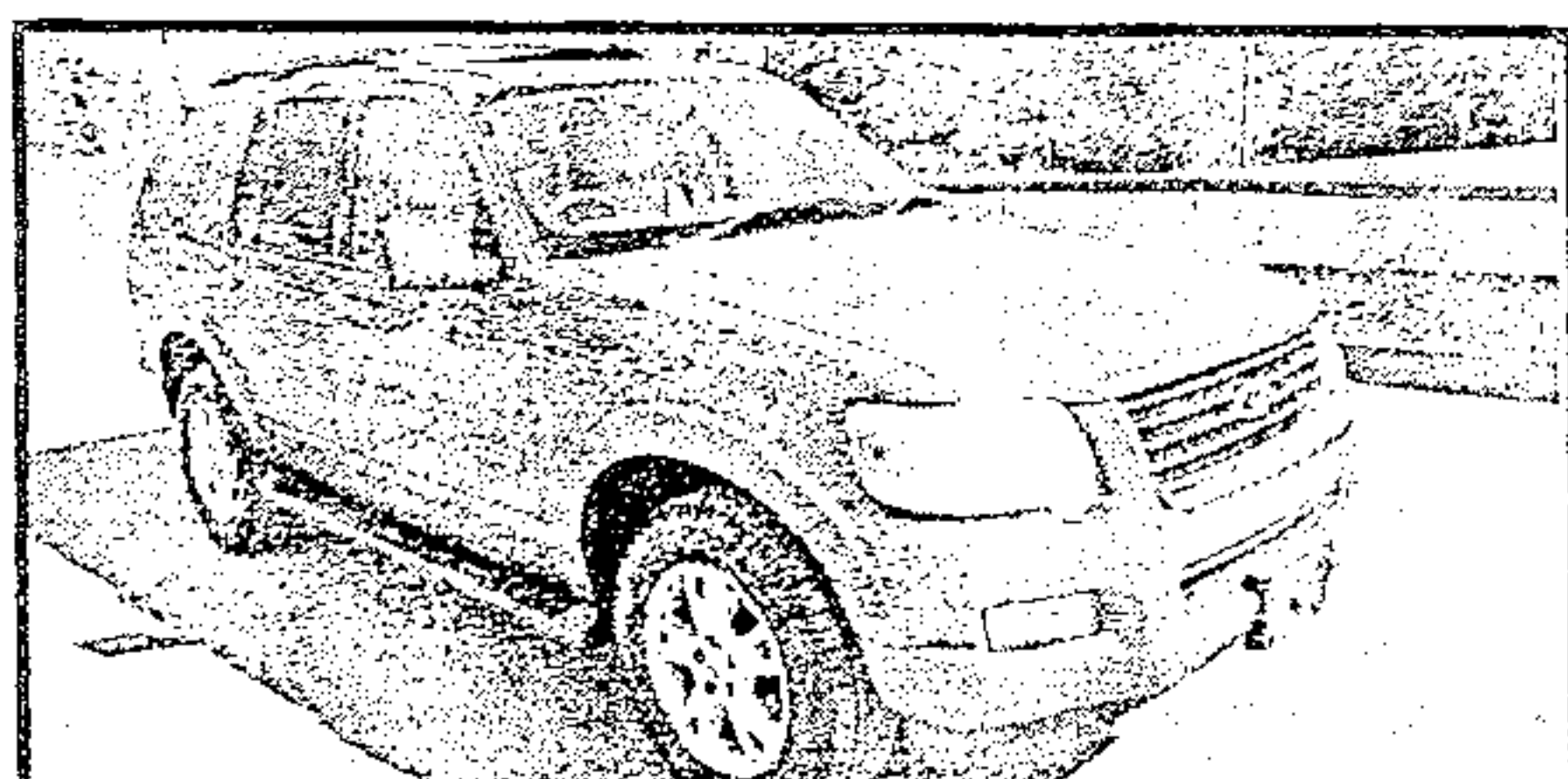

2008 Ford Explorer 84k, 3rd Row Seating, Luggage Rack, Tow Pkg, PW, PL



2011 Ford Ranger Low Miles, Tow Pkg, New Tires, A/C, Heat, Bed Liner.



2011 Dodge Grand Caravan DVD, Stow & Go, Loaded, Remote Doors, Rear A/C

**DEPENDABLE MOTORS 986-9343**  
 803 E. Broadway • Lenoir City

Serving Loudon County for 20 Years

\* WAC. See Dealer for details

Visit our website at: [www.dependablemotorslc.com](http://www.dependablemotorslc.com)

DV

Justin Kersey, 23, Jessie Lane Lenoir City, was charged with Domestic Assault.

Deputy Craig Brewer LCSO, responded to a report of a domestic dispute at Jessie Lane Lenoir City Tennessee. On arrival Deputy found victim and her husband Justin Kersey there. On talking with both subjects found that they was arguing over their relationship. Victim went upstairs with their 8 month old child into the bedroom to get away from the arguing. Justin Kersey came upstairs and forced his way into the bedroom, breaking the door. He then grabbed the 8 month old out of victims arms and kept yelling at her. This did put her in fear of being assaulted by her husband and she called the police at that time. This did happen in Loudon County Tennessee. Deputy

Craig Brewer LCSO, made the arrest.

PI ctd. from pg. 2 very confused. Deputy asked Mr. Hunter if he was okay and why he was there.

Mr. Hunter stated that he had been dropped off and he was waiting for his mother to come pick him up. Deputy made numerous attempts to find a number for someone to come and get Mr. Hunter,

but he could not provide me with a name or phone number for anyone. Mr. Hunter stated he would just leave the truck stop and begin walking. Deputy advised him he could not allow him to do that due the fact that that he appeared intoxicated and there was a strong odor of alcohol coming from his person. For his safety, and the safety of others, Deputy placed Mr.

Hunter under arrest for Public Intoxication so he would not walk away from the truck stop in an intoxicated state. All of the above occurred in Loudon County.

**The Daily Edition**

serving Loudon and surrounding counties since 1986

**For Sale: Oak Wood Mulch**



Mushroom Compost Topsoil.



Firewood

Call Steve Spoon  
**986-4282**

**West End Storage & Warehouses**  
502 Ward Avenue • Loudon  
Call 865-458-4774 or 865-679-5555

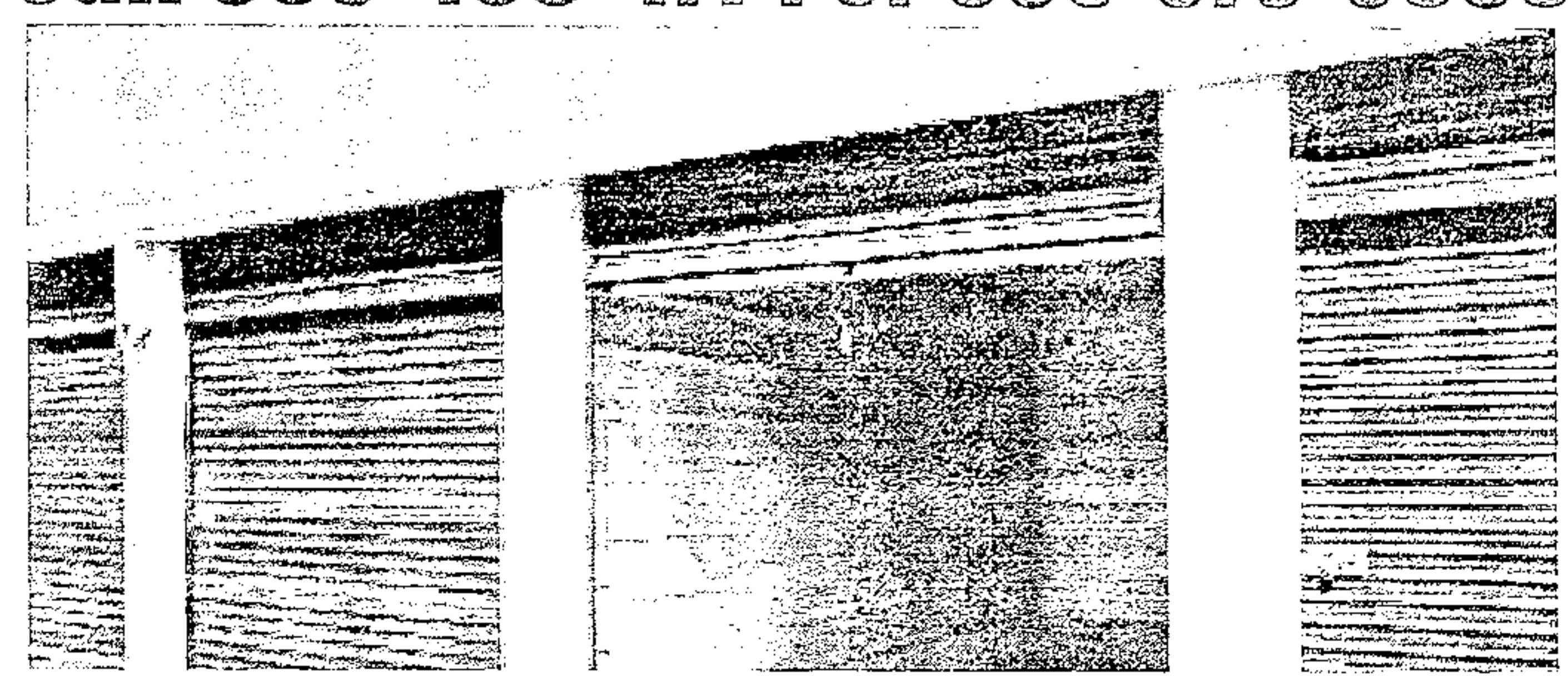

**C&C Lawn Care**  
Mowing, Mulching, Trimming, Edging, Clear Debris  
Free Estimates  
Call Chad 865-271-8070



**BIMBO'S**  
Deli Open 24 Hours  
865-986-9643 Call Ins Welcome  
Specials  
Lg. Cold Sub, bag of chips and 16 oz. fountain drink only \$6.29  
Footlong Corn Dog \$2.59

**C&J Towing and Recovery**  
LOWEST TOWING RATES AROUND!!!

Have you been overcharged for any type of towing service in the Lenoir City area? If you have a breakdown or accident please OWNER REQUEST C&J Towing with the officer. Also please call your Sheriff and ask him to place C&J Towing on the "Rotation List\*" and help other motorists save as much as you did! We at C&J are locally owned and operated, State approved, licensed, bonded and insured. Call and let us know if your denied service or how we can be of assistance.

\*note: the "Rotation List" is a list of wrecker services that provide service for wrecks, DUI's, breakdowns, etc. and are on an on-call basis for service. This list is approved by the Sheriff.

Cliff Teeters • Owner  
865-809-1661



55

have made tremendous progress, becoming No. 1 in the nation for federal student aid completion and increasing the size of our freshman class by 10 percent in one year," Haslam said. "Tennessee is at the forefront of innovation in public higher education, and the conversation has brought us to this point — making sure Tennessee colleges and universities are organized, supported and empowered to meet the demands of Drive to 55."

For the 2015-2016 school year — the first year of Tennessee Promise and Reconnect — there was a 24.7 percent increase in first-time freshmen enrollment at community colleges and

a 20 percent increase in first-time freshmen at Tennessee colleges of applied technology (TCATs).

Joined by Lt. Gov. Ron Ramsey, House Speaker Beth Harwell, Senate Majority Leader Mark Norris, House Majority Leader Gerald McCormick and higher education leaders, Haslam said the

state is developing legislation to bring during the coming session called the "Focus On College and University Success (FOCUS) Act."

Several features will include:

A sharpened focus by TBR on the state's 13 community and 27 technical colleges;

Creation of local

boards for Austin Peay State University, East Tennessee State University, Middle Tennessee State University, Tennessee State University, Tennessee Technological University and the University of Memphis;

Enhancing the role of THEC to provide greater coordination across the state, to include capital project management, institutional mission approval and higher education finance strategy;

And creation of a transition task force consisting of higher education, business, and community leaders from around the state that will serve as the administrative and advisory body throughout the transition.

Currently TBR oversees 46 colleges and universities ranging

from technical colleges to medical and law schools. Under Haslam's proposal, TBR would have a concentrated focus on the state's 13 community colleges and 27 TCATs, as other elements of the plan free up TBR to give more attention to enrollment and student success challenges that have emerged while trying to increase the number of Tennesseans pursuing credentials in higher education.

The six state universities under TBR would have increased autonomy by transitioning from sole TBR oversight to a new model that would include a local governing board. These boards would appoint the campus president, manage the university budget and

(see 55 ctd. pg. 5)

**SARCO Enterprises Inc. Offers Complete Home and Commercial Remolding and Repairs**

Our Team members have a combined total of over 40 years experience in all areas of home construction, facilities maintenance and commercial construction. Roofing, Electrical, Bath and Kitchen Renovations, we do it all with just one call. We are fully insured and our work is guaranteed.

Call us today for a free no obligation quote for your next project.  
865-809-9492.

**BUDGET**  
*Transmissions*

**Why Buy From Budget?**

Free Towing From Lenoir City or Loudon County

20 Years of BBB Zero Customer Complaints Award Member  
A+ Plus Rated

Huge Transmission Inventory  
Best Technicians Period!!!

Call (865) 584-4391 Today!

**302 S. Northshore Drive Knoxville**

**(865) 584-4391**

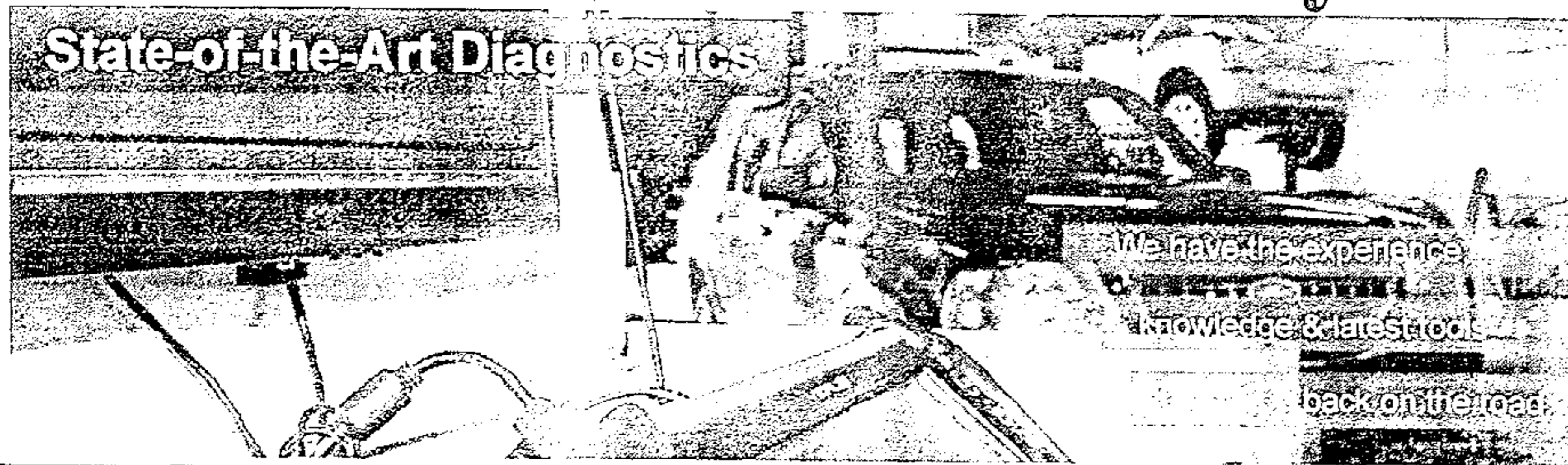
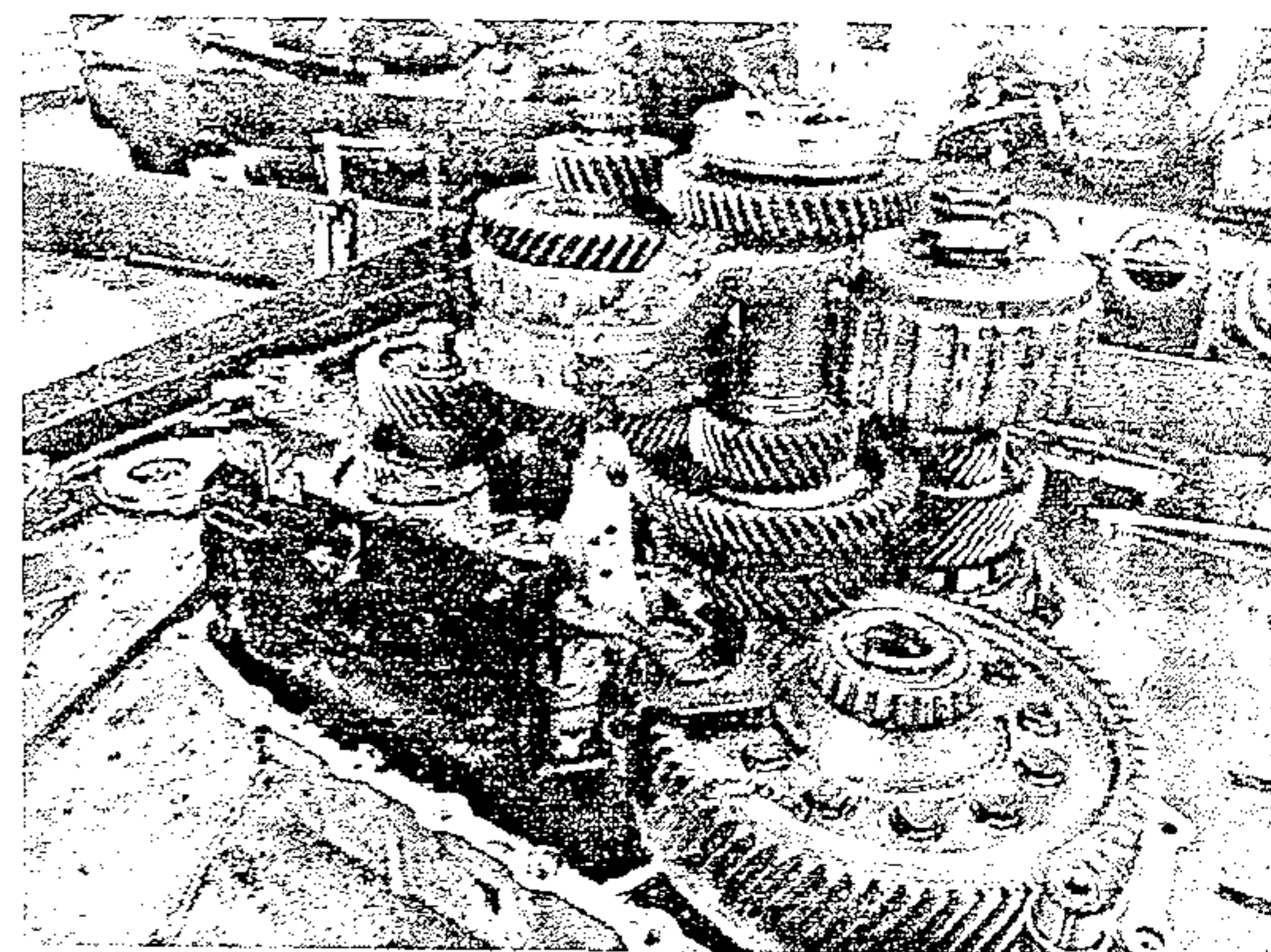

[budget-transmissions.com](http://budget-transmissions.com)

Approved Auto Repair



**Stop**

Bradley Cagle, 27, Fairlane Circle Sweetwater, was charged with DUI, and Poss. of a Handgun While Under the Influence.

Rebecca Harrison, 24, Harrison Road Loudon, was charged with DUI.

Deputy Charles Huskin LCSO, was on routine patrol, and observed 2 vehicles

sitting in the Sunoco at 19997 West Lee Highway with a white female sitting in the drivers seat an SUV, and as Deputy pulled up on the 2 vehicles a white male sit in the drivers seat of the 2nd vehicle with a black pistol in the drivers door panel in a holster, in a White Ford F-150. Deputy ask the 2 subjects's what they were doing, and they

stated that they coming from Buffalo Wild Wings, and Deputy ask them if they had been drinking. The male Mr. Bradley Cagle stated that he had 4-5 beer's and a shot of liquor. The female Ms. Rebecca Harrison stated that she had 1 beer. Ms. Harrison had a strong oder of an alcohol beverage about her person. Both Mr. Cagle, Ms. Harrison were ask to do standardizedfield

sobriety where they both performed poorly. Implied consent was read to both subject's. Ms. Harrison was advised that she was under arrest for DUI, and escorted to the Loudon County Jail for a blood alcohol breath test, and Mr Cagle was advised that he was under arrest for DUI and escorted to Ft. Loudon E.R. for a BAC. Both vehicles were left at the scene. A stolen report was ran

on the fire arm, and did come back negative 29's. This did happen in Loudon County. Deputy Charles Huskin LCSO, made the arrest.

55 ctd. from pg. 4

set tuition, and oversee other operational tasks. TBR would continue to provide key administrative support to the six state universities.

The Tennessee Higher Education Commission would assume an enhanced coordinating role in higher education, ensuring progress on a cohesive, statewide master plan for higher education; maintaining academic program quality; formulate a strategic finance plan for state higher education that incorporates tuition, capital and funding formula components and setting binding tuition and capital recommendations.

"Tennessee's future in economic development will depend on us having a workforce that is ready for high skill, high wage jobs, and as part of that effort we have to make sure our colleges and universities are strategically aligned in supporting student suc-

(see 55 conc.. pg. 8)

**PURDY'S AUTO PARTS AND SALVAGE**  
**WE BUY SCRAP IRON • COPPER • BRASS • ALUMINUM**

**\$** **Paying Top \$\$\$**  
**Call For Latest Prices**

*You Name It, We Buy It!*

*Radiators, Wheels, Batteries, Appliances, Farm Equipment*

**Copper**  
**Paying Top \$\$\$**  
**Call For Latest Prices**

**Complete Cars**  
**per 100 lbs.**

**Scrap Metal**  
**Paying Top \$\$\$**  
**Call For Latest Prices**  
**per 100 lb**

**We Buy Batteries**

**Aluminum Cans**  
**Paying Top \$\$\$**  
**Call For Latest Prices**

**You Call We Haul!**  
**423-519-5402**

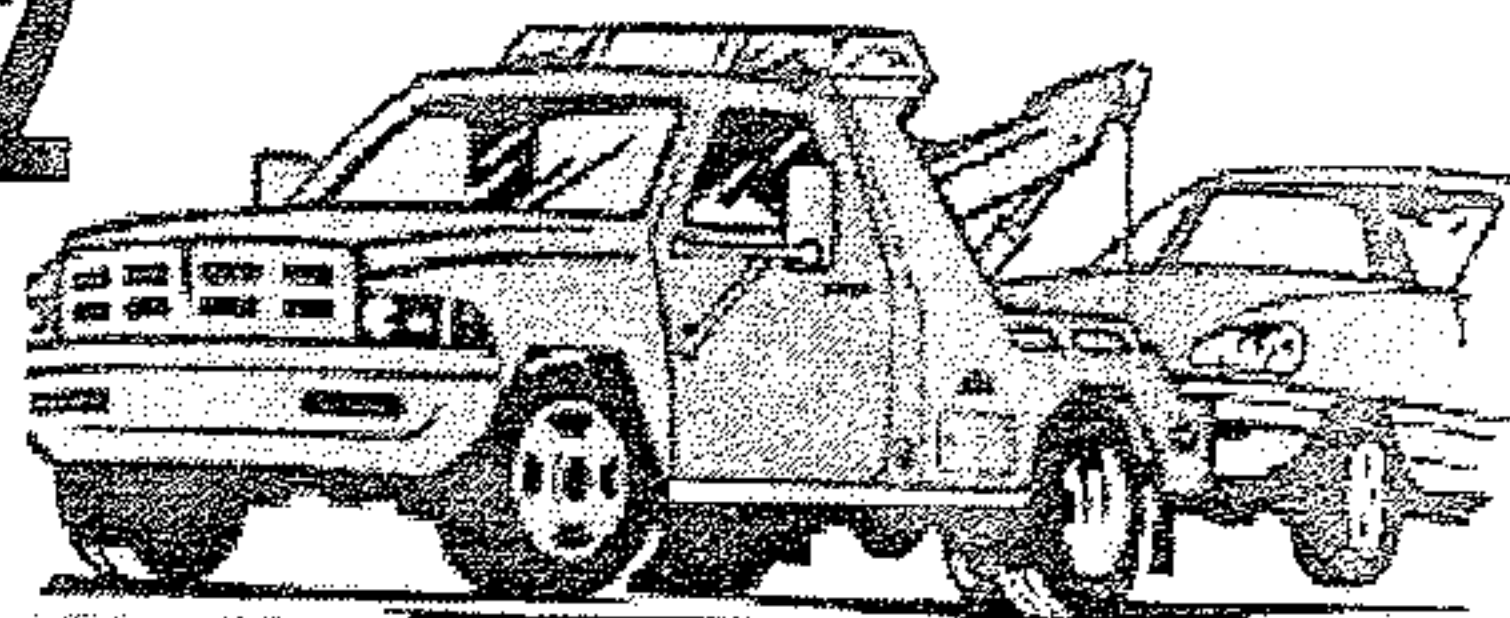

**Now Selling**  
**Aftermarket**  
**Body Parts at**  
**Discount Prices**

Prices subject to change with the market.

**423 337-3977**  
**149 County Road 323 Sweetwater**

Prices subject to change with the market.

**Wanted**  
 Looking for a person interested in covering events in and around Loudon County. Must have license, own transportation, a computer or equivalent and can write.  
 Call Dan at 771-2249 to set up an interview.

**bust**

the residence traveling toward the Lenoir City High School. Officer Keith Sennett stopped the vehicle in the High School parking lot and detained the driver Jeremy Patrick as a suspect in the shooting call. Jeremy was placed under arrest for outstanding warrant issued by the US Marshall Service.

After reaching the jail, a search was conducted by Deputy Jon Carter LCSO, during the search a baggie containing a Crystal like substance believed to be Methamphetamine.

Officer Jeremy Dishner LCPD, made the arrest.

**Police beat**

Vickie Skidmore, 54, 2nd Ave Lenoir City, was charged with Failure to Appear.

Deputy Brandon Dishner LCSO, served a FTA Warrant on Vickie at the Loudon Jail.

Matthew Stevens, 55, Toqua Club Way Loudon, was charged with Failure to Appear. Deputy JC Schultz LCSO, arrested Matthew on a FTA Warrant and transported to Loudon Jail.

Larry Davis, 28, Kelly Lane Lenoir City,

was charged with Contempt of Court. Officer Brandon Johnson LCPD, arrested Larry on a Contempt Warrant and transported him to the Loudon Jail.

Ciara Winckler, 26, Browder Hollow Road Lenoir City, was charged with Failure to

Appear. Deputy Chris Bowen LCSO, arrested Ciara on a FTA Warrant and transported to Loudon Jail.

**WANT TO BUY TRACTS OF TIMBER**  
Call 423-371-0999

**Darrell Moats**  
**Heating & Cooling**  
**Sales • Service**  
**Installation**  
**986-HEAT**  
**(4328)**

**LONNIE JONES**  
**OPTICAL DISPENSARY**  
"We Make The Difference You Can See"  
Locally Owned and Operated

Over 1000 Frames To Choose From  
No Frame Over \$69.00



On the corner of A & Depot Street, Lenoir City  
**986-7803**  
Serving Loudon County for over 40 years

**LOOK! \$75 Weekly Payments LOOK!**

MARTY'S AUTO SALES • 986-2222 • MARTY'S AUTO SALES • 986-2222 • MARTY'S AUTO SALES • 986-2222 • MARTY'S AUTO SALES • 986-2222 • MARTY'S AUTO SALES •

**Bad Credit**  
**Divorce**  
**Fixed Income**  
**Repos**  
**Bankruptcy**  
**No Credit**

**APPROVED!**

Visit Us On The Web At:  
**martysautosales.net**

**NO CREDIT CHECKS**

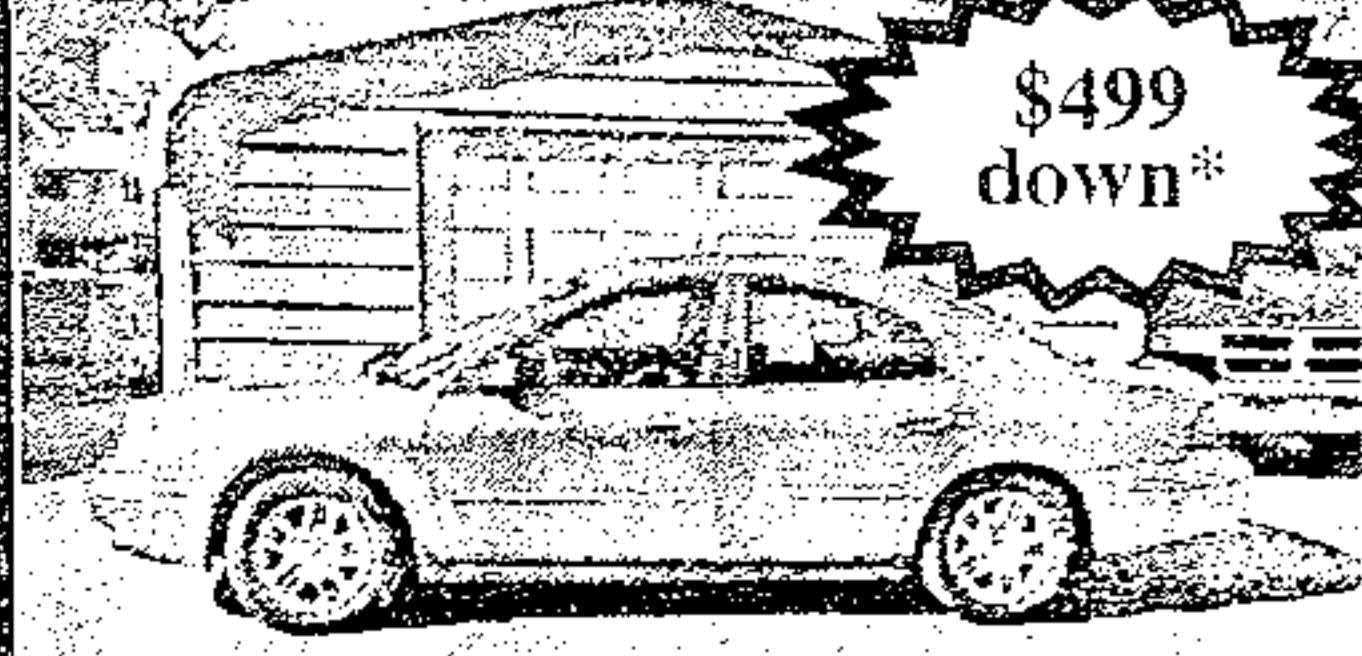
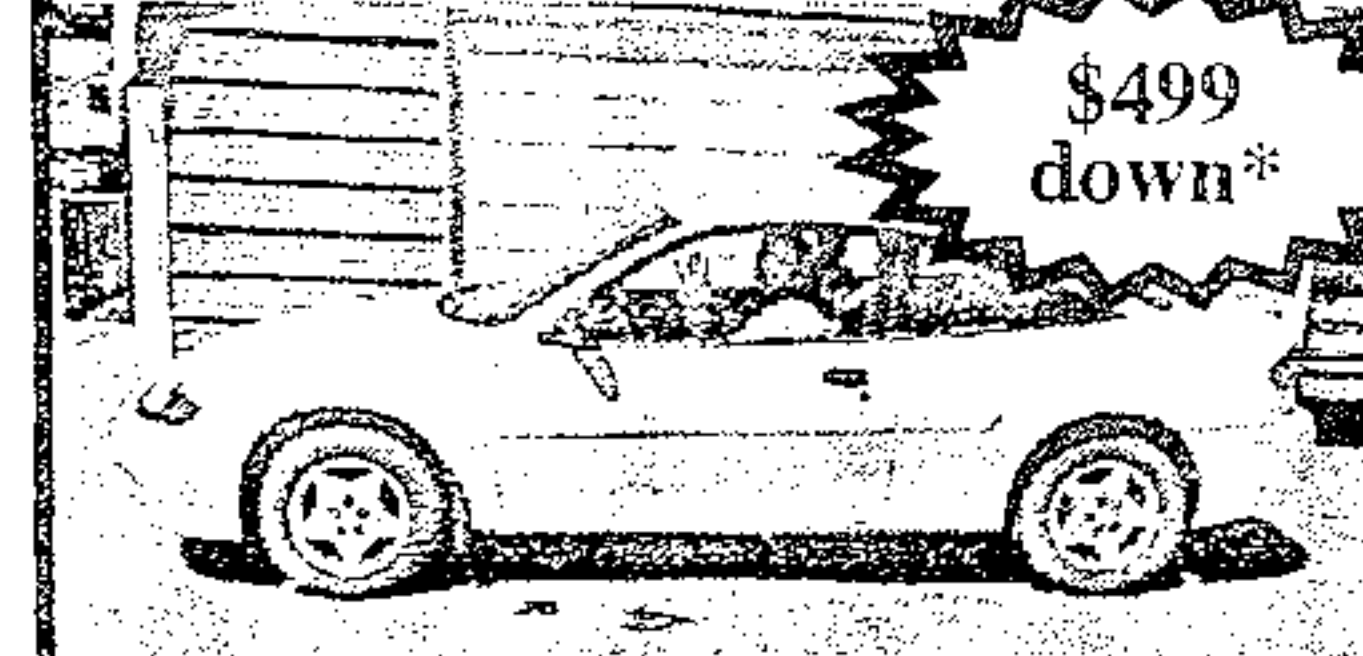
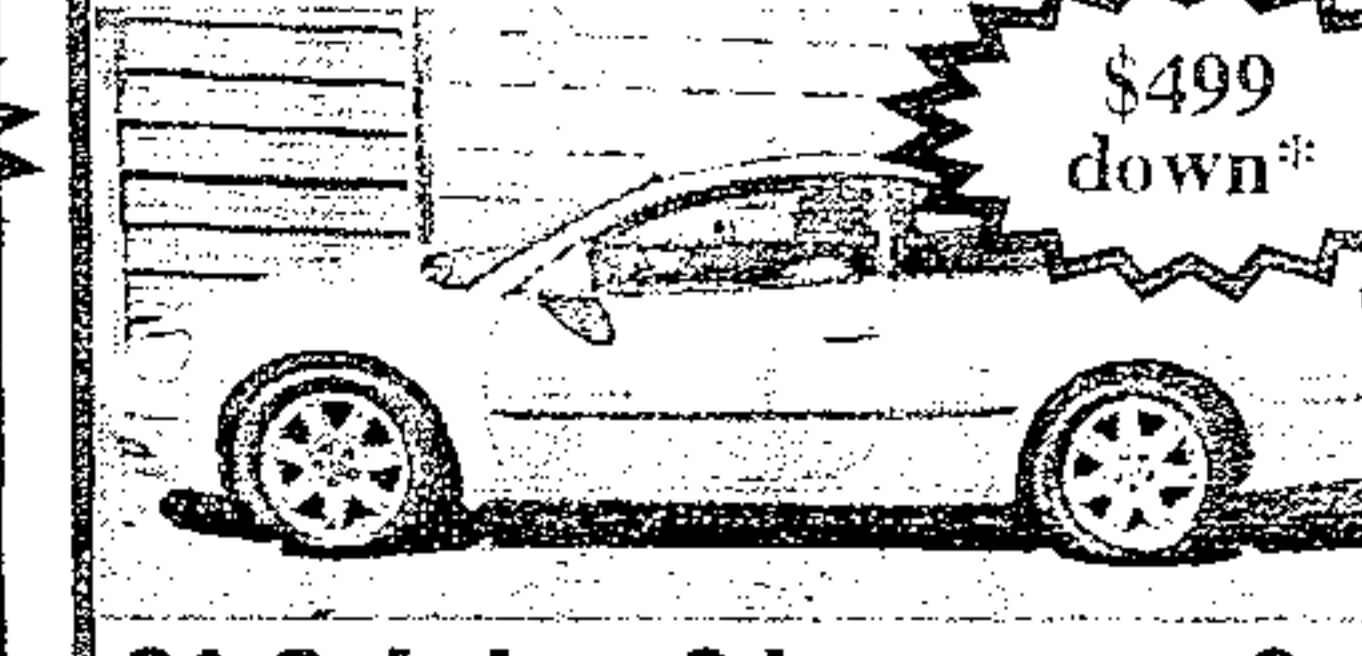
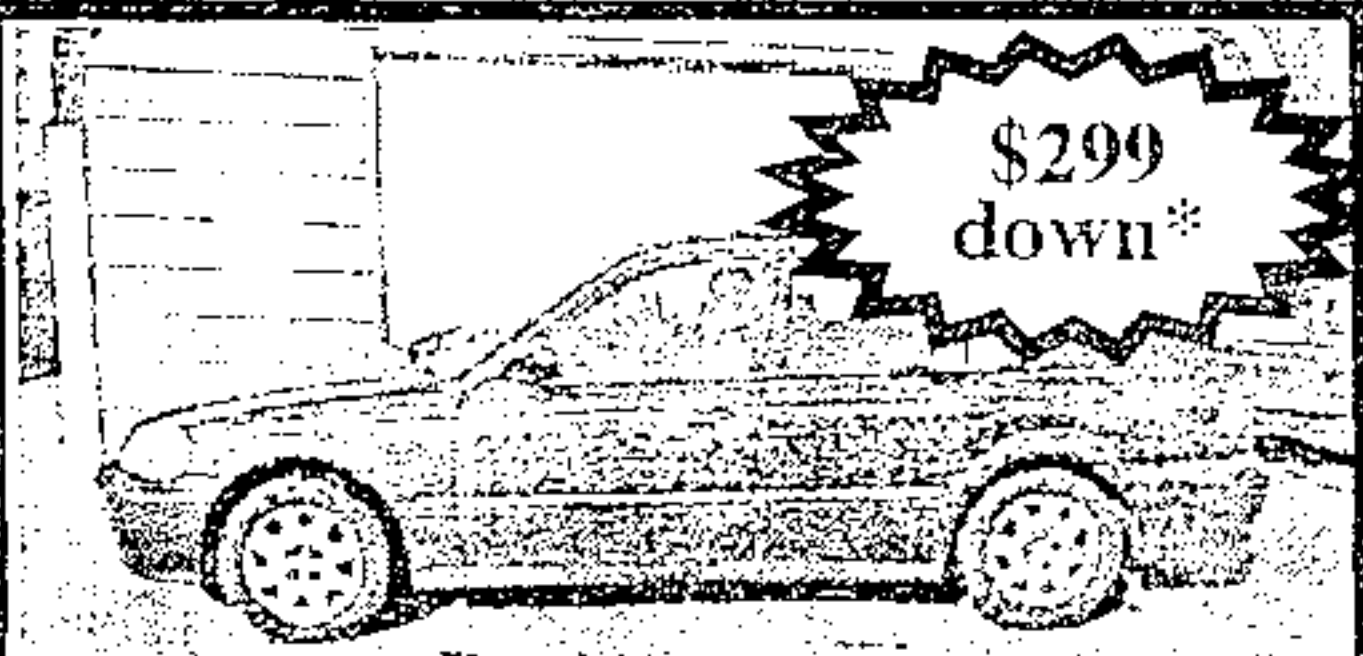
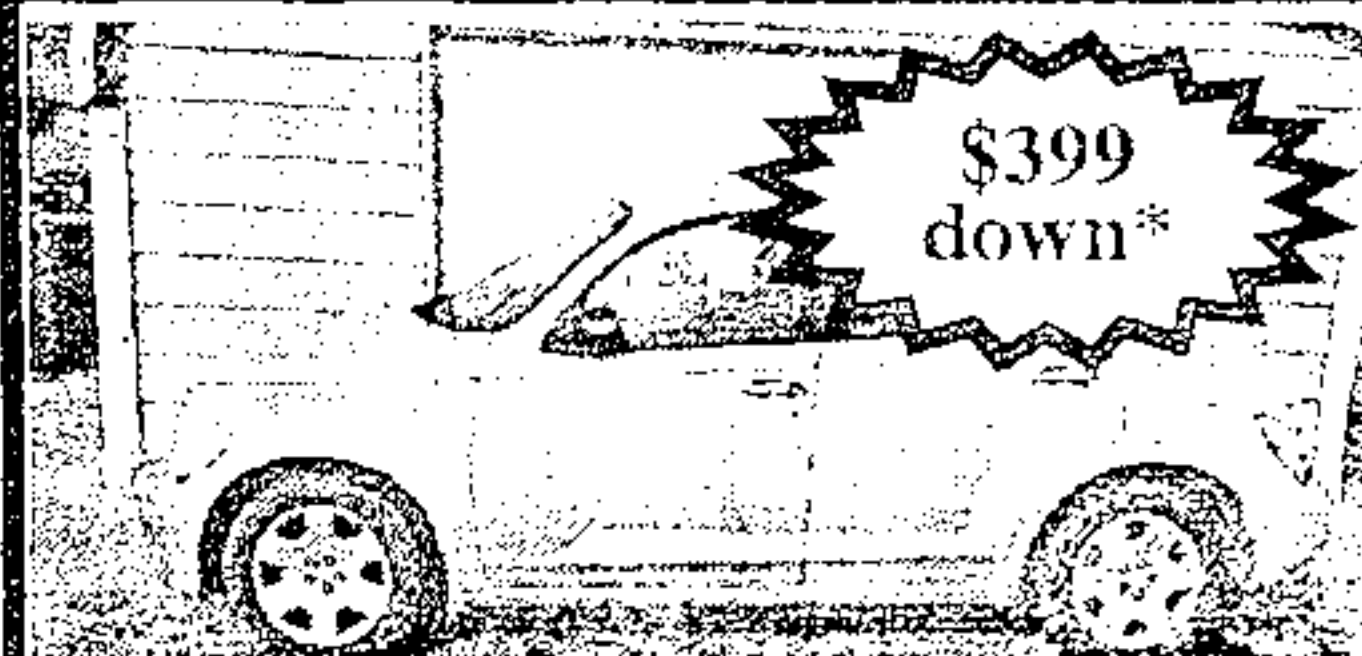
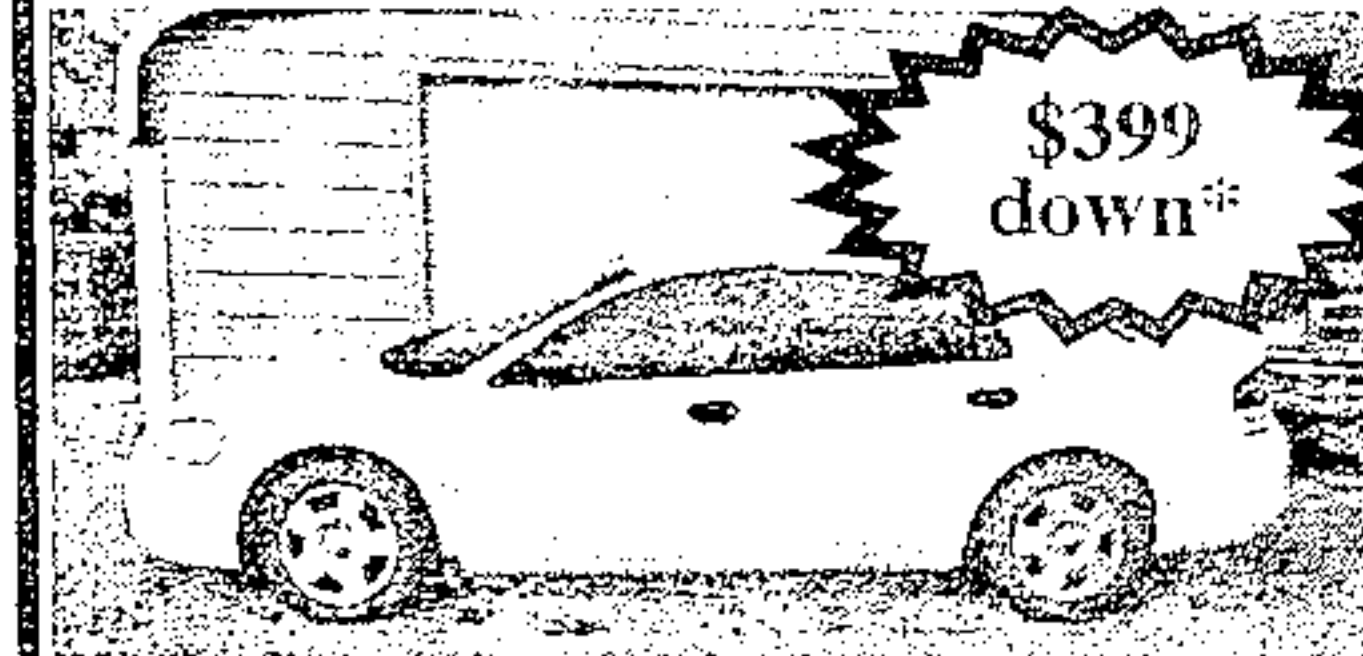
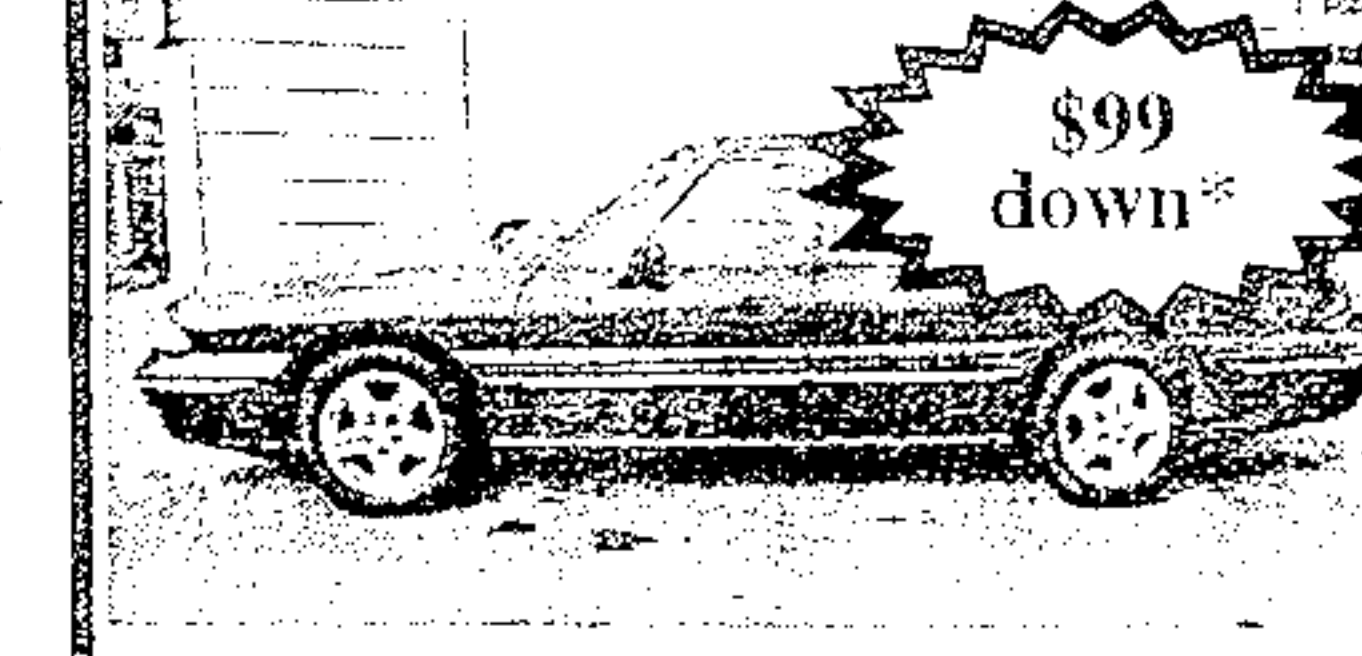
 <p><b>\$499 down*</b></p> <p><b>07 Cobalt, 5spd, gas saver, runs great Only \$499 down*</b></p>	 <p><b>\$499 down*</b></p> <p><b>02 Sable, sunroof, loaded, Only \$499 down*</b></p>	 <p><b>\$499 down*</b></p> <p><b>04 Cavalier, 2dr, Sporty, Only \$499 down*</b></p>	 <p><b>\$499 down*</b></p> <p><b>01 Sebring 2dr. sporty, Only \$499 down*</b></p>
 <p><b>\$299 down*</b></p> <p><b>00 Civic, auto, Gas Saver, Only \$299 down*</b></p>	 <p><b>\$399 down*</b></p> <p><b>06 PT Cruiser, auto, gas saver, Only \$399 down*</b></p>	 <p><b>\$399 down*</b></p> <p><b>04 Stratus, 4 cyl, Runs good, Only \$399 down*</b></p>	 <p><b>\$99 down*</b></p> <p><b>98 Bonneville, 6 cyl, Auto, low payments only \$99 down*</b></p>

**NO Credit Checks**

**Marty's Auto Sales**  
**986-2222** Se Habla Espanol

**100% Approval\***

\*See Dealer for details. All down payments plus tax, tag, title and fees.

MARTY'S AUTO SALES • 986-2222 • MARTY'S AUTO SALES • 986-2222 • MARTY'S AUTO SALES • 986-2222 • MARTY'S AUTO SALES • 986-2222 • MARTY'S AUTO SALES •

55 conc., from pg. 5

Police beat

cess," Haslam said. "The FOCUS Act will put us on that path."

By 2025, 55 percent of the jobs available in Tennessee will require a postsecondary credential, and currently only 33 percent of Tennesseans qualify. The governor launched his Drive to 55 two years ago to increase the number of Tennesseans with a postsecondary degree or certificate.

See more at: <https://www.tn.gov/news/20871#sthash.wnrQmV3X.dpuf>

Todd Edwards, 43, Dotson Branch Road Cookeville, was charged with Violation of Probation. Deputy Zack Frye LCSO, arrested Todd on a VOP Warrant at the Putman Co Jail and transported him to Loudon Jail.

Mistie Cofer, 25, Winton Chapel Road Rockwood, was charged with Failure to Appear. Cpl. David Bearden LCSO, served a FTA Warrant on Mistie at the Loudon Co. Jail.

A Name You Already Know And Trust Just Got Even More Dependable  
**DEPENDABLE AUTO SERVICE, LUBE AND TIRES**  
**is Now Offering**  
**Expert, Affordable Transmission Service**  
 All ASE Certified Technicians

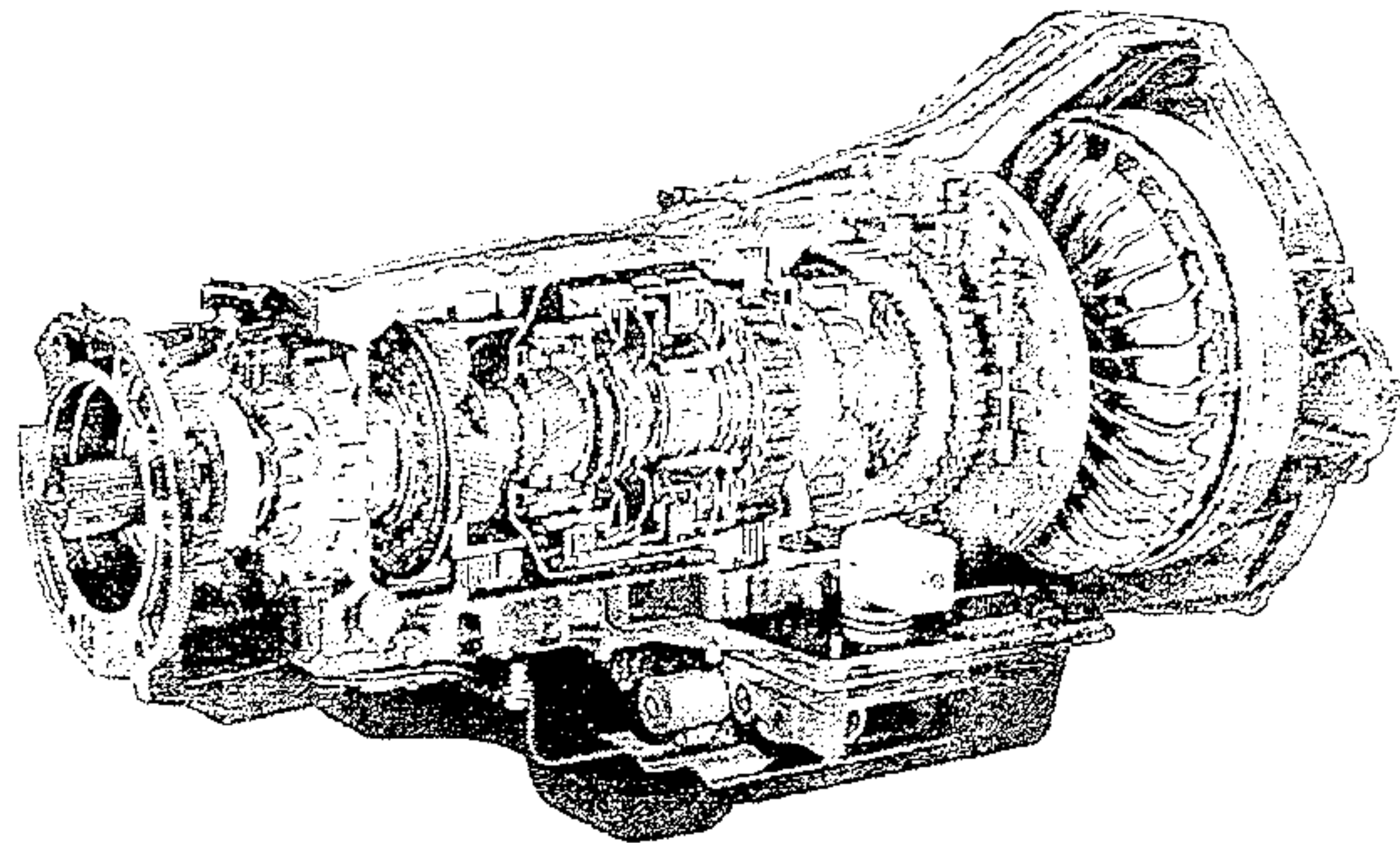

We proudly welcome all New Customers and Former Advanced Transmission Customers with a 10% Discount and Any Transmission Service or Repair\*

865-986-9359

865-986-5050

**Is Your Washer Broken?**

Call Me

I Only Charge \$100 Period!!!

Call Allen

865-617-7113

**Bad Credit, No Credit OK!!! We Finance Everybody!!!**

**Low Down Payment!!!**

Over 100 Cars, Trucks & Vans in Stock - Warranties On ALL Vehicles Sold!!!

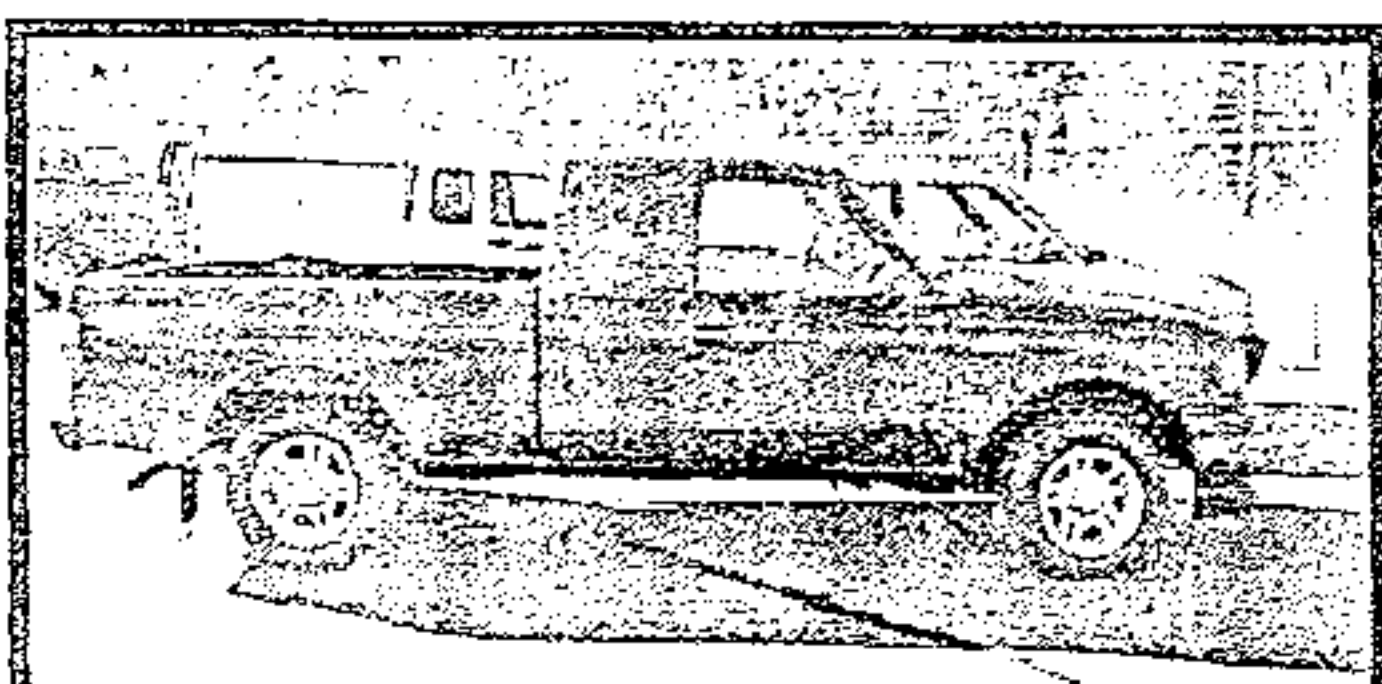

2005 Ford Ranger, Super Nice Truck, Very Low Miles

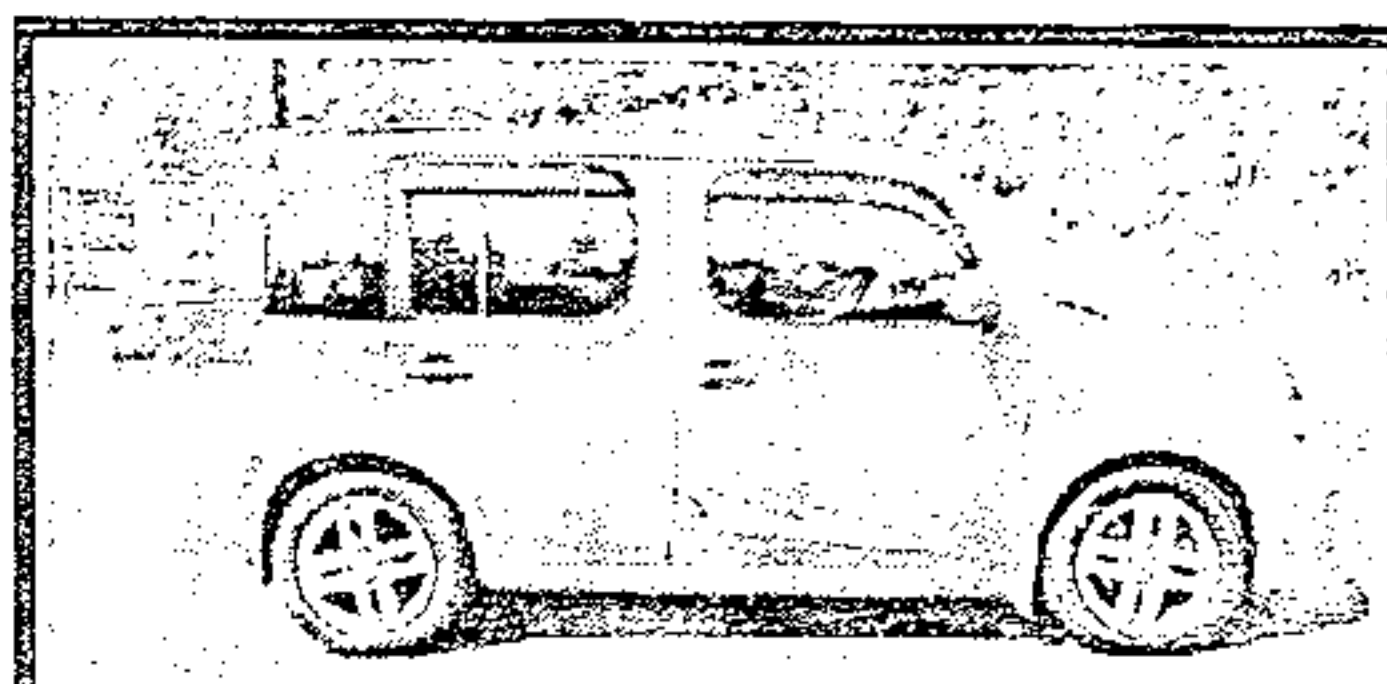

2009 Nissan Cube, Great Gas Saver, Clean

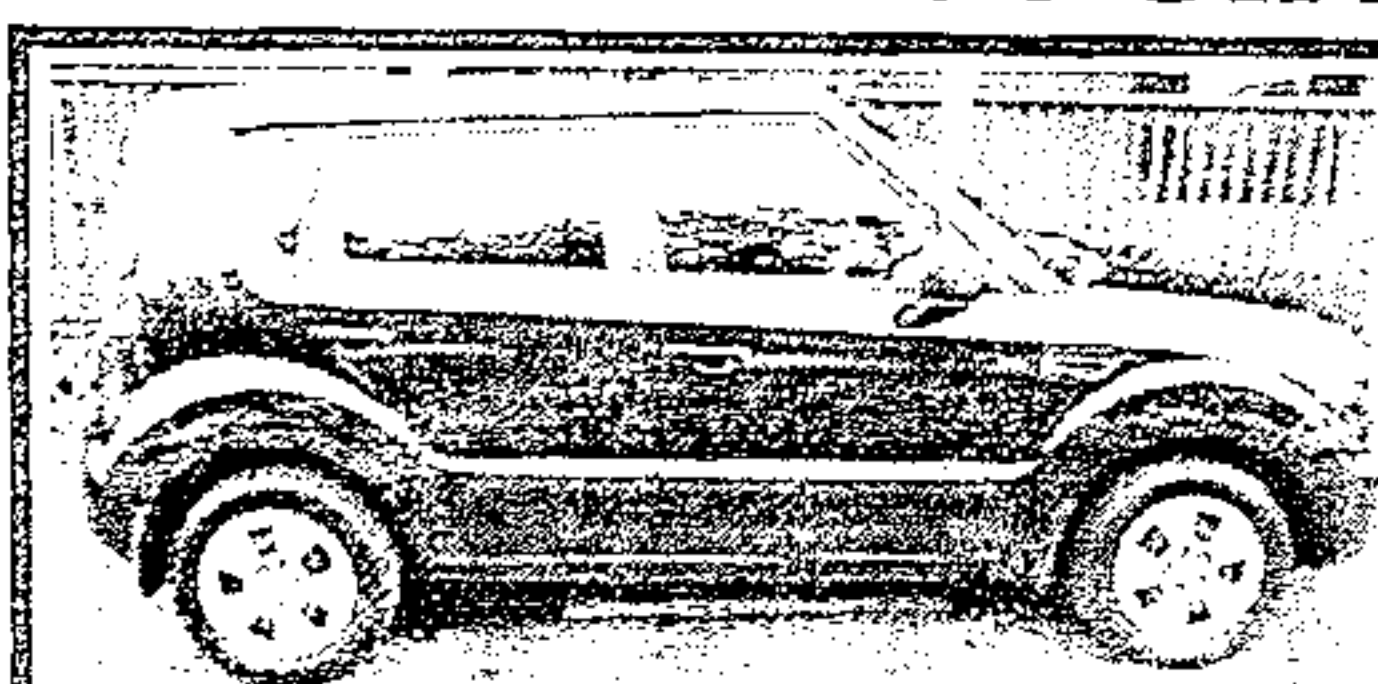

2011 Kia Soul, 5 speed, 4 dr, Gas Saver, Nice & Clean



2007 Chevy Equinox, 4dr, Extra Clean, lots of room

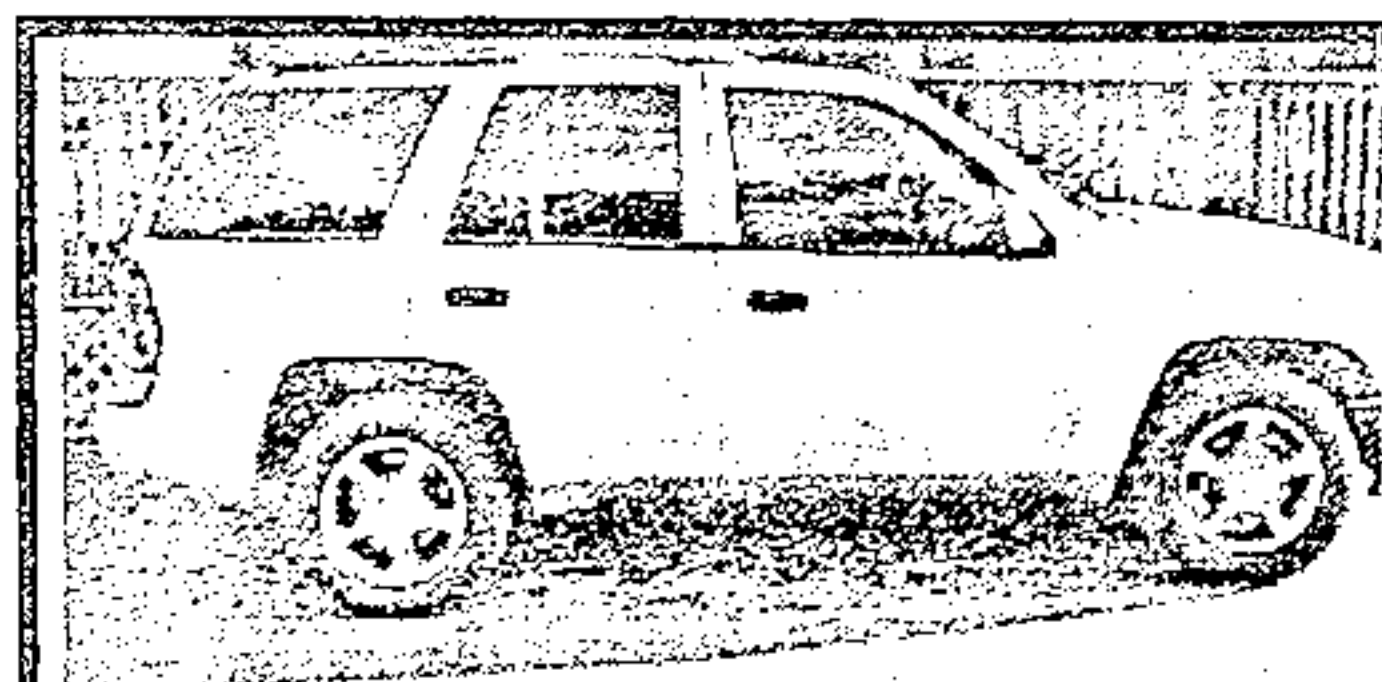

2008 Chevy Trailblazer, NICE! Loaded

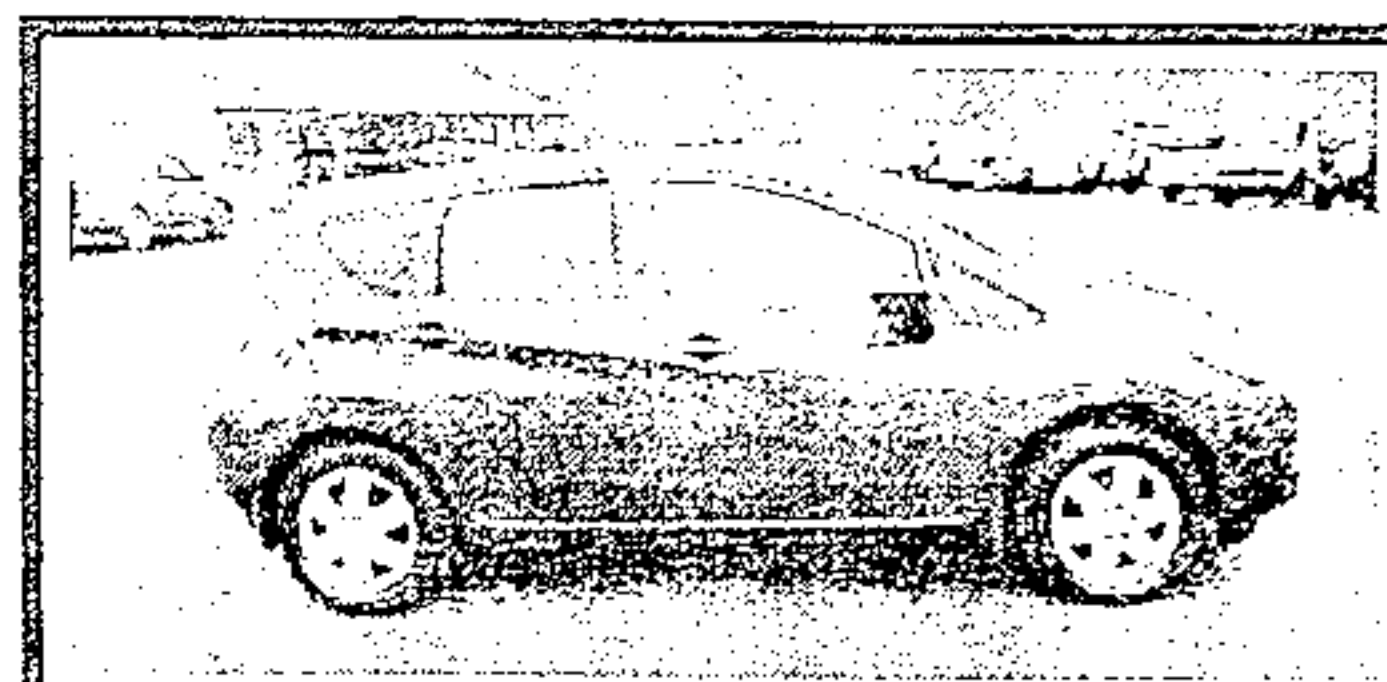

2015 Versa Note, ONLY 19k miles!, Factory Warranty!

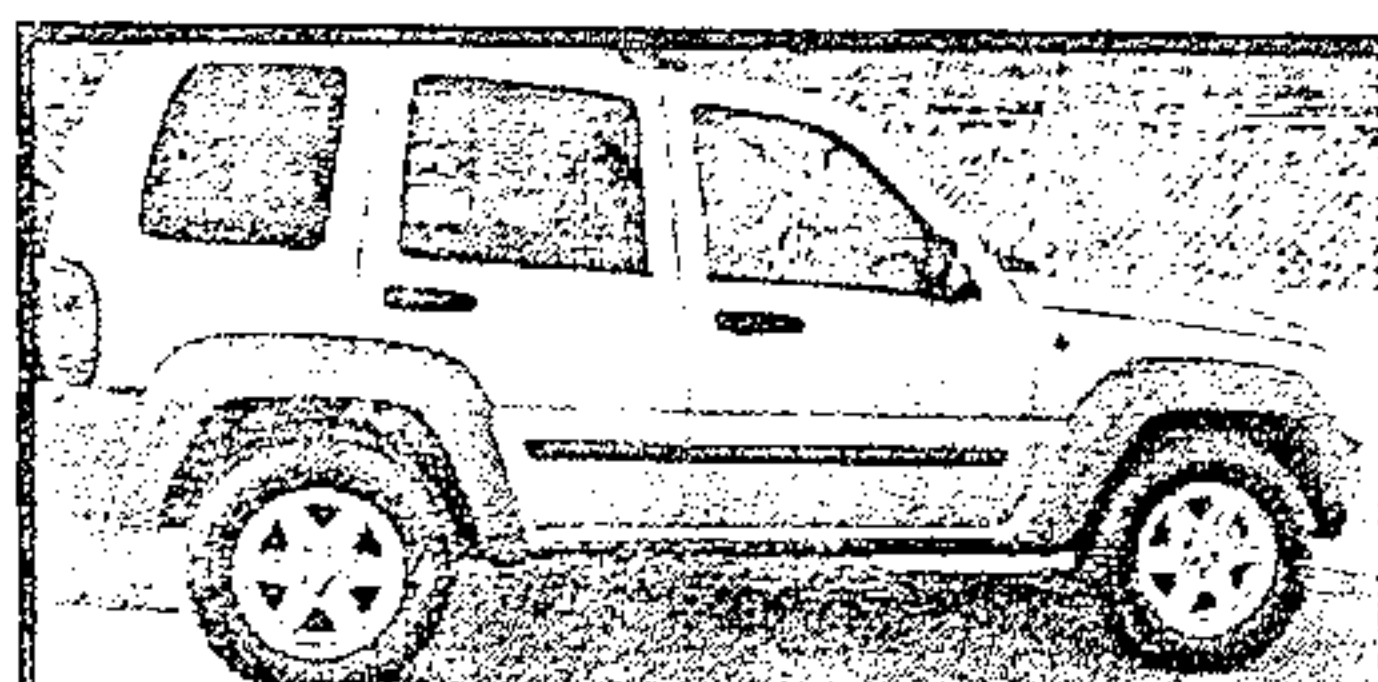

2004 Jeep Liberty, Nice, Extra Clean

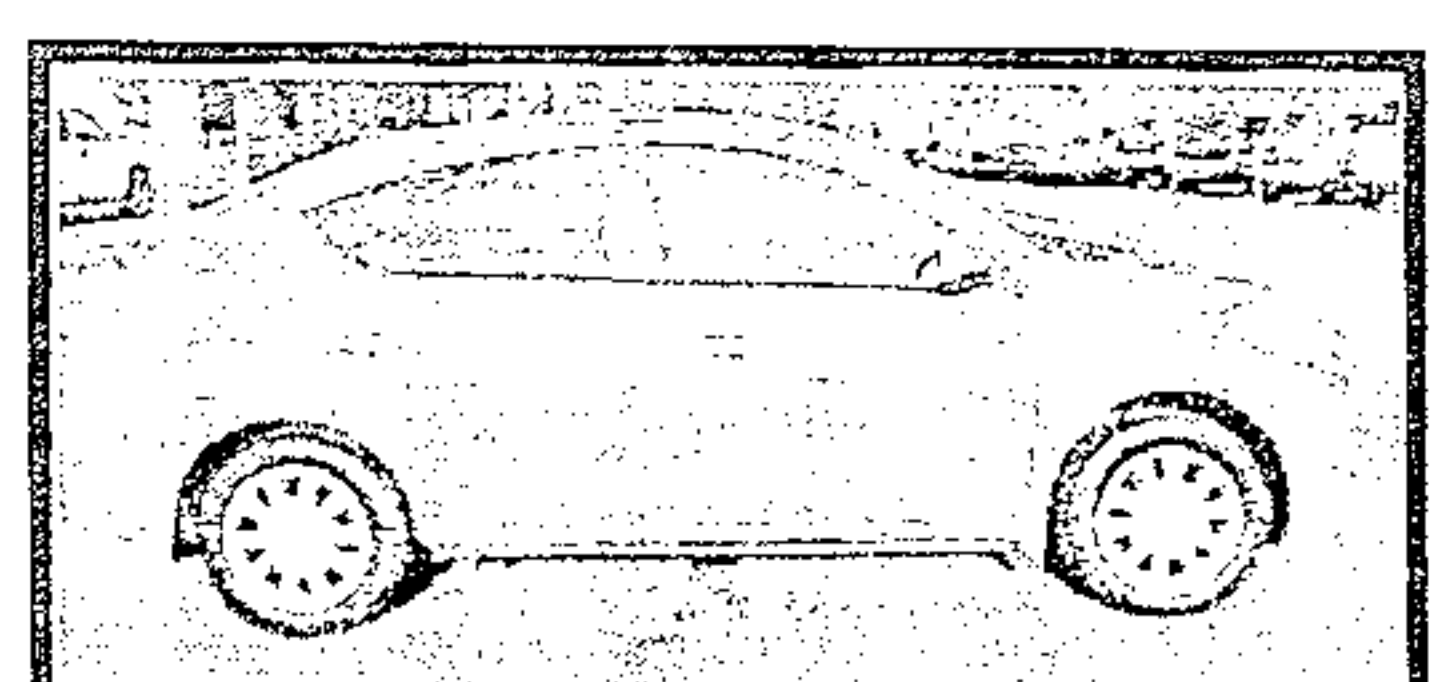

2013 Nissan Versa, Like New! LOADED!!!

**WALT WILLIAMS, INC.**

\*with approved credit

3003 Highway 11

Lenoir City, TN

865-986-1111