

The Daily Edition

50¢

Serving Loudon, Monroe and Surrounding Counties

Monday, November 30, 2015

Suspended driver charged with drugs in traffic stop



Steven McAbee

(see suspended pg. 3)

Man comes home late then goes to jail for assault

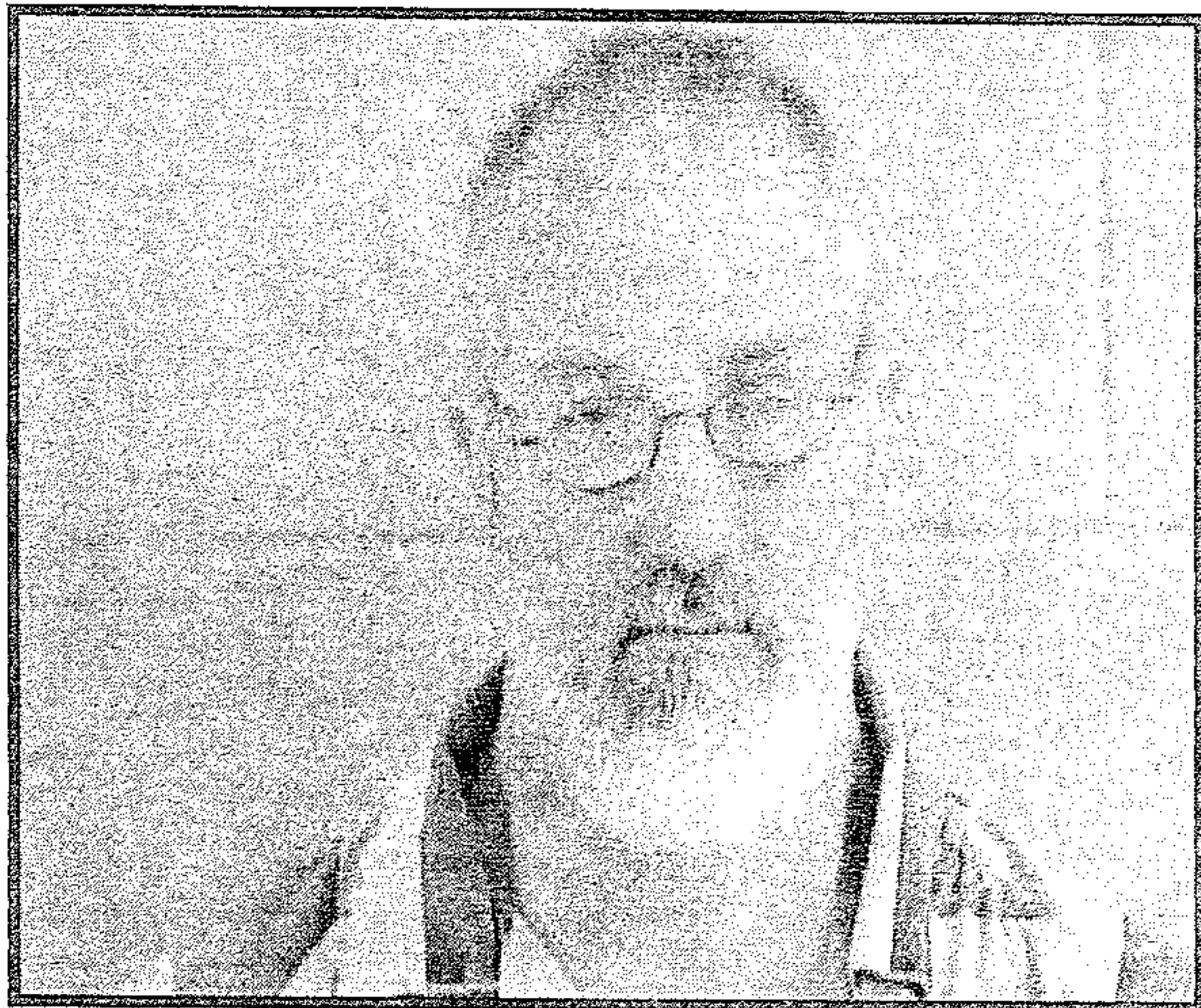

Michael Risher

(see assault pg. 2)

Agents of Asian Ancestry 'Historical Marker' Celebrates 50 Years of Service

When William Wang joined the FBI as a special agent in 1966, the number of known agents of Asian ancestry could be counted on one hand. There was no official tally, Wang said, because Director J. Edgar Hoover didn't find it necessary to keep count.

"Under Mr. Hoover, you are either a special agent or not a special agent," said Wang, who was born in China, im-

migrated to the United States in 1956, and became the Bureau's fifth known agent of Asian ancestry. "As far as he was concerned, we're all special agents—period."

Over the years, Wang took it upon himself to keep track of the number, and he reached out personally to new agents of Asian descent as they came through training at the FBI

(see service pg. 5)

Assailant flees scene and then resists arrest

Thomas Freeman, 42, Hwy 411 South Greenback, was charged with Domestic Assault, Evading Arrest, and Resisting Arrest. Deputy Chris Hutchens and Jamie Ketner LCSO, was dispatched to Hwy 411 S for a domestic. While in route to the residence it was reported that Thomas Freeman had fled the scene toward Blount Co. Deputy made con-

(see evading pg. 7)

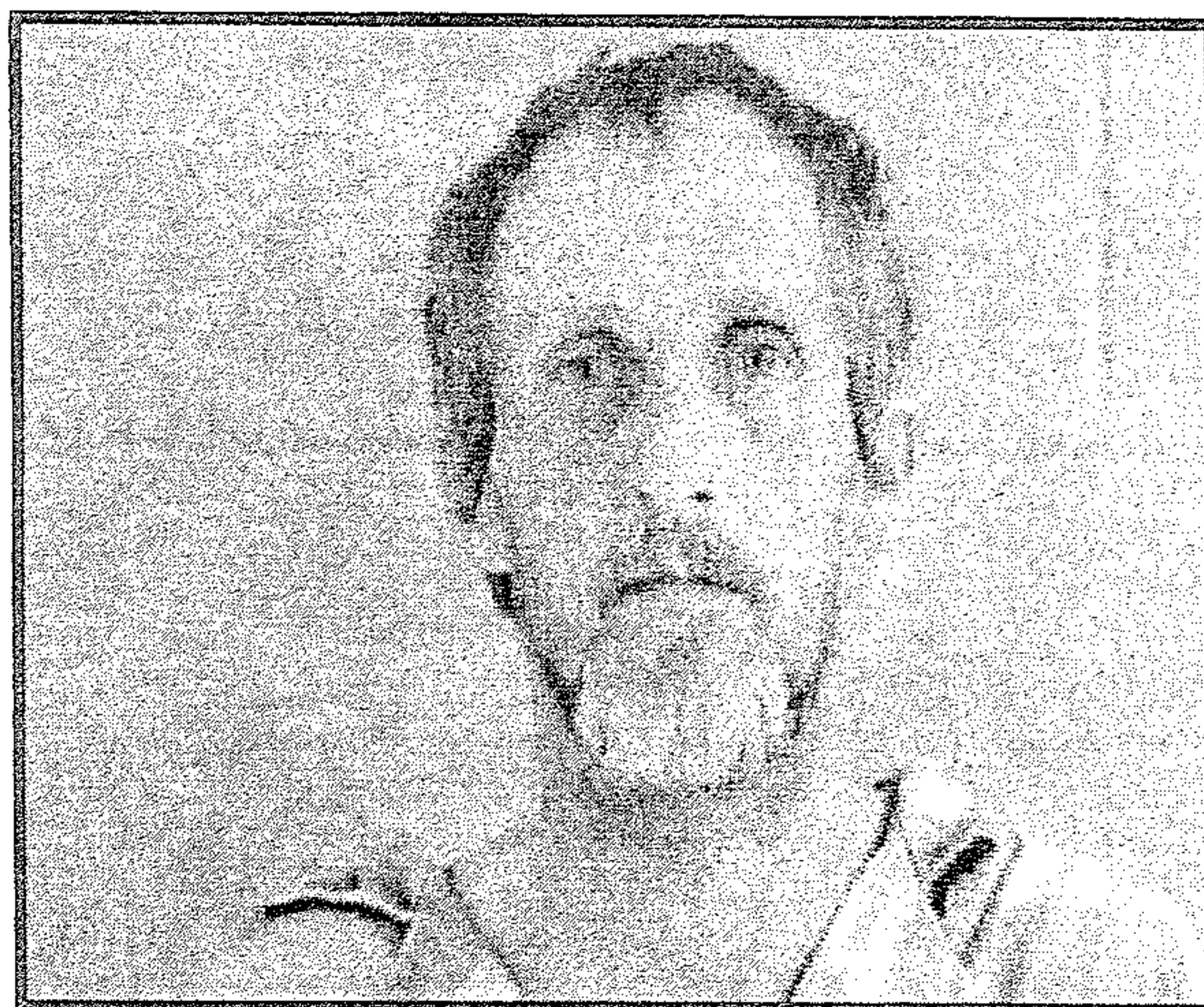

Thomas Freeman

2015 Biometric Identification Award

Virginia Police Investigator Honored for Role in Identifying Violent Perpetrator

The 2015 recipient of the FBI's Biometric Identification Award (formerly known as the Latent Hit of the Year Award) is a member of Virginia's Norfolk Police Department (NPD) who played a key role in the identification of a dangerous serial offender. Congratulations to Melvin Grover III, an investigator with the forensic section of the NPD's detective division.

This Criminal Justice Information Services (CJIS) Division award is traditionally given to a latent print examiner or law enforcement officer who solves a major violent crime using the FBI's Integrated Automated Fingerprint Identification System, or IAFIS. But IAFIS—our longstanding fingerprint repository—was replaced last year by the Next Generation

(see Award pg. 4)

Verse of the Day

For everything that was written in the past was written to teach us, so that through endurance and the encouragement of the Scriptures we might

have hope. — Romans 15:4

Obituaries

see inside

Wazzup

Today is Cyber Monday! Get online and get them crazy deals for Christ-

mas! This year is expected to be the largest ever online shopping experience.

Weather

Today: Rain. High 61F. Tonight: Rain. Low 52F. Tuesday Rain likely. High near 60F.

Tuesday Night Cloudy with showers. Low 46F.

Horoscopes

Sagittarius 11/22-12/21

You are often happiest heading out on your own, but now you may desire a sidekick while running

(Continued on page 6)



assault

Michael Risher, 43, Smokey Drive Loudon, was charged with Domestic Assault.

Officer James Gogdill LPD, was dispatched to Smokey Drive for a physical domestic call. Upon arrival Officer spoke to a victim. The victim stated that her

and her husband Mr. Michael Dean Risher got into a verbal argument about him coming home from work late and that Mr. Risher went to hug her and when she pulled away from him that he grabbed her by the arm and pulled her to the ground laying on top of her and cussing at her. Victim stated to officer that she felt threatened for her

safety at that moment. that's when this officer placed Mr. Risher under arrest for domestic assault. the above actions did occur in Loudon County.

Officer James Gogdill LPD, made the arrest.

Notice
 Vin 1G82557N87F202859
 General Motors Vehicle will be sold. If anyone has a lien on this vehicle contact: Homer's Body Shop, 10609 Beals Chapel Road, Lenoir City, 37772, 865-388-0372.

Notice: The Daily Edition does not knowingly accept fraudulent or misleading materials. The Daily Edition cannot guarantee the validity of offerings or statements contained herein. All liability for the contents of all advertising, and for any claims that may arise therefrom, is the responsibility of the advertiser or its agency. The Daily Edition reserves the right to reject, edit, or abbreviate any advertisement submitted. Advertising is accepted with the understanding that all liability for all copyright violations is the sole responsibility of the advertiser. Photographs, artwork and other copy submitted for publication is considered the sole property of the advertiser. The Daily Edition will make every effort but will not be liable for failure to publish and ad or for typographical and layout errors. All statements and information about highlights featured items, letters to the editor, herein are those solely given to the interviewer or writer and the Daily Edition assumes no responsibility of the accuracy or validity thereof. The Daily Edition will gladly reprint at no charge that part of an advertisement in which an error occurs provided a claim is made within 3 days of the first publication of the ad. Information contained in the Wazzup is received anonymously and the Daily Edition assumes no responsibility for information and reserves the right to edit or reject any and/or all submissions. The Daily Edition is a daily newspaper of general circulation in Loudon County defined under TCA 2-1-104(a)(13). The Daily Edition also serves Monroe, Knox, Anderson, Roane and Blount counties and serves 30,000 readers weekly. Send mail to PO Box 1240, Lenoir City TN 37771. 865-771-2249. email: dan1204us@yahoo.com
 The Daily Edition is Loudon County's premier public interest and paid advertising paper. The Daily Edition is produced and published daily Monday through Friday and is circulated throughout Loudon County and parts of Monroe and Knox Counties. Display advertising rates \$5.00 per column inch and quantity discounts available. Call for information on upcoming promotions and events.

HACIENDA Ayala's
 Mexican Restaurant
 Market Dr. * Lenoir City (In Front of Food City)

Real Authentic Mexican Food at Affordable Prices

BEST MARGARITA

You've Tried The Rest Now Come Have The Best!!!

We Accept ALL Competitors Coupons Outside of Mexico City!

986-3553

Good Credit OK • Bad Credit OK • Bankruptcies OK • Repo OK

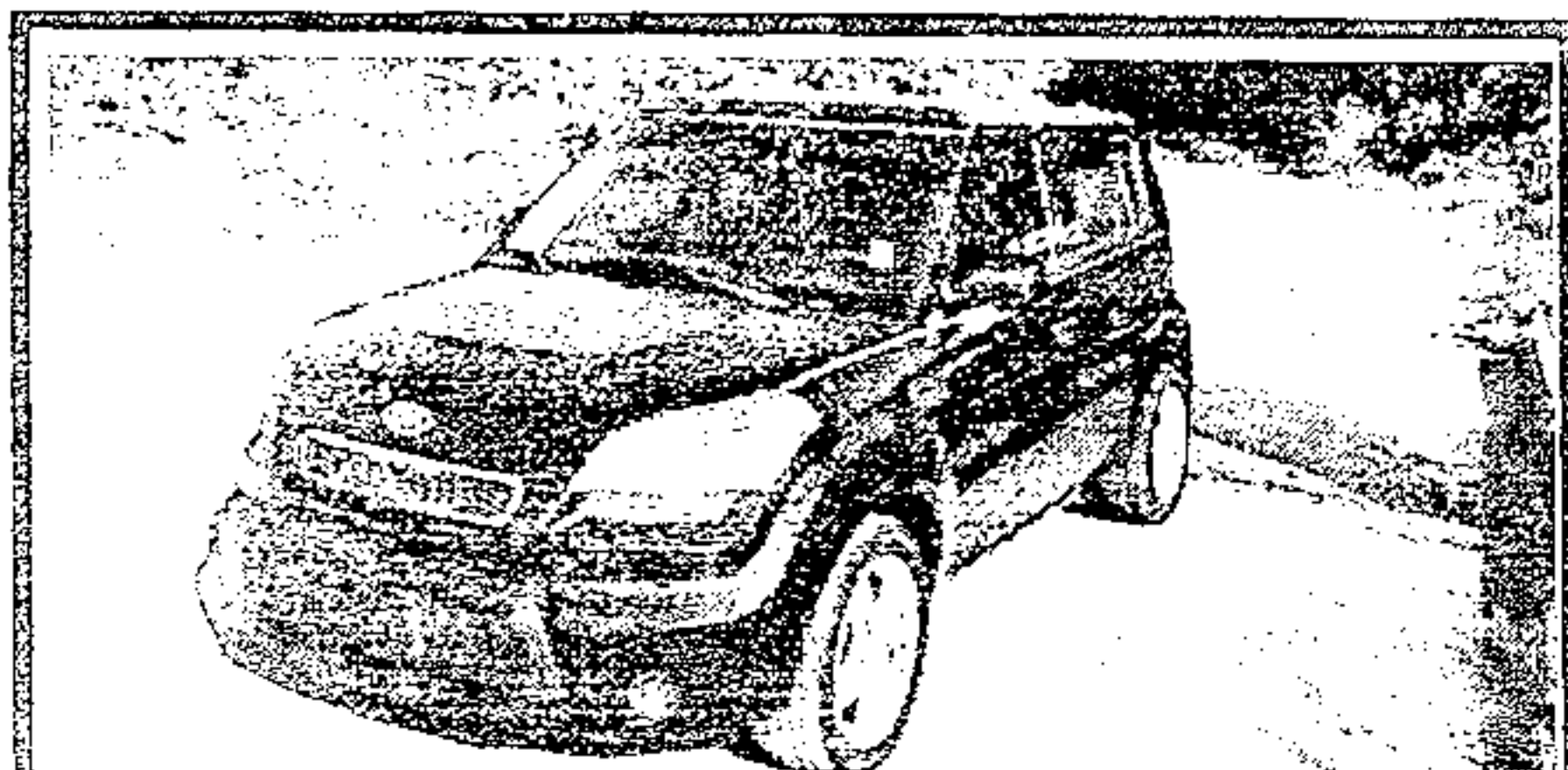

2010 Kia Soul Sporty, 4 cyl, Auto, PW, PL, A/C, Great On Gas, Like New

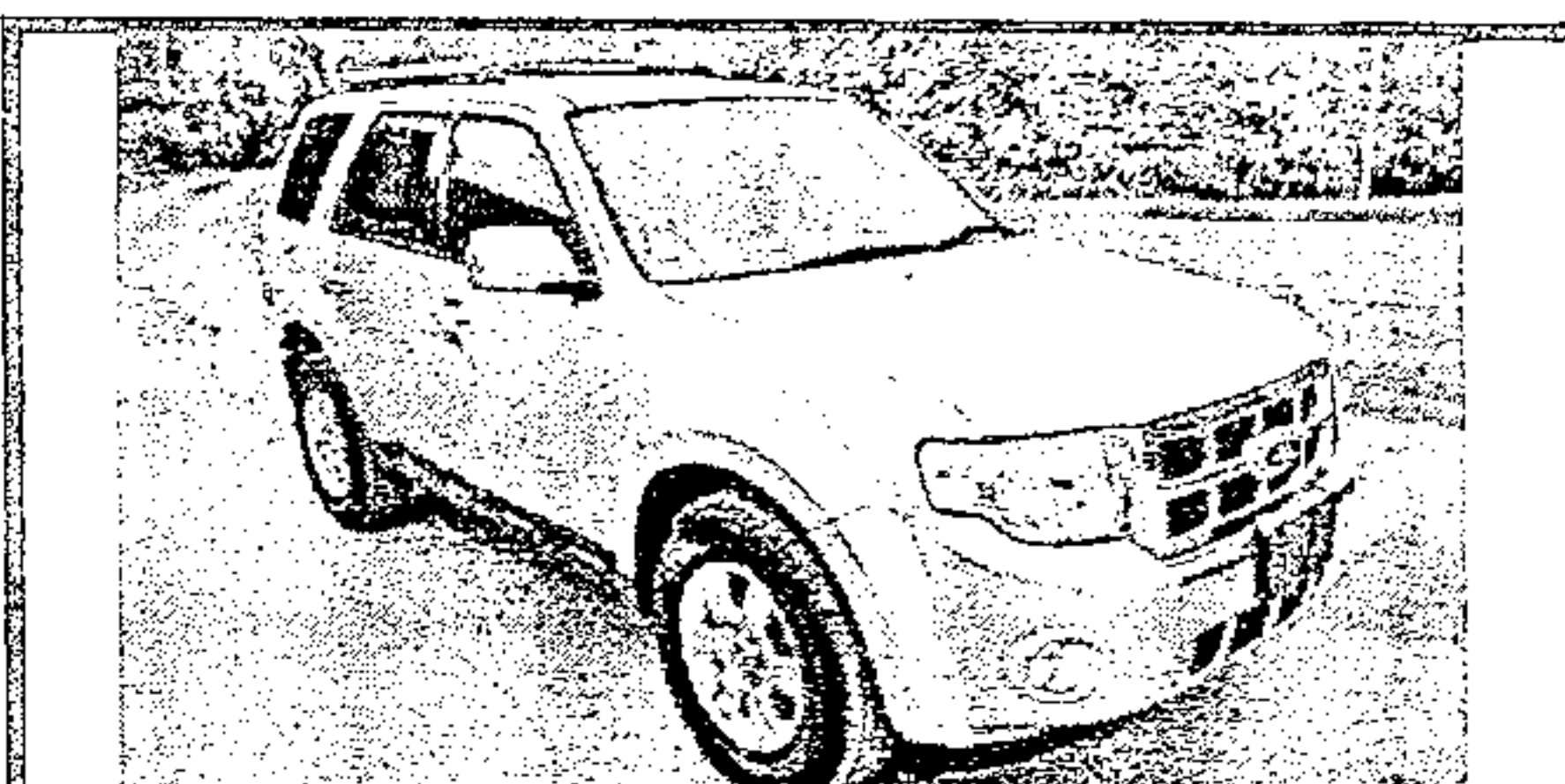

2010 Ford Escape Limited Leather, Alloy Wheels, Heat, A/C, Luggage Rack, 79K,

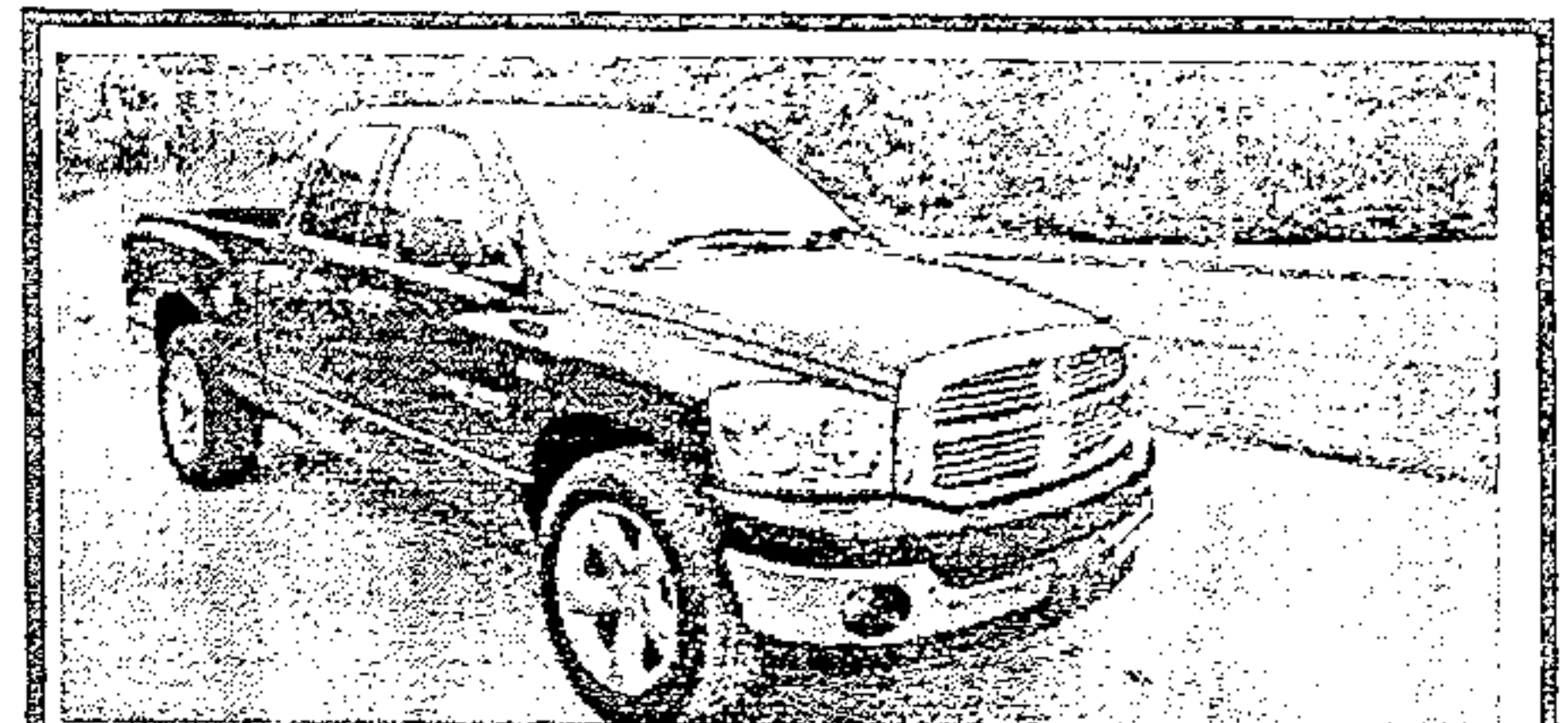

2007 Dodge Ram 1500 Quad Cab, Thunder Road PKG, 20 in. Wheels, Low Miles, Hemi



2008 Ford Explorer 84k, 3rd Row Seating, Luggage Rack, Tow Pkg, PW, PL

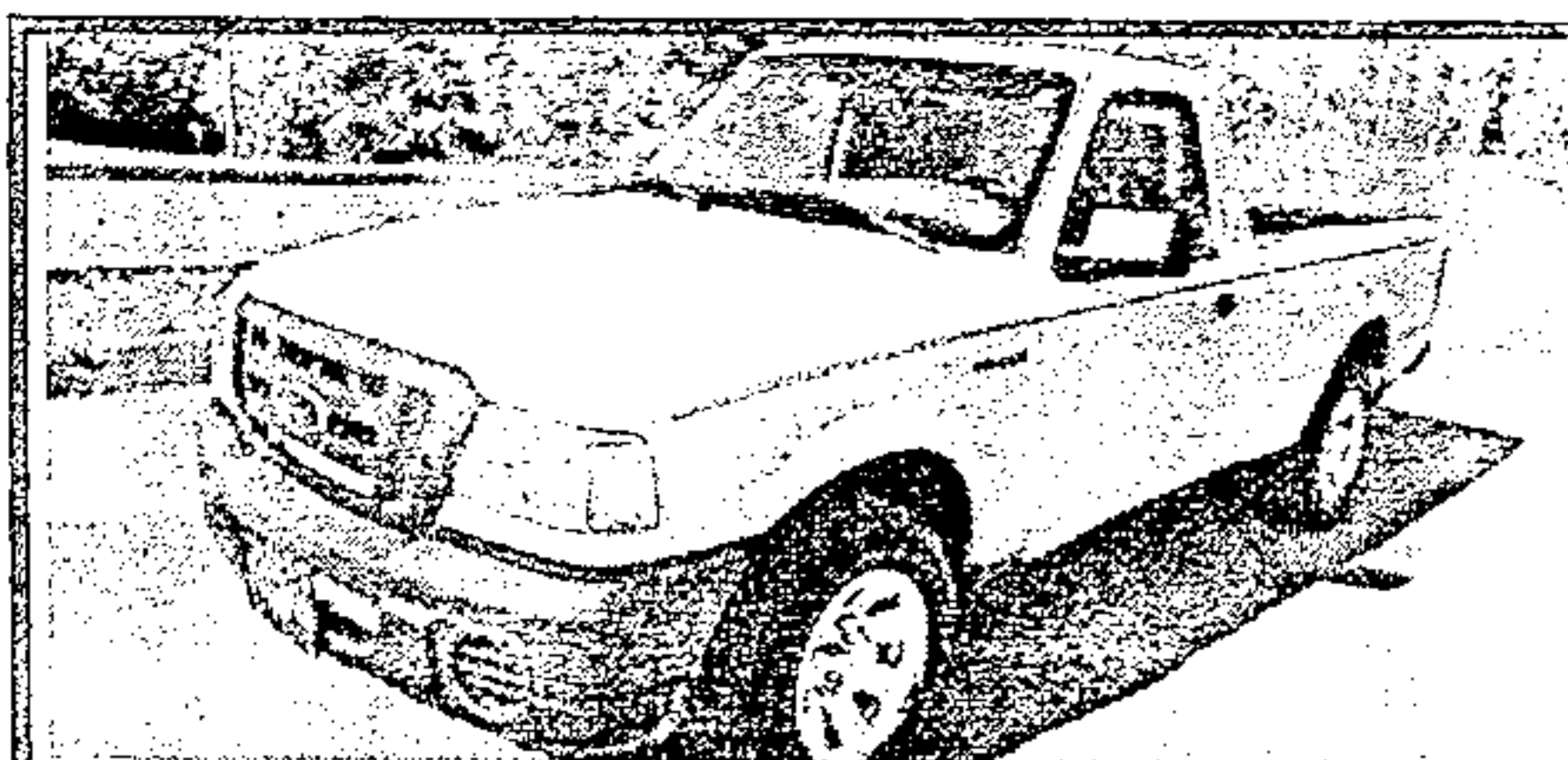

2011 Ford Ranger Low Miles, Tow Pkg, New Tires, A/C, Heat, Bed Liner.



2011 Dodge Grand Caravan DVD, Stow & Go, Loaded, Remote Doors, Rear A/C

DEPENDABLE MOTORS 986-9343
 803 E. Broadway • Lenoir City

Serving Loudon County for 20 Years

* WAC. See Dealer for details

Visit our website at: www.dependablemotorslc.com

suspended

Steven McAbee, 35, Candora Ave Knoxville, was charged with Driving on Suspended license, Poss. of Legend Drug, and Poss. of Drug Para.

According to the report, Deputy Lance Anderson LCSO, observed a blue vehicle traveling on Hwy 411 displaying a un illuminated license plate. Deputy made traffic stop and contact with the driver Steven McAbee. A check of Steven through dispatch revealed his license were suspended.

Upon consent to search vehicle Deputy did locate in the driver side door 2 syringes, and 18 yellow barrel shaped pills believed to be Gabapentin in the center console.

Steven was placed under arrest. Deputy Lance Anderson LCSO, made the arrest.

Obituaries

Mary L. Dishner - age 79 of Lenoir City, passed away Friday, November 27, 2015. She was a member of Fellowship Baptist Church. Preceded in death by her husband of 50 years, Billy Lee Dishner; son, Greg Dishner and siblings, Katey Lee, Dorothy (Dot) Belcher, Betty Shubert, Bob Williams, Charlie Williams

and Ernie Williams. Survived by her grandson, Brandon Dishner; several nieces including, Dianne Munsey; sister, Opal Ellis; special friends, John, Petula, Devin and Dakota Caylor. The family will receive friends from 11 a.m. to 12 noon on Monday, November 30th at Click Funeral Home in Lenoir City. Funeral services will follow at 12 noon with Rev. Eddie Chasteen officiating. Interment

will follow at the Loudon Co. Memorial Gardens. Click Funeral Home, 109 Walnut Street, Lenoir City is in charge of arrangements.

James F. Park of the Tellico Village Community, Loudon, TN passed away November 25, 2015. Private, family services will be held. Click Funeral Home & Cremations - Tellico Village Chapel is serving the family of James Park.

For Sale: Oak Wood Mulch



Mushroom Compost Topsoil.



Firewood

Call Steve Spoon
986-4282

West End Storage & Warehouses
502 Ward Avenue • Loudon
Call 865-458-4774 or 865-679-5555



C&C Lawn Care
 Mowing, Mulching, Trimming, Edging, Clear Debris
 Free Estimates
 Call Chad 865-271-8070



BIMBO'S
 Deli Open 24 Hours
 865-986-9643 Call Ins Welcome
 Specials
 Lg. Cold Sub, bag of chips and 16 oz. fountain drink
 only \$6.29
 Footlong Corn Dog \$2.59

C&J Towing and Recovery
LOWEST TOWING RATES AROUND!!!

Have you been overcharged for any type of towing service in the Lenoir City area? If you have a breakdown or accident please OWNER REQUEST C&J Towing with the officer. Also please call your Sheriff and ask him to place C&J Towing on the "Rotation List*" and help other motorists save as much as you did! We at C&J are locally owned and operated, State approved, licensed, bonded and insured. Call and let us know if your denied service or how we can be of assistance.

*note: the "Rotation List" is a list of wrecker services that provide service for wrecks, DUI's, breakdowns, etc. and are on an on-call basis for service. This list is approved by the Sheriff.

Cliff Teeters • Owner
865-809-1661



award Identification (NGI) system, developed to expand the Bureau's biometric identification capabilities and services, and future awards will involve the use of the NGI system.

The case Grover eventually became involved with started in August 2008, when the NPD received an emergency call from a private residence and responding officers found a female tied up in a locked bathroom. The victim, a U.S. Navy officer, said that she had been sleeping and was awakened by an unknown male brandishing a knife. The man raped her, bound her legs with the cord of an iron, and stole items from the home before fleeing.

Investigator Wade Stalker of the NPD processed evidence from the scene, including latent fingerprints from the iron and a door. Grover searched all the latent print evidence against Virginia's Automated Fingerprint Identification System but got no results.

In September 2008,

the victim and her daughter returned home one day and were confronted by the same attacker. He tied them both up with duct tape and raped the daughter before fleeing the scene. Once again, investigators collected evidence, including latent fingerprints and DNA. The prints were compared against Vir-

ginia's system, which didn't produce any known suspects but did confirm that the same individual committed both crimes. Investigators also searched the collected DNA evidence against the FBI's Combined DNA Index System, or CODIS, with no results. The case remained un-

solved. In the spring of 2010, a female service member stationed in Kuwait was attacked while in a shower. An unknown male with a shirt covering his face went after the victim with a box cutter, but she fought back and the suspect ran off. Person- (see award ctd. pg. 7)

SARCO Enterprises Inc. Offers Complete Home and Commercial Remolding and Repairs

Our Team members have a combined total of over 40 years experience in all areas of home construction, facilities maintenance and commercial construction. Roofing, Electrical, Bath and Kitchen Renovations, we do it all with just one call. We are fully insured and our work is guaranteed.

Call us today for a free no obligation quote for your next project. 865-809-9492.

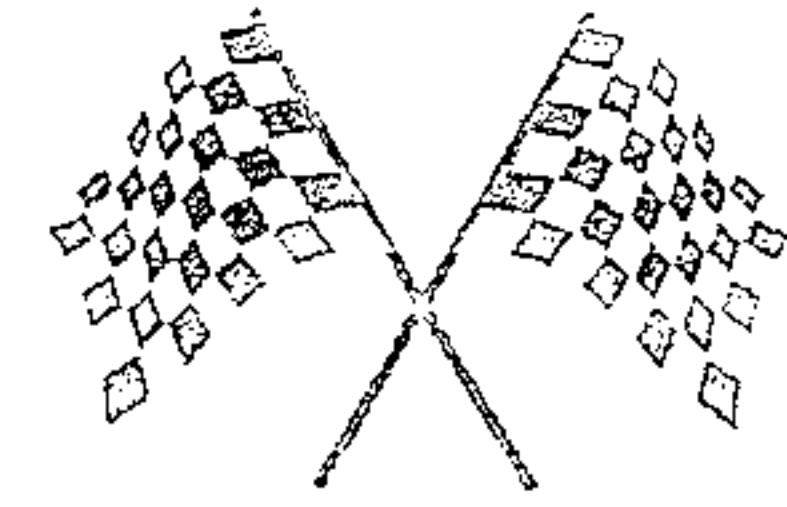

SOUTHERN AUTO DETAILING
414 WEST BROADWAY
LENOIR CITY, TN 37771
865-986-0724

Starting at \$34.95
Present this ad for \$5.00 off

BUDGET
Transmissions

Why Buy From Budget?

- Free Towing From Lenoir City or Loudon County
- 20 Years of BBB Zero Customer Complaints Award Member
- A+ Plus Rated
- Huge Transmission Inventory
- Best Technicians Period!!!

Call (865) 584-4391 Today!

302 S. Northshore Drive Knoxville
(865) 584-4391

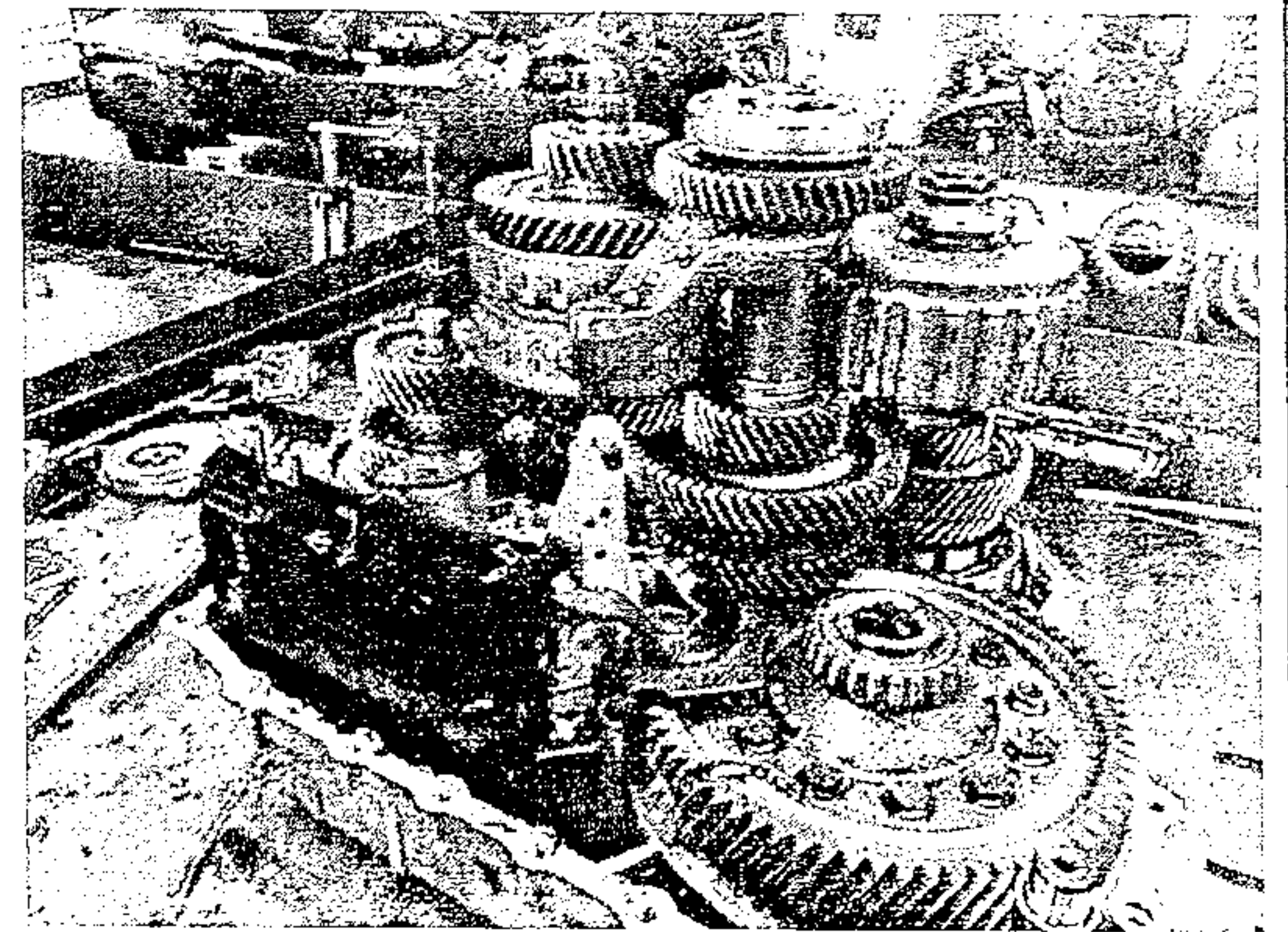

budget-transmissions.com



Approved Auto Repair



service

Academy in Quantico, Virginia. "It was important to me to just let them know that I'm here," he said.

The role of agents of Asian ancestry over the past 50 years—since Edwin Yee and Calvin Shishido were sworn in as agents in 1965—was a centerpiece of this year's annual national conference of the Society of Former Special Agents of the FBI. Retired Special Agent El-

len Glasser, who was president of the society during the September gathering in Reno, Nevada, said it was a fitting time to honor them for the "special value and needed diversity" they brought to the FBI's ranks.

"We decided this was an opportunity to do something really important and to create a historical marker for their 50 years of service," Glasser said, speaking to hundreds

of former agents, but specifically addressing the cadre of Asian former agents in attendance. "By celebrating your achievements and your loyalty, we here in the FBI family want to publicly say thank you and job well done."

In conversations, many recalled being recruited into the Bureau specifically because of their backgrounds, both professional and ethnic.

Kingman Wong, who

served from 1988 to 2012, said the San Francisco Field Office was looking for agents with Chinese language skills when he was recruited. He landed on an Asian organized crime squad there, which propelled him to other undercover assignments in Hong Kong and Thailand.

"In terms of infiltrating these groups, you have to know the culture, you have to know the language," he said. "It would be very dif-

ficult if the Bureau sent in a Caucasian agent."

Chris Loo also worked in the San Francisco office, from 1978 to 1999. He remembered his boss assigning him to applicant recruitment, specifically to reach out into the Asian community. He did that successfully for two years—hiring a number of future legal attachés to run our overseas offices—before returning to an organized crime squad, where he helped launch the office's Asian organized crime program.

"Your ethnicity certainly helps open doors in the community," said Loo, recalling an interview with a potential witness who was Chinese. "He was very hesitant to speak to me, and his sponsor said, 'Don't be afraid to speak to Mr. Loo. He's with the FBI and he's Chinese.' I found the ethnicity a plus in helping to get the foot in the door."

The former agents also encountered some strains of discrimination but generally brushed it off and rose above it. JoAnn Sakato, who served from 1978 to 2002 and was the first Asian woman agent in the FBI, chalked up any racist or sexist slights to ignorance.

"As a Japanese female, I think some of the agents expected a geisha," she said. "Well, that's not what they got when they hired me. A funny story is that in the Los Angeles Field Office they would call me Dragon Lady. I suppose in some contexts it could be a derogatory term. I decided to adopt that as my moniker and made it my own. I guess I established certain reputation for

(see service ctd., pg. 8)

PURDY'S AUTO PARTS AND SALVAGE

WE BUY SCRAP IRON • COPPER • BRASS • ALUMINUM

\$

Paying Top \$\$\$

Call For Latest Prices

You Name It, We Buy It!

Radiators, Wheels, Batteries, Appliances, Farm Equipment

Complete Cars

per 100 lbs.

Copper

Paying Top \$\$\$

Call For Latest Prices

Scrap Metal

Paying Top \$\$\$

Call For Latest Prices

per 100 lb

We Buy Batteries

Aluminum Cans

Paying Top \$\$\$

Call For Latest Prices

You Call We Haul!

423-519-5402

*Prices subject to change with the market.



Now Selling Aftermarket Body Parts at Discount Prices

423 337-3977

149 County Road 323 Sweetwater

*Prices subject to change with the market.

attack

tact with the vehicle turning onto Niles Ferry Road near the Corner Market, Deputy immediately turned on his emergency light and sirens. Thomas accelerated the vehicle and began fleeing traveling at a high rate of speed. Deputy continued to pursue Freeman as he turned onto Dotson Road and then back onto Hwy 411 before speeding back into the driveway at his residence.

Once there Thomas jumped out of the vehicle utterances about wanting to be killed and have suicide by police done to him, and refused all command by Deputies. K-

9 Dante was deployed and apprehended Thomas. Thomas was taken to Ft. Loudon where he was treated and released. Witness and victim gave statements on the Domestic that Thomas had began yelling and then began smacking and shoving victim. Deputy Chris Hutchens LCSO, made the arrest.

award ctd. from pg. 4

nel from the U.S. Army Criminal Investigation Command collected blood samples from the shower and from a secondary crime scene where a blood-stained shirt was recovered from the trash. DNA isolated from the blood samples was searched against CODIS and

positively linked to the two 2008 attacks in Norfolk. But the actual identity of the attacker remained unknown.

In January 2012, representatives from the Naval Criminal Investigative Service (NCIS) met with Investigator Grover of the NPD to discuss the cases, and latent fingerprint evidence from both crimes scenes was searched against the Bureau's IAFIS, with negative results. Later on, NCIS contacted the CJIS Division's Latent and Forensic Support Unit (LFSU) to coordinate investigative efforts with the NPD. LFSU personnel conducted an internal search of the latent fingerprints collected

against the Bureau's repository of civil prints—at that time, IAFIS—and forwarded possible candidates to Investigator Grover. Grover was able to determine that the prints matched those of Amin Garcia, who had served in a Navy reserve unit and whose time in duty stations in Norfolk and Kuwait coincided with the attacks.

NCIS was then able to obtain a sample of Garcia's DNA, which matched the DNA

evidence left at the Norfolk and Kuwait crime scenes. In January 2014, Garcia was arrested in New York City and extradited to Virginia.

Garcia was convicted after a three-day trial for his crimes in Norfolk, and in December 2014, he was sentenced to life in prison plus 120 years. For the Kuwait attack, he was indicted in October 2014 by a federal grand jury, and that case is still pending.

Is Your Washer Broken?

Call Me

I Only Charge \$100 Period!!!

Call Allen

865-617-7113

LOOK! \$75 Weekly Payments LOOK!

MARTY'S AUTO SALES • 986-2222 • MARTY'S AUTO SALES • 986-2222 • MARTY'S AUTO SALES • 986-2222 • MARTY'S AUTO SALES • 986-2222 • MARTY'S AUTO SALES • 986-2222 • MARTY'S AUTO SALES • 986-2222

Bad Credit
Divorce
Fixed Income
Repos
Bankruptcy
No Credit

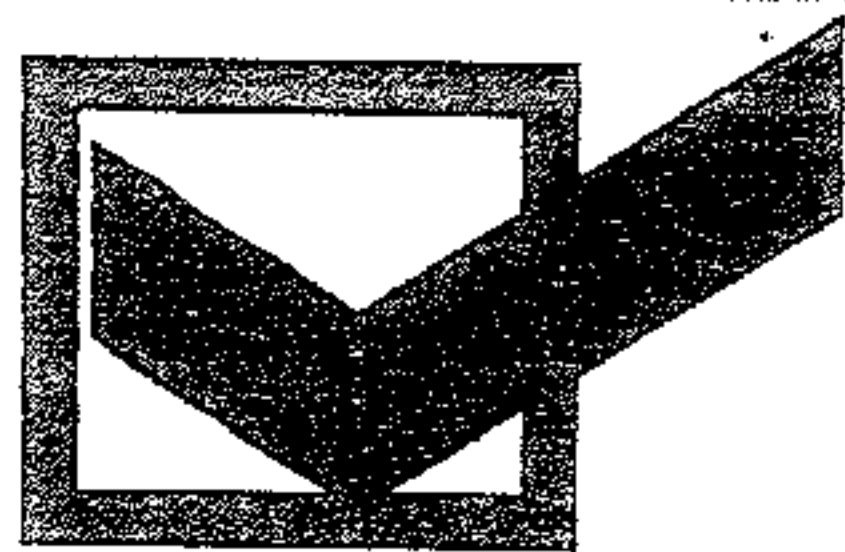

APPROVED!

Visit Us On The Web At:
martysautosales.net

NO CREDIT CHECKS

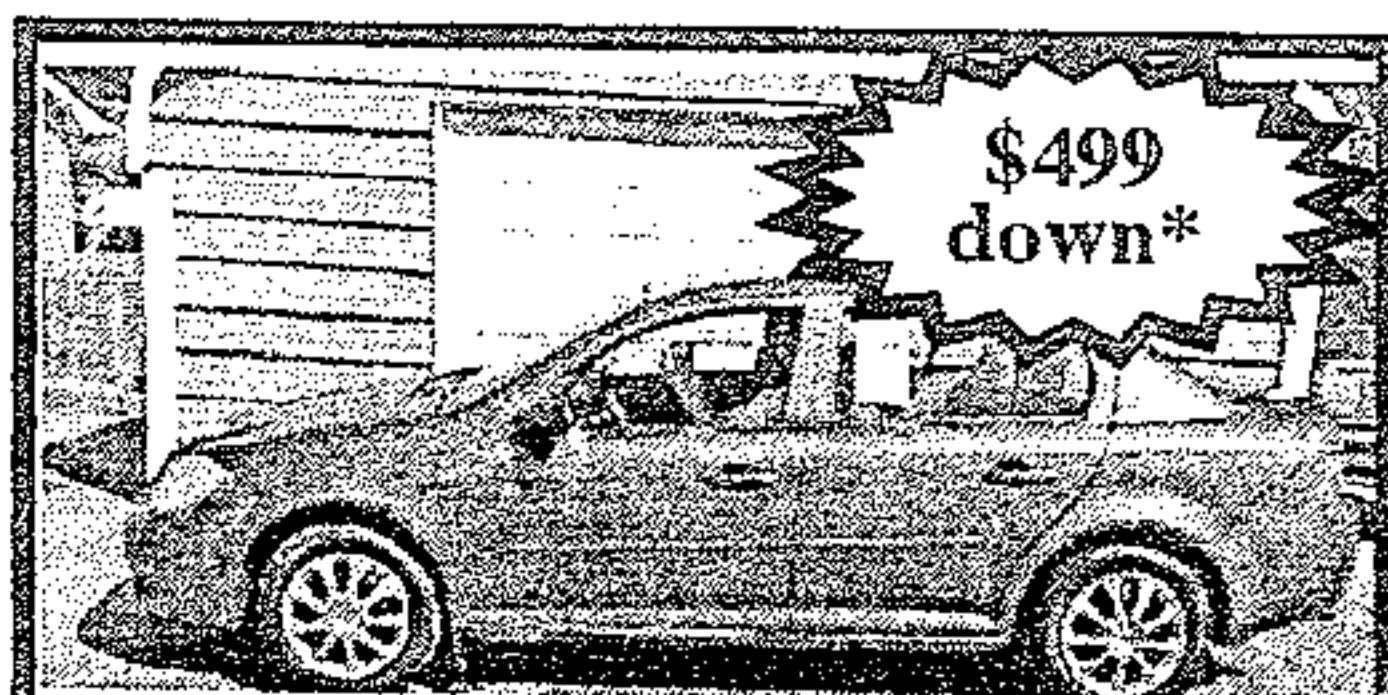

\$499 down*

07 Cobalt, 5spd, gas saver, runs great Only \$499 down *



\$499 down*

02 Sable, sunroof, loaded, Only \$499 down *

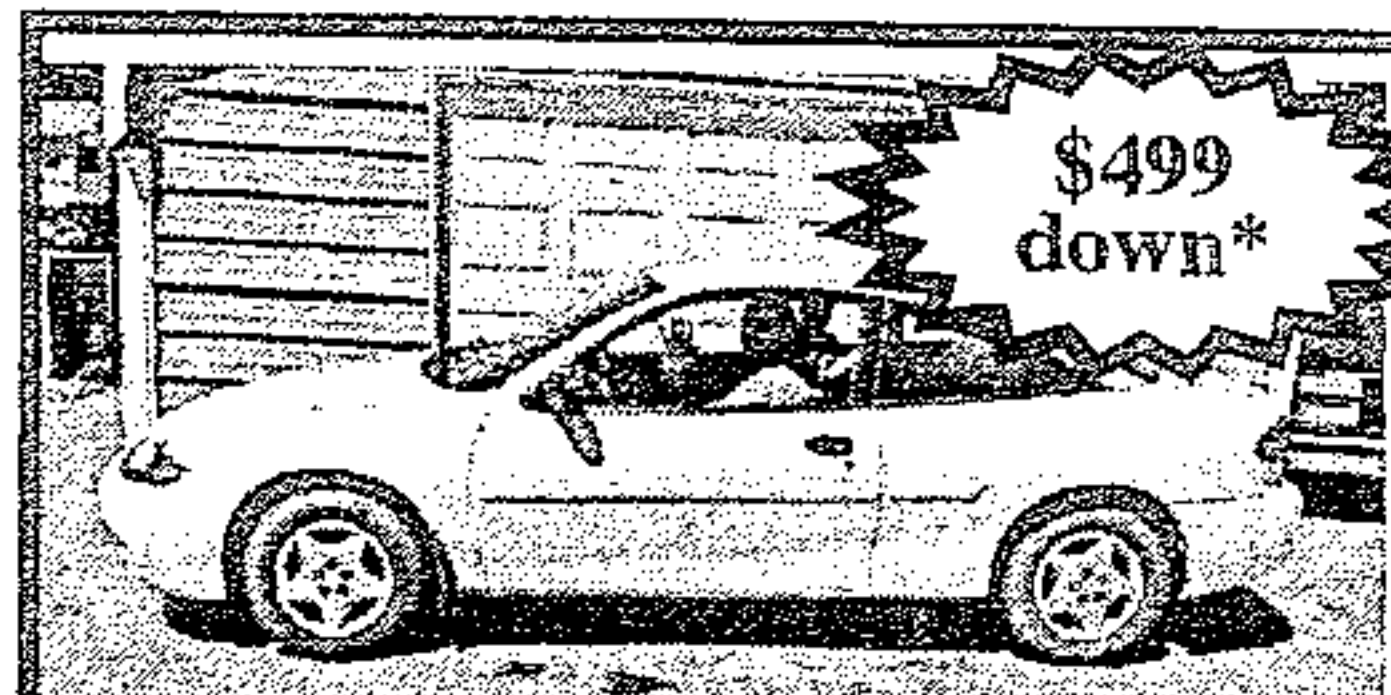

\$499 down*

04 Cavalier, 2dr, Sporty, Only \$499 down *

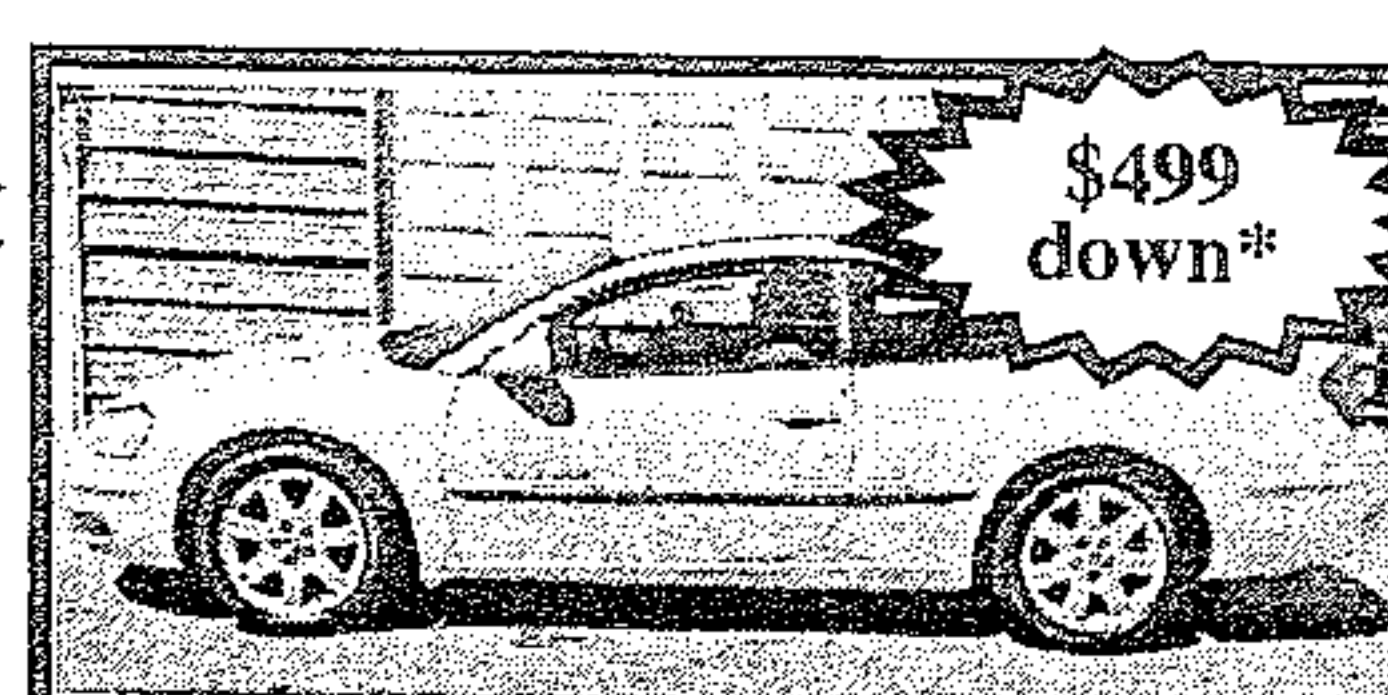

\$499 down*

01 Sebring 2dr. sporty, Only \$499 down *

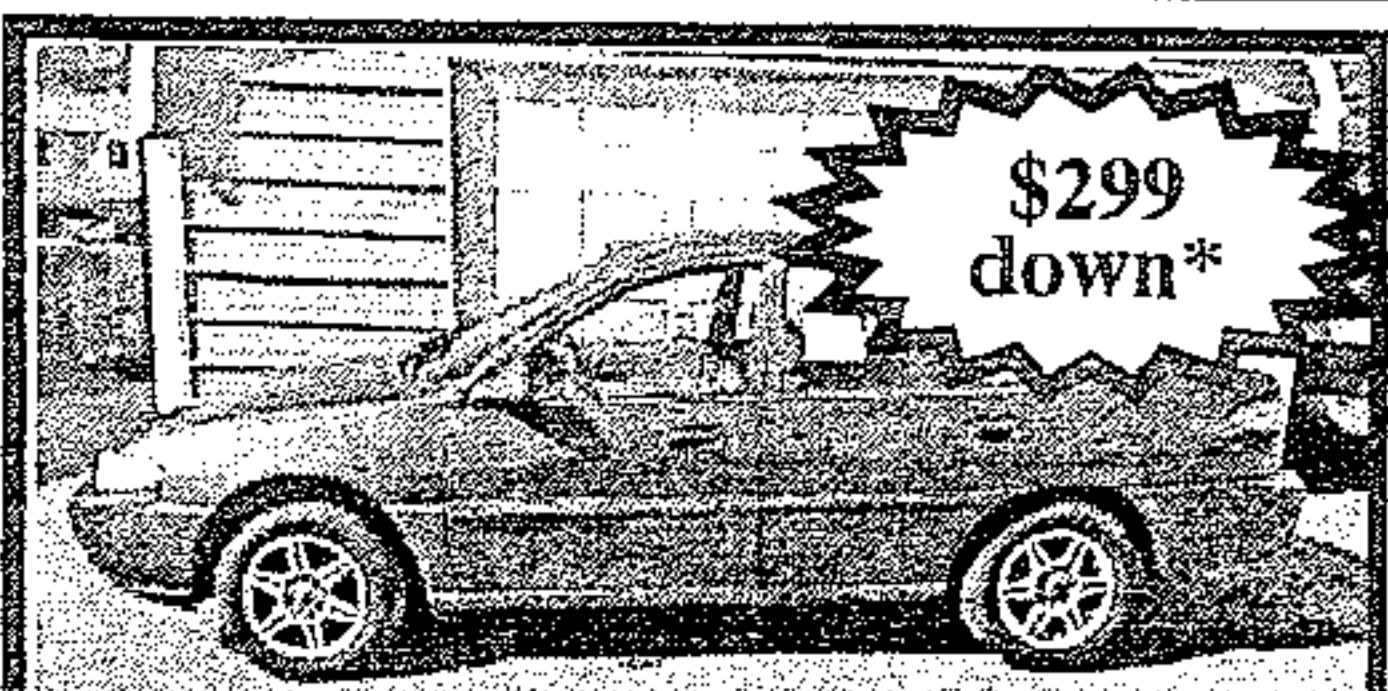

\$299 down*

97 Escort, auto, Gas Saver, Only \$299 down *

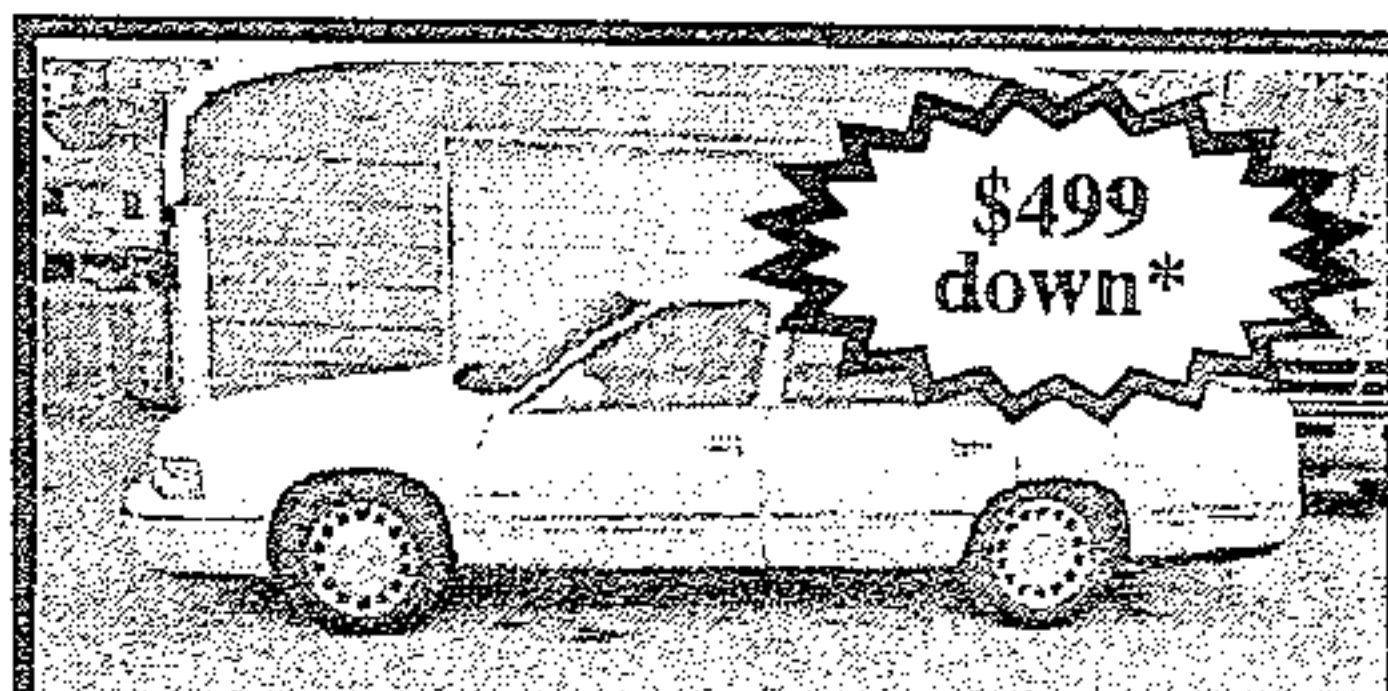

\$499 down*

99 Deville, Loaded, Luxury, Nice Only \$499 down *

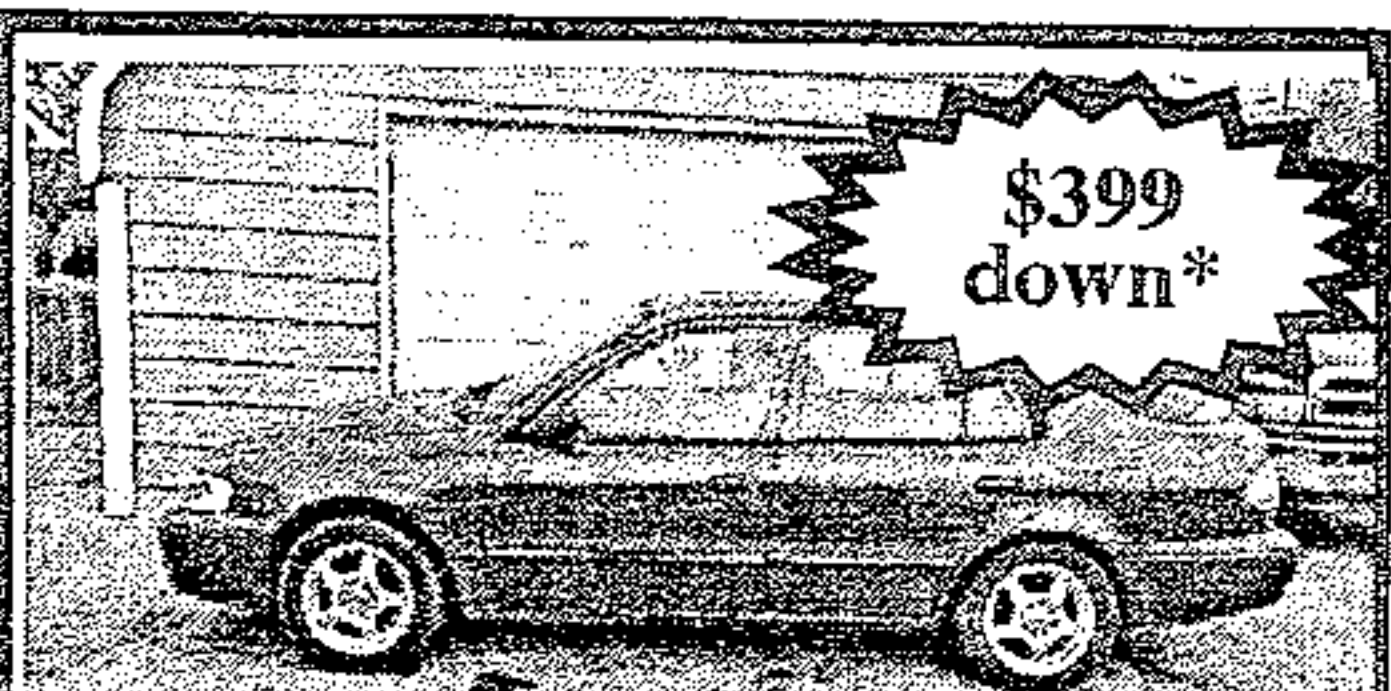

\$399 down*

99 Corolla, auto, Gas Saver, Only \$399 down *



\$499 down*

00 Ram, High Top Conversion Van, Loaded only \$499 down *

NO Credit Checks

Marty's Auto Sales
986-2222

Se Habla Espanol

100% Approval*

*See Dealer for details. All down payments plus tax, tag, title and fees.

MARTY'S AUTO SALES • 986-2222 • MARTY'S AUTO SALES • 986-2222 • MARTY'S AUTO SALES • 986-2222 • MARTY'S AUTO SALES • 986-2222 • MARTY'S AUTO SALES • 986-2222

service ctd. from pg. 5

taking no prisoners. I adopted that, and that was my persona."

Today there are nearly 600 active special agents of Asian ancestry, a figure roundly regarded as too low. Director Comey frequently cites the FBI's diversity statistics in public remarks about how the FBI needs to better reflect the people it serves.

"Diversity is about doing the right thing, but also about effectiveness" Comey said at the National Organization of Black Law Enforcement Executives annual meeting last March. "It's about being good at what we do. We are simply less effective when we are less diverse."

The earliest Asian agents largely dismiss the descriptive modifier in their title—much as the first women agents

did in 1972. Like his colleagues, Joe Louie, the third known Asian to be hired as an agent in 1966, just wanted to be called an agent—period. "I don't think they really cared if you were black, white, or purple," he said. "If you were selected for being an agent, that was a prime job."

Frederick Wong's career, from 1982 to 2007, may best illustrate the point. He was one of Chris Loo's hires who went on to become a legal attaché, not once but twice. His first overseas office was in Belgium. "I remember some of my colleagues in Belgium, the Netherlands, and Luxembourg, they were quite surprised, but pleasantly surprised that 'you aren't all white agents,'" he said. "It was a big plus. It helped me open doors."

A Name You Already Know And Trust Just Got Even More Dependable
DEPENDABLE AUTO SERVICE, LUBE AND TIRES
is Now Offering
Expert, Affordable Transmission Service
All ASE Certified Technicians

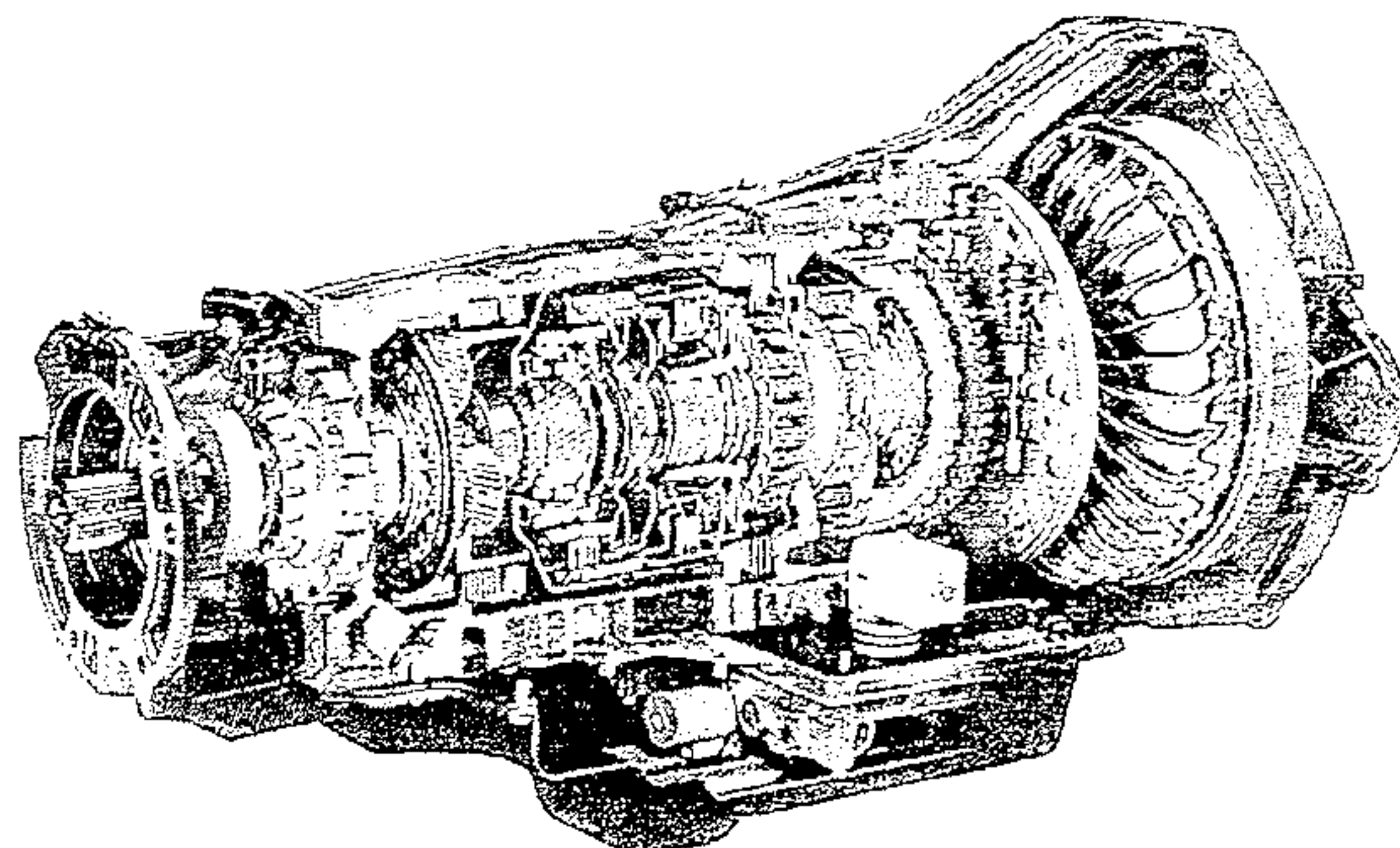

We proudly welcome all New Customers and Former Advanced Transmission Customers with a 10% Discount and Any Transmission Service or Repair*

865-986-9359

865-986-5050

Bad Credit, No Credit OK!!! We Finance Everybody!!!

Low Down Payment!!!

Over 100 Cars, Trucks & Vans in Stock - Warranties On ALL Vehicles Sold!!!

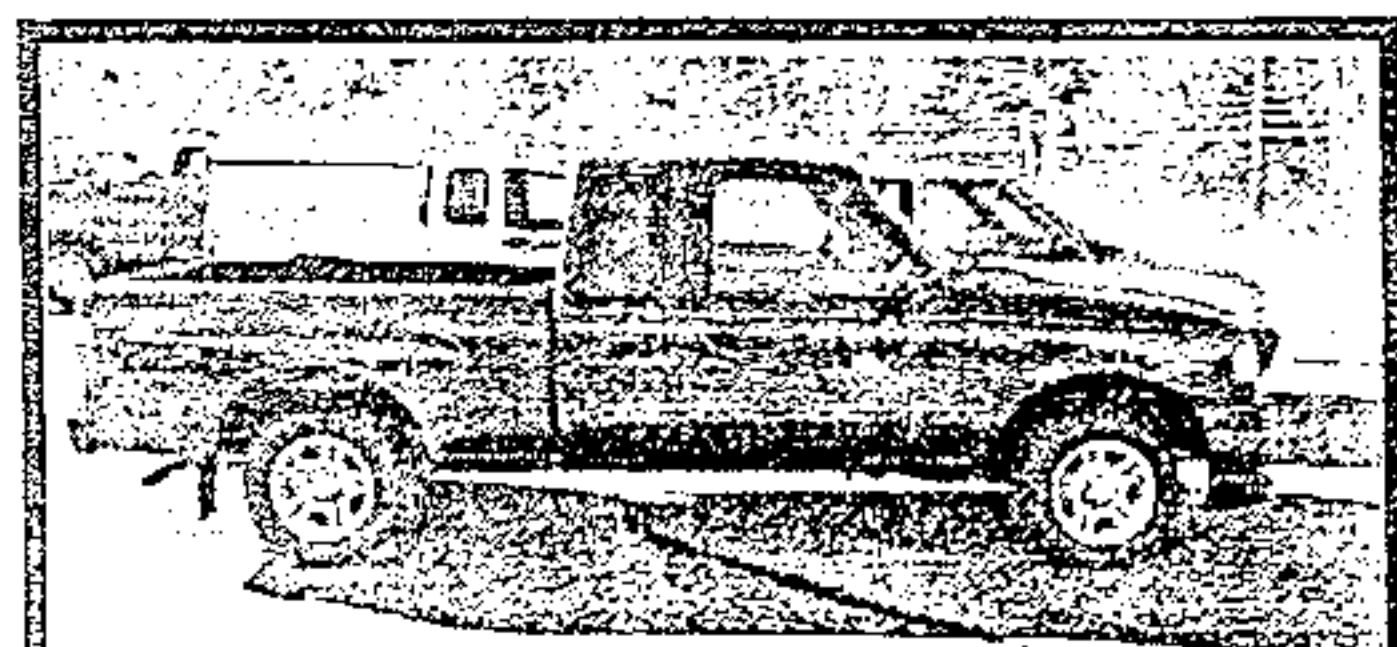

2005 Ford Ranger, Super Nice Truck, Very Low Miles



2009 Nissan Cube, Great Gas Saver, Clean



2009 Saturn Vue, Nice Ride, clean ready to roll!

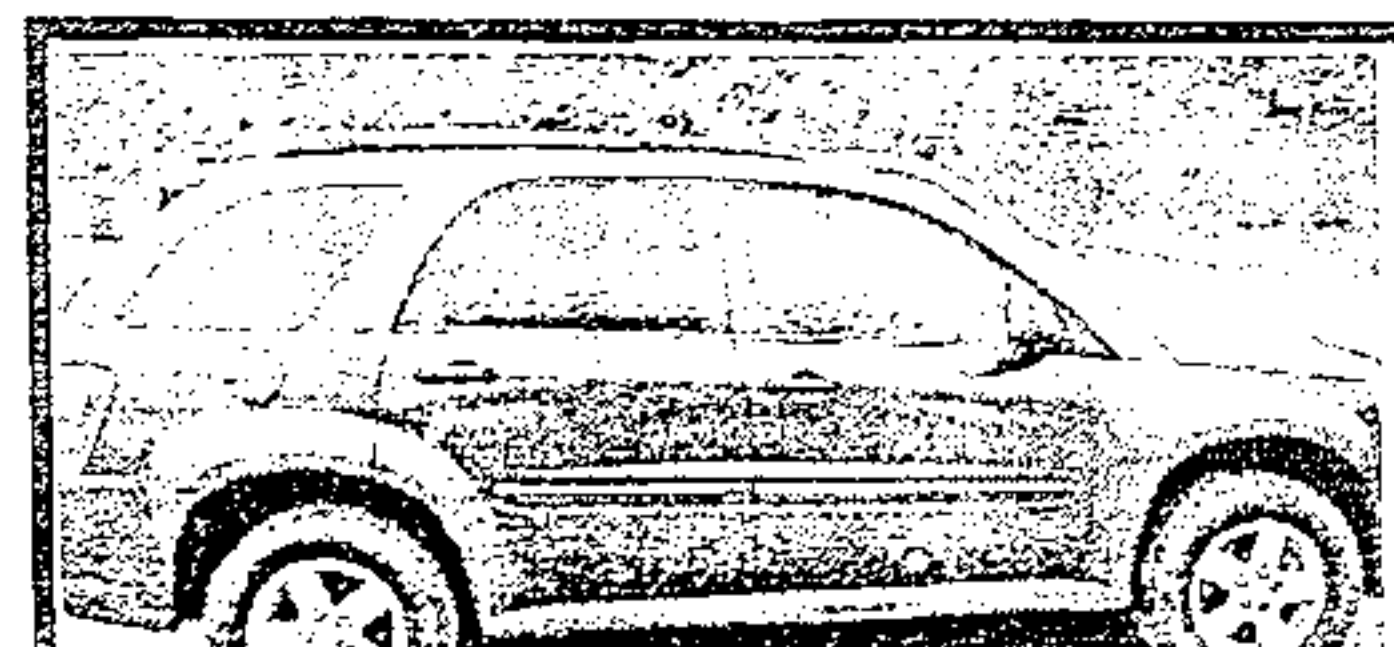

2007 Chevy Equinox, 4dr, Extra Clean, lots of room

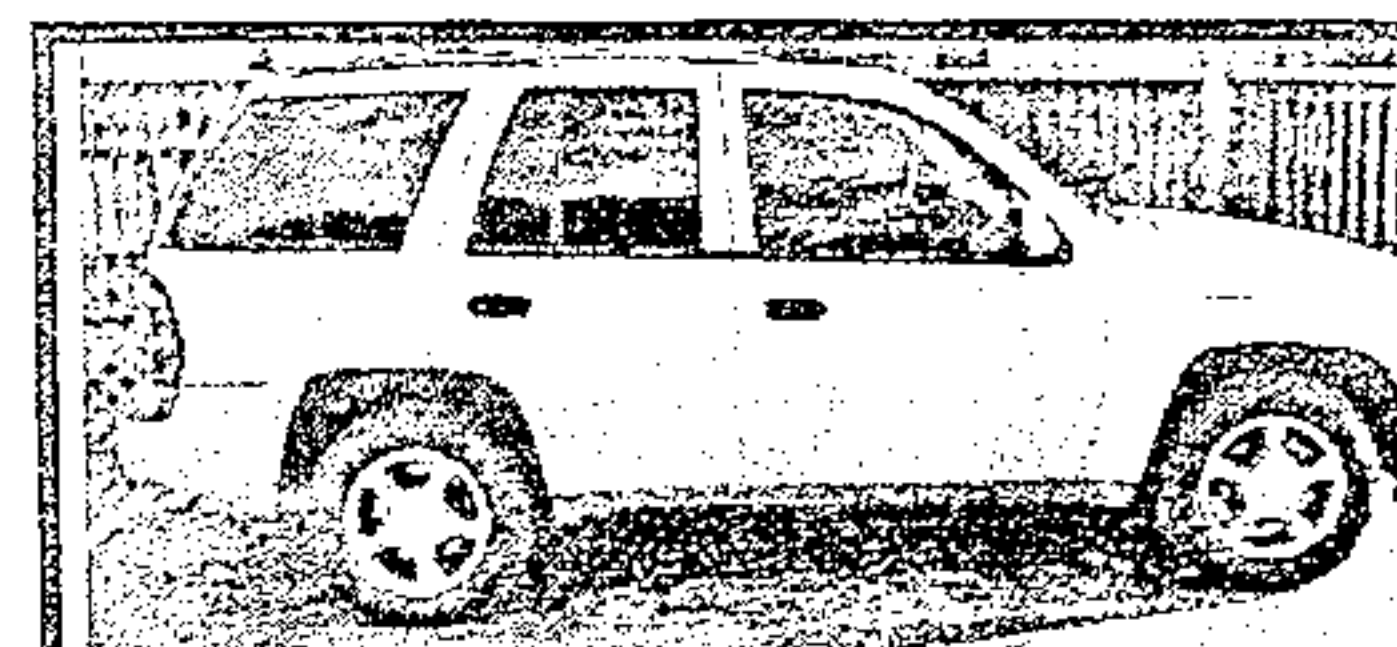

2008 Chevy Trailblazer, NICE! Loaded

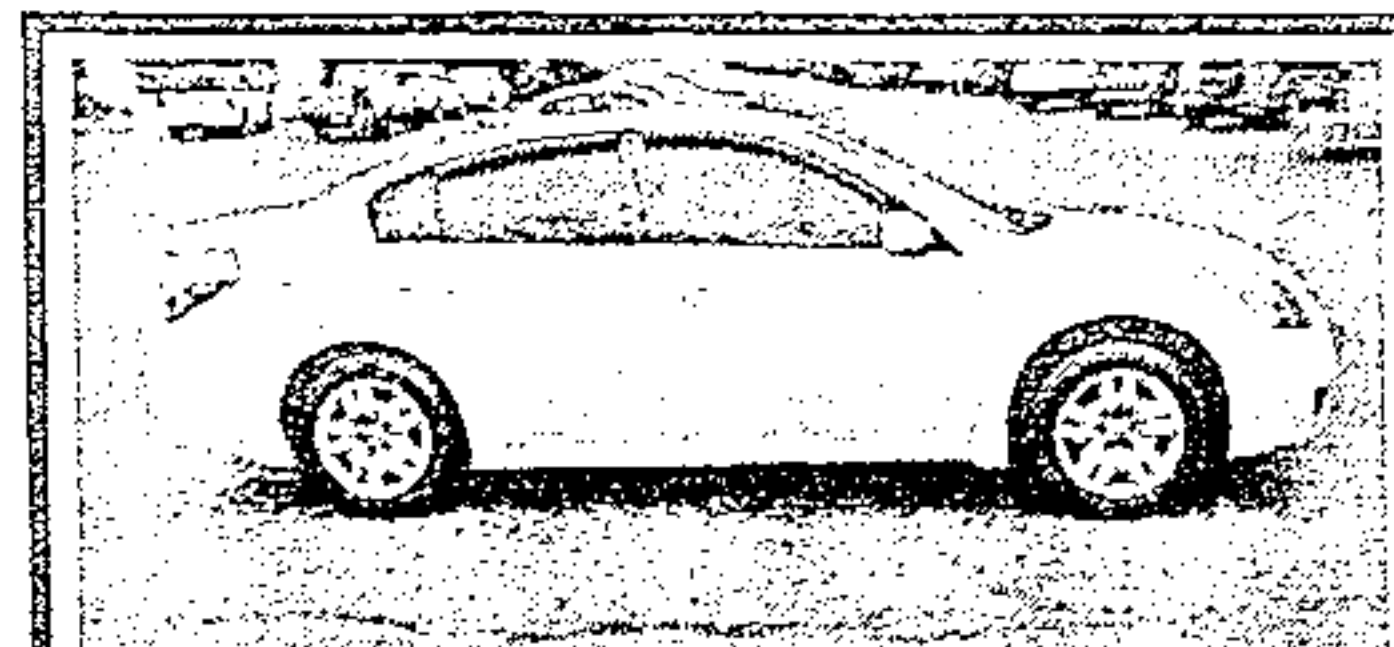

2009 Nissan Altima, LOADED, Super Nice Sporty Ride

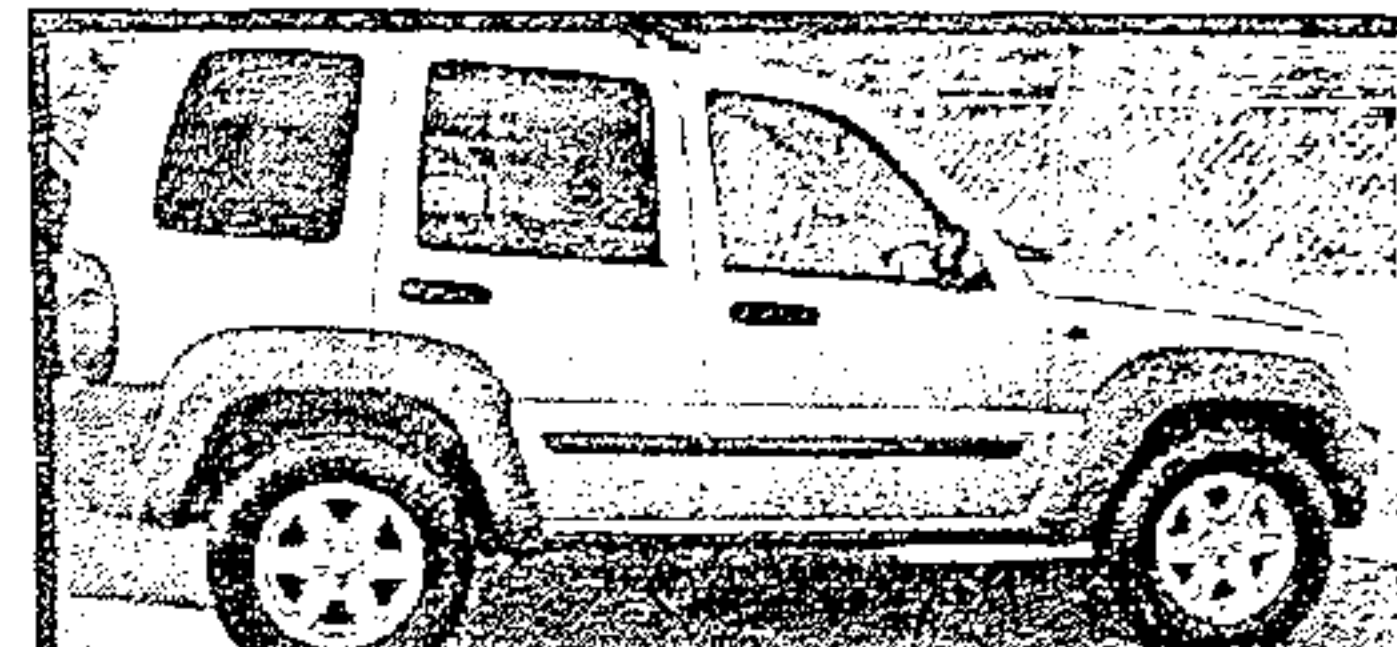

2004 Jeep Liberty, Nice, Extra Clean

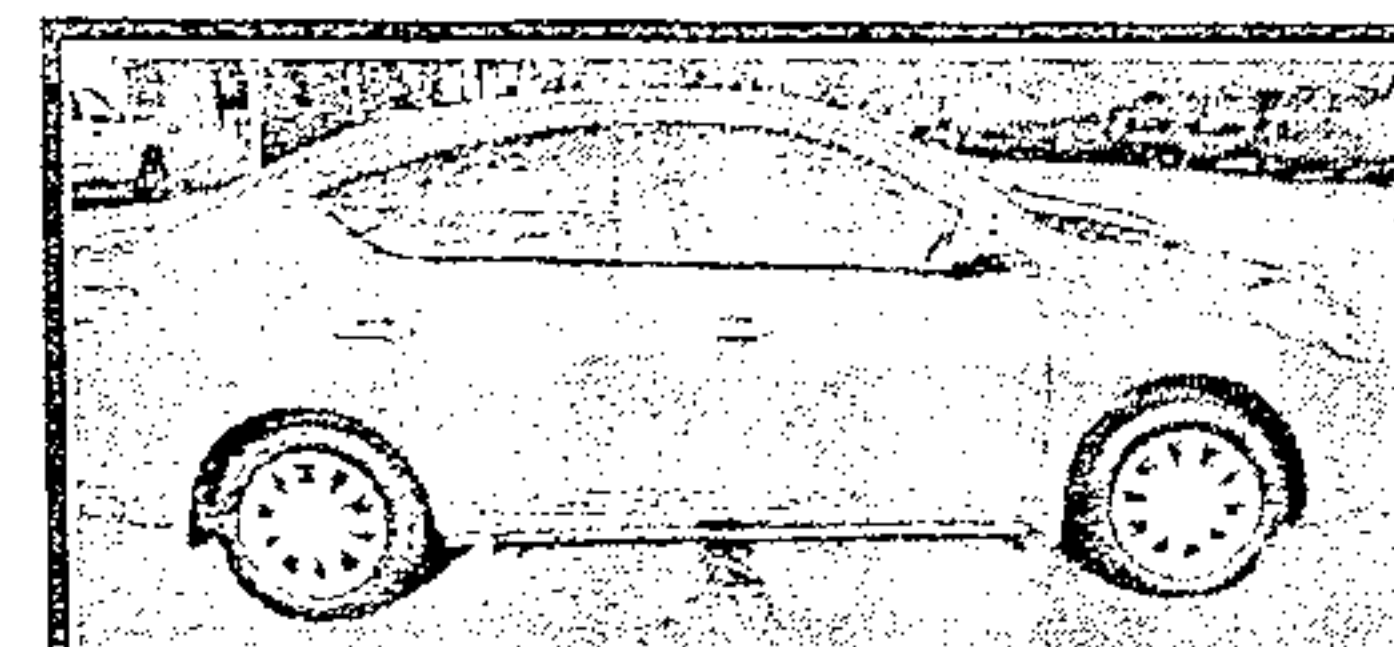

2013 Nissan Versa, Like New! LOADED!!!

WALT WILLIAMS, INC.

*with approved credit

3003 Highway 11 Lenoir City, TN 865-986-1111