

# The Daily Edition

50¢

Serving Loudon, Monroe and Surrounding Counties

Thursday, November 26, 2015

First to report assault is the one who gets charged



Nicholas Tackett  
(see DV pg. 3)

## Pills and syringes found on wanted woman



Jessica Bahr (see wanted pg. 2)

## Ten individuals sentenced in stolen identity tax refund scheme

Ten individuals indicted in February 2015 for conspiracy to commit wire fraud, theft of public money and money laundering conspiracy, have all been convicted and sentenced.

Eugene Carl Kotelman, 39, of Burtchville, Mich. was sentenced on Oct. 22, 2015, to serve 55 months in federal prison to run consecutively with any state sentence. Upon

his release from prison, he will serve a term of three years supervised release.

Jamie Marie Lowery, 38, of Port Huron, Mich., was sentenced on Oct 10, 2015, to serve 27 months in federal prison to run consecutively with any state sentence. Upon her release from prison, she will serve a term of three years supervised release.

(see scheme pg. 5)

## Passed out drunk, no license, and then wants to fight

Jose Vasquez-Herandez, 30, Avery Street Lenoir City, was charged with DUI, Driving without a valid License, and Vandalism. Deputy Jamie Ketner LCSO, was dispatched to Avery Street on a suspicious vehicle. Upon arrival Deputy observed a Hispanic male in the driver seat passed out, with the vehicle run-

(see DUI+ pg. 7)

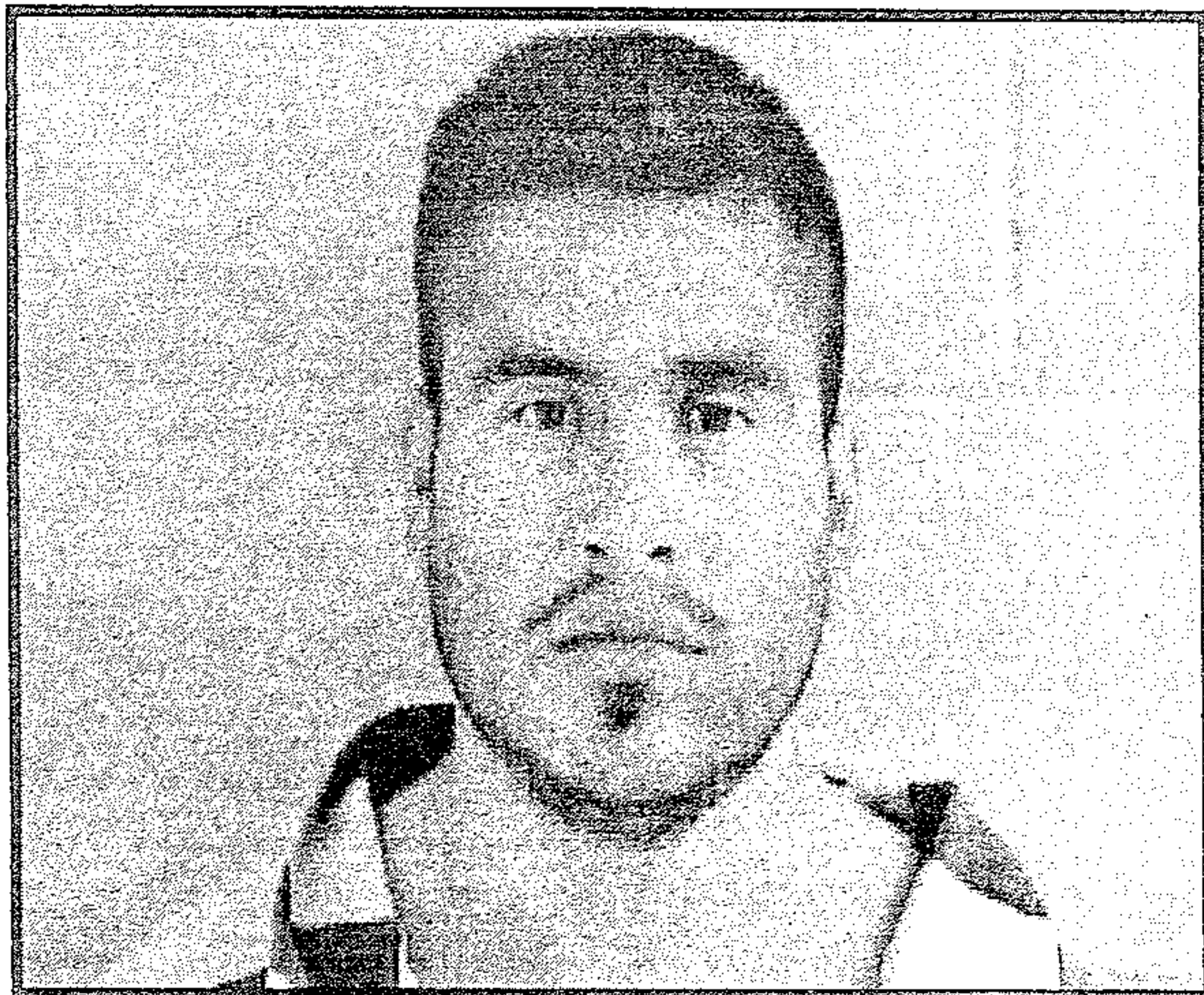

Jose Vasquez-Herandez

## Daniel Sands arrested and charged with retaliation against a federal witness

Facebook used to make threats

On Nov. 20, 2015, Daniel Sands was arrested and charged in a criminal complaint with engaging in conduct with the intent to retaliate against a witness who testified against his father in an official court proceeding in U.S. District Court.

An initial appearance was held this afternoon before the Honorable H. Bruce Guyton, U.S. Magistrate Judge, at which

time the government asked that Sands be detained pending trial on the charge against him. Sands agreed to sign a detention hearing waiver and will remain in custody until a preliminary hearing scheduled for 2:30 p.m., on Dec. 2, 2015, in U.S. District Court.

According to the complaint and accompanying affidavit on file with the U.S. District Court, on Nov. 17,

(see Sands pg. 4)

### Verse of the Day

Satisfy us in the morning with your unfailing love, that we may sing for joy and be glad all our days. — Psalm 90:14

### Obituaries

see inside **Wazzup**  
Happy Thanksgiving From All of Us Here at The Daily Edition! Be sure to be safe out there on Black Friday!

### Weather

Today: Mostly sunny skies. High near 65F.  
Tonight: Mainly clear skies. Areas of dense fog developing. Low 43F.  
Friday: Partly cloudy skies. High 67F.  
Friday Night: Mainly

cloudy. Low 47F.

### Horoscopes

Scorpio 10/23-11/21

Your mind is hyperactive with so many thoughts today that you can't discern the useful ones from the superfluous noise. It's

(Continued on page 6)

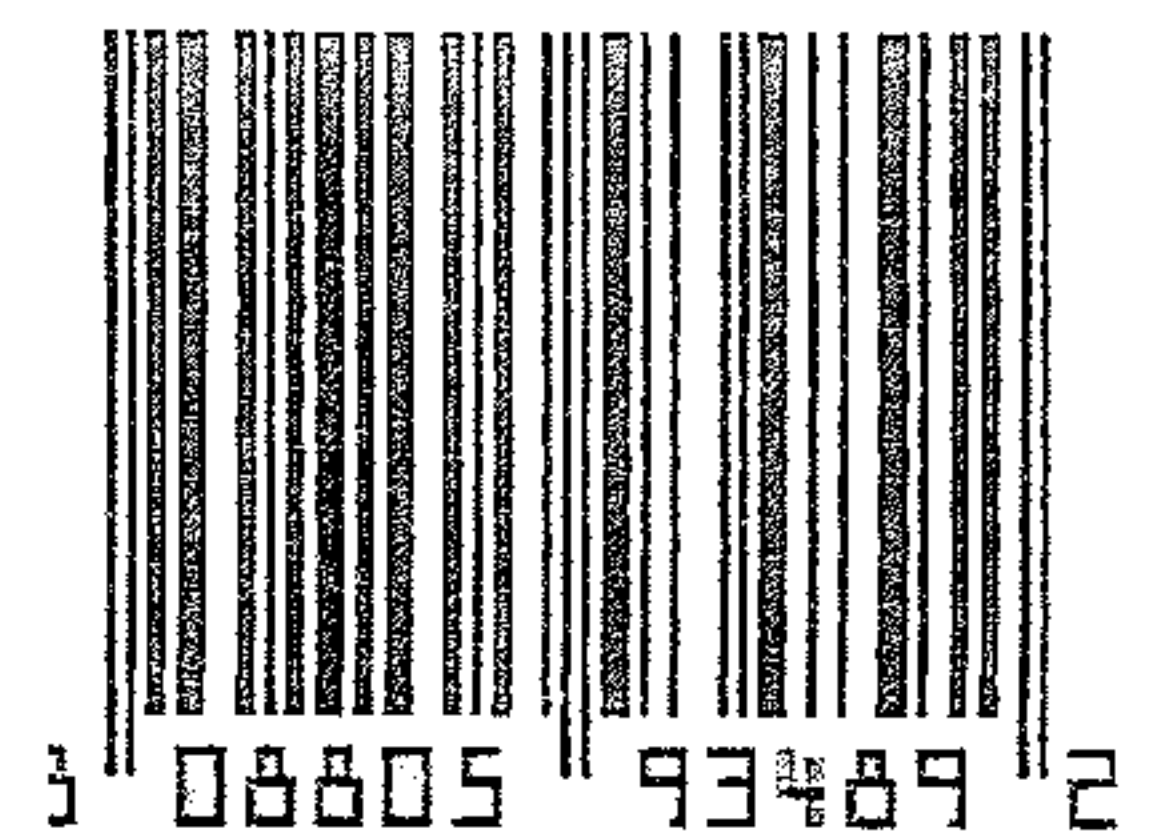

wanted

Jessica Bahr, 33, McCrary Street Philadelphia, was charged with Simple Possession x2, Driving on Revoked License, Poss. of Drug Para., and Failure to Appear. Deputy Cody Fritts LCSO, observed a white vehicle traveling on Christian Street, and recognized the driver as Jessica Bahr. Deputy had prior knowl-

edge Jessica had outstanding Warrants out of Loudon Co. Deputy stopped the vehicle at Christian St & Thompson St. Jessica was placed under arrest and ask if she had anything illegal in the vehicle Jessica stated she had Hydrocodone in her purse. After searching Deputy found Hydrocodone and a Suboxone Strip, and two syringes. Deputy Cody Fritts LCSO, made the arrest.

**Call 865-771-2249 to Advertise and start saving today!**  
**Has your group got an event coming up?**  
**Let us know!!!**

**Notice**  
 Vin 1G82557N87F202859  
 General Motors Vehicle will be sold. If anyone has a lien on this vehicle contact: Homer's Body Shop, 10609 Beals Chapel Road, Lenoir City, 37772, 865-388-0372.

Notice: The Daily Edition does not knowingly accept fraudulent or misleading materials. The Daily Edition cannot guarantee the validity of offerings or statements contained herein. All liability for the contents of all advertising, and for any claims that may arise therefrom, is the responsibility of the advertiser or its agency. The Daily Edition reserves the right to reject, edit, or abbreviate any advertisement submitted. Advertising is accepted with the understanding that all liability for all copyright violations is the sole responsibility of the advertiser. Photographs, artwork and other copy submitted for publication is considered the sole property of the advertiser. The Daily Edition will make every effort but will not be liable for failure to publish and ad or for typographical and layout errors. All statements and information about highlights featured items, letters to the editor, herein are those solely given to the interviewer or writer and the Daily Edition assumes no responsibility of the accuracy or validity thereof. The Daily Edition will gladly reprint at no charge that part of an advertisement in which an error occurs provided a claim is made within 3 days of the first publication of the ad. Information contained in the Wazzup is received anonymously and the Daily Edition assumes no responsibility for information and reserves the right to edit or reject any and/or all submissions. The Daily Edition is a daily newspaper of general circulation in Loudon County defined under TCA 2-1-104(a)(13). The Daily Edition also serves Monroe, Knox, Anderson, Roane and Blount counties and serves 30,000 readers weekly. Send mail to PO Box 1240, Lenoir City TN 37771. 865-771-2249. email: dan1204us@yahoo.com  
 The Daily Edition is Loudon County's premier public interest and paid advertising paper. The Daily Edition is produced and published daily Monday through Friday and is circulated throughout Loudon County and parts of Monroe and Knox Counties. Display advertising rates \$5.00 per column inch and quantity discounts available. Call for information on upcoming promotions and events.

**HACIENDA Ayala's**  
**Mexican Restaurant**  
 Market Dr. \* Lenoir City (In Front of Food City)

**Real Authentic Mexican Food at Affordable Prices**

**BEST MARGARITA**

You've Tried The Rest  
 Now Come Have The Best!!!

We Accept ALL Competitors Coupons Outside of Mexico City!

986-3553



**Good Credit OK • Bad Credit OK • Bankruptcies OK • Repo OK**



2010 Kia Soul Sporty, 4 cyl, Auto, PW, PL, A/C, Great On Gas, Like New



2010 Ford Escape Limited Leather, Alloy Wheels, Heat, A/C, Luggage Rack, 79K,



2007 Dodge Ram 1500 Quad Cab, Thunder Road PKG, 20 in. Wheels, Low Miles, Hemi



2008 Ford Explorer 84k, 3rd Row Seating, Luggage Rack, Tow Pkg, PW, PL



2011 Ford Ranger Low Miles, Tow Pkg, New Tires, A/C, Heat, Bed Liner.



2011 Dodge Grand Caravan DVD, Stow & Go, Loaded, Remote Doors, Rear A/C

**DEPENDABLE MOTORS 986-9343**  
**803 E. Broadway • Lenoir City**

*Serving Loudon County for 20 Years*

\* WAC. See Dealer for details

Visit our website at: [www.dependablemotorslc.com](http://www.dependablemotorslc.com)

DV

Nicholas Tackett, 27, West Lee Hwy Loudon, was charged with Domestic Assault.

According to the report, Nicholas Ray Tackett came to the Loudon Police Department and reported to Officer G.W. Kerley his sister and girlfriend (two different subjects) did physically assault him during an argument that was occurring between he and his girlfriend at Pathkiller Trail in Loudon.

Statements were also taken from witnesses and the victim which also came to Loudon Police Department to report the incident.

After extensive evaluation of the statements obtained from all parties involved it was determined Nicholas Ray Tackett was the primary aggressor and was therefore charged and transported to the Loudon County Justice Center. Officer G.W. Kerley, LPD made the arrest.

Obituaries

Joseph E. Klint III (Bud), age 76 of the Tellico Village Community passed away November 23, 2015. Born November 19, 1939 in Joliet, IL to Joseph E. Klint II and Berta Isberg Klint. He graduated from Joliet Township High School and Aurora University. Joe was a member of The Community Church at Tellico Village where he was the founder of the Tellico Joe Caf . Joe was also a member of

St. John Lutheran Church in Joliet, IL. He was the founder and charter president of the Tellico Village Lions Club and a 42 year Lion earning a Melvin Jones. Joe was always very active in community service everywhere he lived including work with the American Cancer Society, Sheltered Workshop, and church work. Survivors include his wife of 50 years, Kay Zusag Klint; son Joseph Michael Klint (Melanie) and daughter Susan Redfield (Charles); grandchildren Avery and Matthew Redfield and Alexandra and Ham-

ilton Klint; sisters Kay Jevitz and Susan Costigan (Michael); niece Katy Hagman (Bill) and nephew John Jevitz. A Celebration of Life Service will be held on Saturday, November 28, 2015 at 11 a.m. in the Founders Chapel at The Community Church at Tellico Village. The family will receive friends immediately following the service. In lieu of flowers, memorials may be made to The Community Church at Tellico Village, St. John Lutheran Church in Joliet, IL. or to the Lions Club.

**For Sale: Oak Wood Mulch**



Mushroom Compost Topsoil.



Firewood

Call Steve Spoon  
986-4282

**West End Storage & Warehouses**  
502 Ward Avenue • Loudon  
Call 865-458-4774 or 865-679-5555



**C&C Lawn Care**  
Mowing, Mulching, Trimming, Edging, Clear Debris  
Free Estimates  
Call Chad 865-271-8070

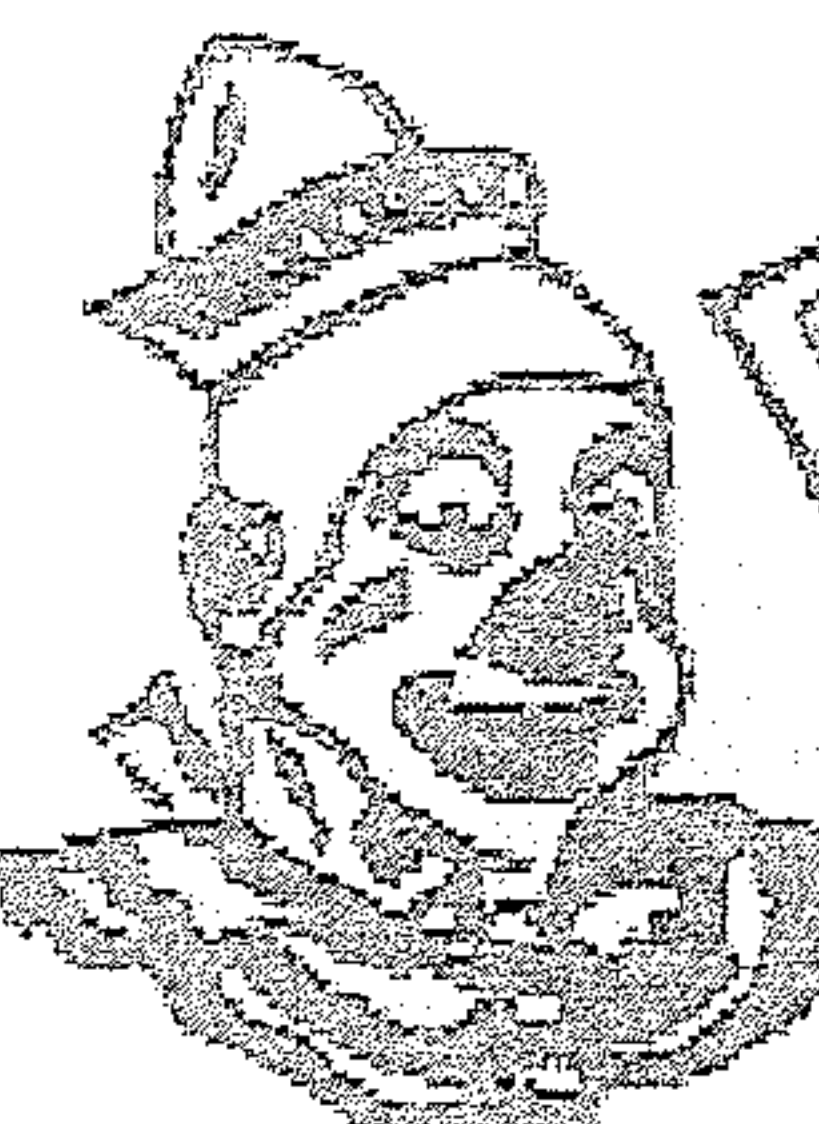

**BIMBO'S**  
Deli Open 24 Hours  
865-986-9643 Call Ins Welcome  
Specials  
Lg. Cold Sub, bag of chips and 16 oz. fountain drink only \$6.29  
Footlong Corn Dog \$2.59

**C&J Towing and Recovery**  
LOWEST TOWING RATES AROUND!!!

Have you been overcharged for any type of towing service in the Lenoir City area? If you have a breakdown or accident please OWNER REQUEST C&J Towing with the officer. Also please call your Sheriff and ask him to place C&J Towing on the "Rotation List\*" and help other motorists save as much as you did! We at C&J are locally owned and operated, State approved, licensed, bonded and insured. Call and let us know if your denied service or how we can be of assistance.

\*note: the "Rotation List" is a list of wrecker services that provide service for wrecks, DUI's, breakdowns, etc. and are on an on-call basis for service. This list is approved by the Sheriff.

Cliff Teeters • Owner  
865-809-1661



Sands

2015, the government called David Walker as a witness to testify in the trial of U.S. v. Leonard Sands, in U.S. District Court in Knoxville. It is alleged that on that same evening, Daniel Sands, son of the defendant Leonard Sands, sent a threatening instant message to the witness via Facebook messenger. The affidavit further alleges that on Nov. 19, 2015, Daniel Sands posted other indirect threats of violence to "snitches" on his Facebook page. Details of the four Facebook posts are included in the affidavit and attachments thereto.

The investigation in this case is being led by the Drug Enforce-

ment Administration and Tennessee Bureau of Investigation. Assistant U.S. Attorneys Cynthia Davidson and Jennifer Kolman represent the United States.

Members of the public are reminded that a complaint constitutes only a charge and that every person is presumed innocent un-

til his or her guilt has been proven beyond a reasonable doubt.

Loudon County Sheriff's Office Toys for Tots 2015

Thanks to the generosity year after year of the Loudon County residents, churches, businesses and industries, the Loudon County Sheriff's Office is once

again able to offer the Toys for Tots program. We are beginning our 31st year of providing toys to the needy children of Loudon County, and thanks to generous contributions of time, money and gifts, we are able to make Christmas a more joyful time for more and

more children. In 2014, approximately 500 children were helped by the Loudon County Sheriff's Department Toys for Tots program through their partners. Even with the difficult economic times we are experiencing, we hope that the people (see T4T ctd. pg. 7)

**SARCO Enterprises Inc. Offers Complete Home and Commercial Remolding and Repairs**

Our Team members have a combined total of over 40 years experience in all areas of home construction, facilities maintenance and commercial construction. Roofing, Electrical, Bath and Kitchen Renovations, we do it all with just one call. We are fully insured and our work is guaranteed.

Call us today for a free no obligation quote for your next project. 865-809-9492.

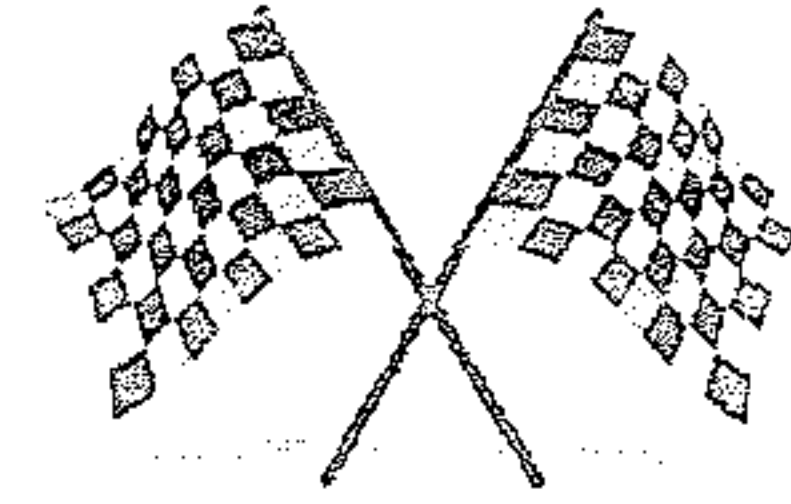

**SOUTHERN AUTO DETAILING**

**414 WEST BROADWAY**

**LENOIR CITY, TN 37771**

**865-986-0724**

**Starting at \$34.95**

**Present this ad for \$5.00 off**

**BUDGET**  
*Transmissions*

**Why Buy From Budget?**

**Free Towing From Lenoir City or Loudon County**  
**20 Years of BBB Zero Customer Complaints Award Member**

**A+ Plus Rated**  
**Huge Transmission Inventory**  
**Best Technicians Period!!!**

**Call (865) 584-4391 Today!**

**302 S. Northshore Drive Knoxville**

**(865) 584-4391**

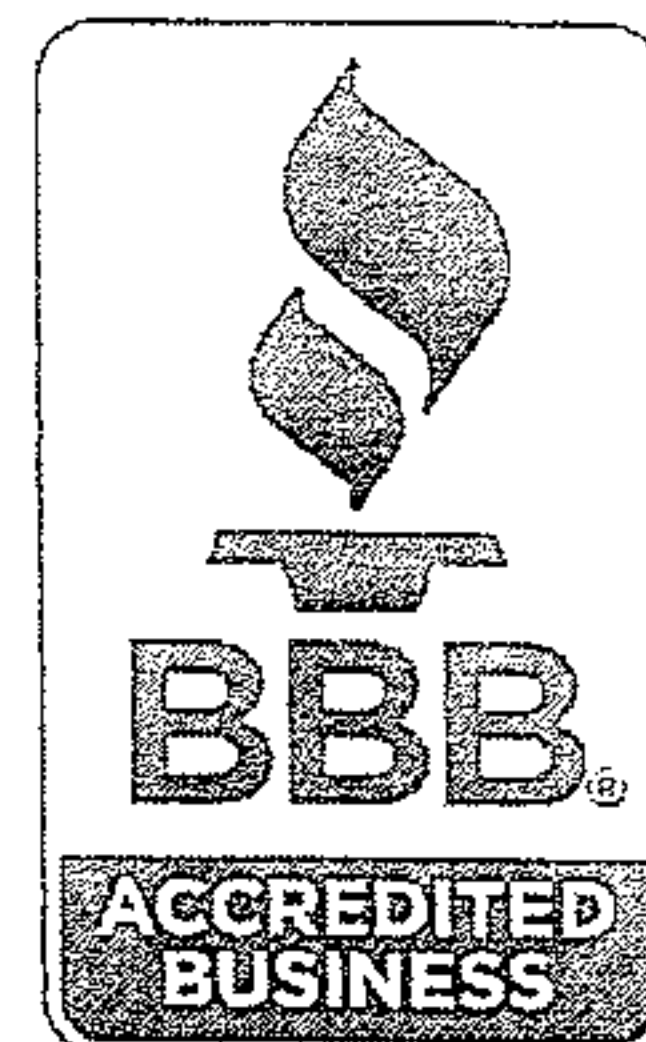
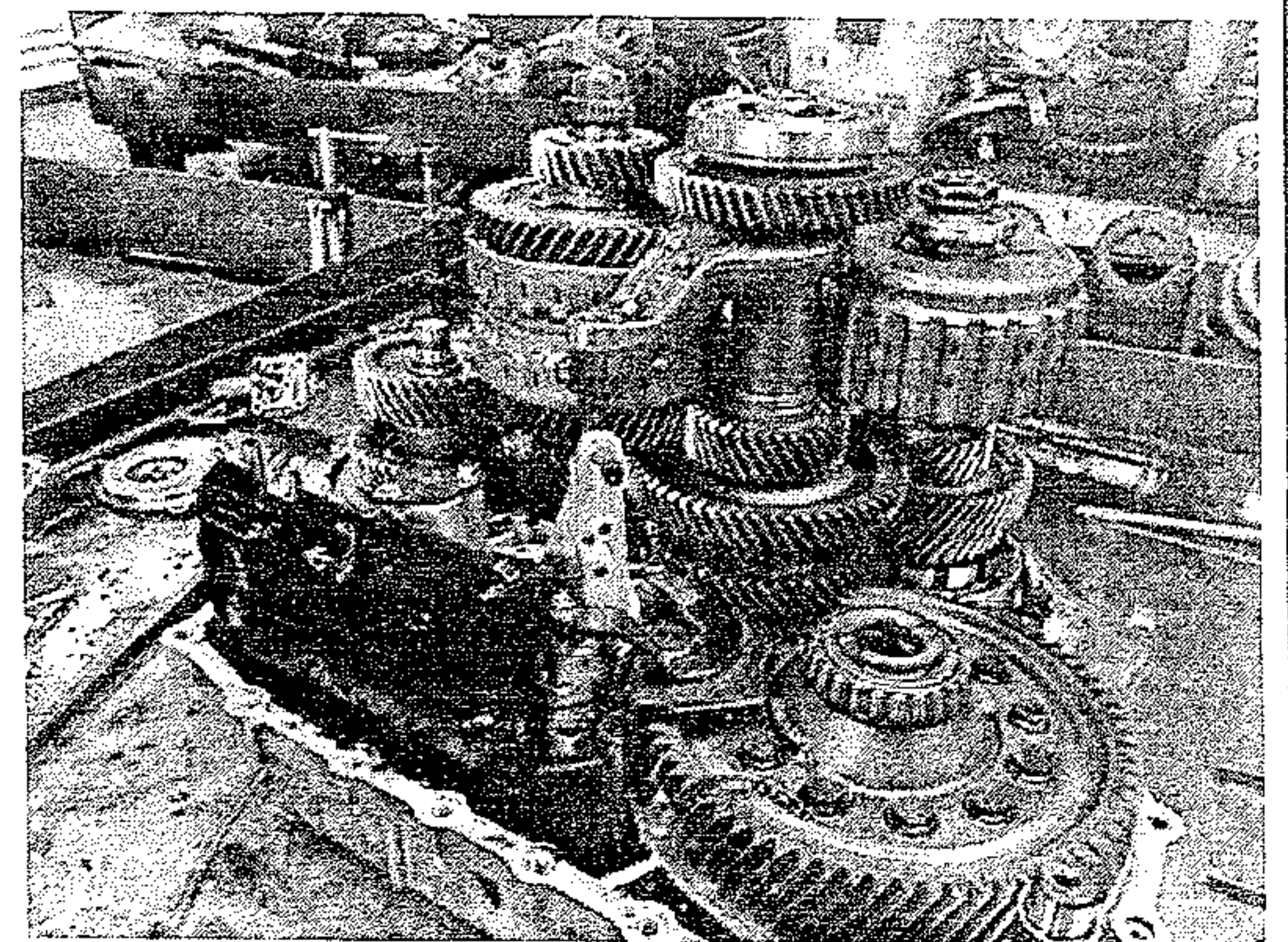

*budget-transmissions.com*



**Approved Auto Repair**



**scheme**

Brian Keith Elliott, 49, of Greeneville, Tenn., was sentenced on Oct. 8, 2015, to serve 27 months in federal prison consecutively to any state sentence. Upon his release from prison, he will serve a term of three years supervised release.

Bernard Erwin Goewey, 47, of Afton, Tenn., was sentenced on Aug 11, 2015, to serve three years of

probation.

Michelle Goewey, 44, of Afton, Tenn., was sentenced on Aug. 11, 2015, to serve a total of six months in prison, followed by a term of six month home detention. Upon her release from prison, she will serve three years of supervised release.

Timothy Ray Groh, 46, of Port Huron, Mich., was sentenced on Oct. 6, 2015, to serve to serve 27 months in

federal prison. Upon his release from prison, he will serve a term of three years supervised release.

Jake Marshall McKelvey, 53, of Atlanta, Mich., was sentenced on Oct. 8, 2015, to serve 27 months in prison to run consecutive with any sentence received in state court. Upon his release from prison, he will serve three years supervised release.

Gerald Kenneth Or-

shal, III, 56, of Crystal River, Fla., was sentenced on Nov. 19, 2015, to serve 12 months in prison. Upon his release from prison, he will serve three years on supervised release.

Amy Rose Peters Thompson, 33, Port Huron, Mich., was sentenced on Nov. 19, 2015, to serve 15 months in federal prison. Upon her release from prison, she will serve three years of su-

pervised release.

Terri Lynn Worley, 52, of Port Huron, Mich., was sentenced on Oct. 6, 2015, to serve 24 months in prison and three years of supervised release upon her release from prison.

Each defendant was ordered to pay restitution to the United States in the amount of \$1,249,934.00, which they owe jointly and severally. Each defendant was ordered to pay a special assessment of \$100.

Between January 2008 and December 2012, these individuals conspired to obtain money from the Internal Revenue Service (IRS) by submitting fraudulent federal income tax returns that claimed false federal income tax refunds. As part of the scheme, they submitted, or caused to be submitted, a total of 150 federal income tax returns claiming false tax refunds of \$1.2 million. The false returns were filed using stolen Personal Identification Information (PII) of others which was used without the individual's authorization.

U.S. Attorney Bill Killian said, "The U.S. Attorney's Office will continue to prosecute these types of offenders. Collectively, these 10 individuals will serve 220 months in federal prison. This sends a message to others who may consider committing identity theft and tax fraud against innocent taxpayers that they are facing serious penalties for their actions."

"Individuals who commit identity theft and refund fraud of

(see scheme ctd., pg. 8)

**PURDY'S AUTO PARTS AND SALVAGE**  
**WE BUY SCRAP IRON • COPPER • BRASS • ALUMINUM**

**\$** **Paying Top \$\$\$**  
**Call For Latest Prices**

*You Name It, We Buy It!*

*Radiators, Wheels, Batteries, Appliances, Farm Equipment*

**Copper**  
**Paying Top \$\$\$**  
**Call For Latest Prices**

**Complete Cars**  
**per 100 lbs.**

**Scrap Metal**  
**Paying Top \$\$\$**  
**Call For Latest Prices**  
**per 100 lb**

**We Buy Batteries**

**Aluminum Cans**  
**Paying Top \$\$\$**  
**Call For Latest Prices**

**Now Selling**  
**Aftermarket**  
**Body Parts at**  
**Discount Prices**

**You Call We Haul!**  
**423-519-5402**



Prices subject to change with the market.

**423 337-3977**  
**149 County Road 323 Sweetwater**

Prices subject to change with the market.

attack  
 ning, and the gear in neutral, and his foot on the brake. After several attempts Deputy woke the subject up and identified him as Jose Vasquez. Jose had a strong odor of alcoholic beverage on his person. Jose had hit 2 vehicle and caused damage to both vehicles. Jose about fell asleep during sobriety test. Jose was placed under arrest. On the way to jail Jose vomited on himself in back of the patrol vehicle, Deputy stopped the vehicle and removed Jose and called for an ambulance. Deputy cleared Jose airway

and Jose became responsive. EMS arrived on scene and became very aggressive towards Deputy and Paramedics. Cpl. Kevin Kirkland had to dry stun Jose. Jose was transported to FT. Loudon ER for treatment. Deputy Jamie Ketner LCSO, made the arrest.

T4T ctd. from pg. 4

of Loudon County will be there once again to help.

If your business or church would be willing to take names please call Debbie Hines, Toys for Tots Coordinator at 986-4823.

Names are available

through business and churches. If you are considering helping a child this Christmas, please be assured that applicants are thoroughly checked to make sure they require this assistance. Names are also compared with the school systems to make sure no one is receiving duplicate assistance.

**Police beat**

Casey Elmore,34, Crystal Lane Oliver Springs, was charged with Violation of Probation. Deputy Chad Purdy LCSO, served a VOP Warrant on Casey at the Loudon Co. Jail

Jason King,44,Army Street Knoxville, was

charged with Contempt of Court. Cpl. David Bearden LCSO, served a Contempt Warrant on Jason at the Loudon Co. Jail.

Natasha Manis,28, Kelly Lane Lenoir City, was charged with Failure to Appear. Deputy Olwin Norman LCSO, served a FTA Warrant on Natasha at the Loudon Co. Jail.

Courtney Crass,28, Abbott road Lenoir Jail

City, was charged with Driving on Revoked License. Officer Dennis Guider LCPD, arrested Courtney at Hwy 321@ Loves for driving on revoked license.

Heath Yearwood,44, Fagin Road Vonore, was charged with Criminal Court Capias. Deputy Chance Gray LCSO, served a CC Capias Warrant on Heath at the Loudon

**Is Your Washer Broken?**

Call Me

I Only Charge \$100 Period!!!

Call Allen

865-617-7113

**LOOK!**

**\$75 Weekly Payments**

**LOOK!**

MARTY'S AUTO SALES • 986-2222 • MARTY'S AUTO SALES • 986-2222 • MARTY'S AUTO SALES • 986-2222 • MARTY'S AUTO SALES • 986-2222 • MARTY'S AUTO SALES •

Bad Credit  
 Divorce  
 Fixed Income  
 Repos  
 Bankruptcy  
 No Credit

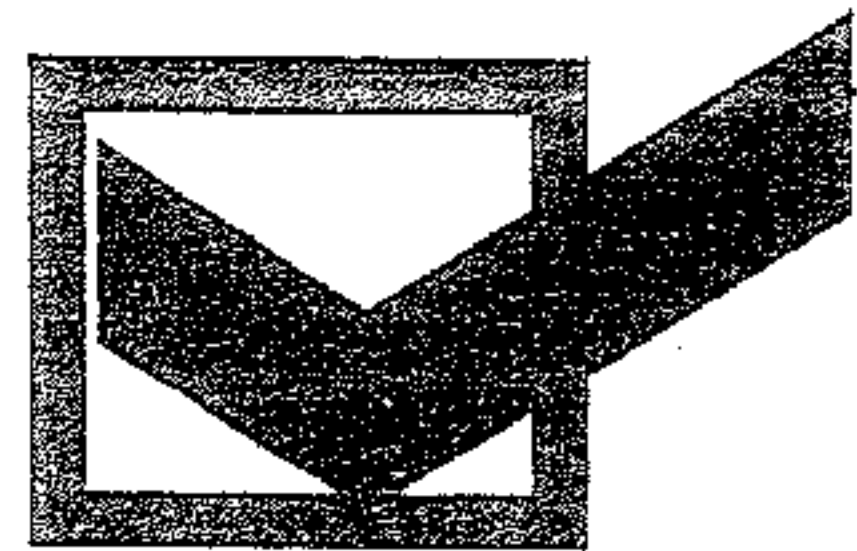

**APPROVED!**

Visit Us On The Web At:  
[marty'sautosales.net](http://marty'sautosales.net)

**NO CREDIT CHECKS**

\$499 down\*  
  
 07 Cobalt, 5spd, gas saver, runs great Only \$499 down\*

\$499 down\*  
  
 02 Sable, sunroof, loaded, Only \$499 down\*

\$499 down\*  
  
 04 Cavalier, 2dr, Sporty, Only \$499 down\*

\$499 down\*  
  
 01 Sebring 2dr. sporty, Only \$499 down\*

\$299 down\*  
  
 97 Escort, auto, Gas Saver, Only \$299 down\*

\$499 down\*  
  
 99 Deville, Loaded, Luxury, Nice Only \$499 down\*

\$399 down\*  
  
 99 Corolla, auto, Gas Saver, Only \$399 down\*

\$499 down\*  
  
 00 Ram, High Top Conversion Van, Loaded only \$499 down\*

**NO Credit Checks**

**Marty's Auto Sales**  
 986-2222

Se Habla Espanol

**100% Approval\***

\*See Dealer for details. All down payments plus tax, tag, title and fees.

MARTY'S AUTO SALES • 986-2222 • MARTY'S AUTO SALES • 986-2222 • MARTY'S AUTO SALES • 986-2222 • MARTY'S AUTO SALES • 986-2222 • MARTY'S AUTO SALES •

scheme etd. from pg. 5  
 this magnitude deserve to be punished to the fullest extent of the law," said Tamera Cantu, Acting Special Agent in Charge. "These individuals demonstrated a blatant disregard for the integrity of the United States tax system and caused immeasurable hardship to innocent victims. IRS Criminal Investigation remains

committed to the pursuit of identity theft, and together with our partners at the U.S. Attorney's Office, we will hold those who engage in similar conduct accountable."

The case was investigated by Special Agents with the IRS-Criminal Investigation. Assistant U.S. Attorney Helen Smith represents the United States.

**LONNIE JONES  
 OPTICAL DISPENSARY**

"We Make The Difference You Can See"  
 Locally Owned and Operated

Over 1000 Frames To Choose From  
 No Frame Over \$69.00

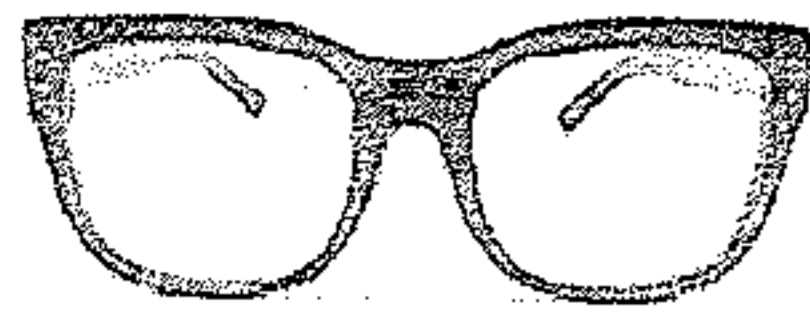

On the corner of A & Depot Street, Lenoir City

**986-7803**

Serving Loudon County for over 40 years

**A Name You Already Know And Trust Just Got Even More Dependable  
 DEPENDABLE AUTO SERVICE, LUBE AND TIRES  
 is Now Offering  
 Expert, Affordable Transmission Service**

All ASE Certified Technicians

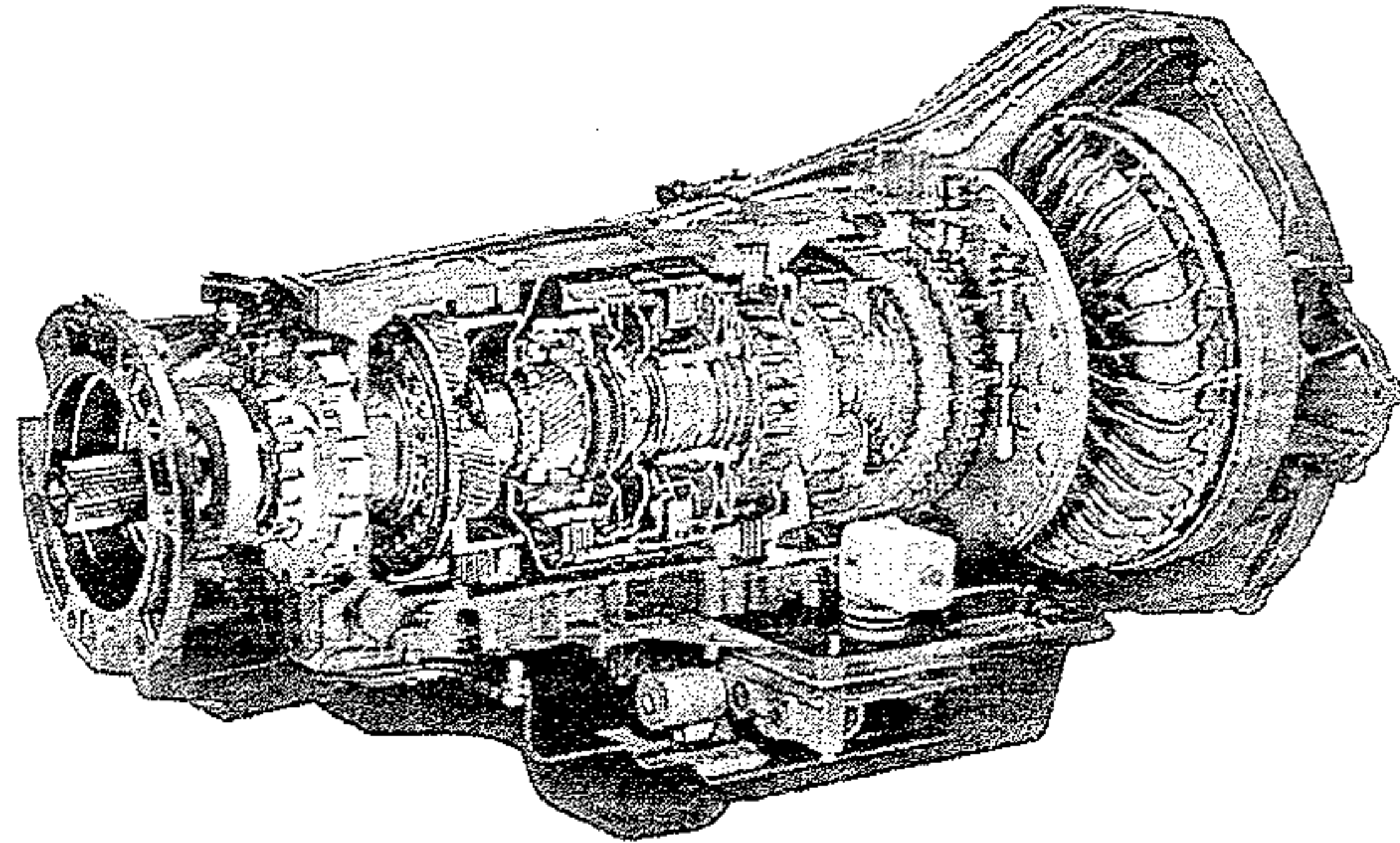

**We proudly welcome all New Customers and Former Advanced Transmission Customers with a 10% Discount and Any Transmission Service or Repair\***

**865-986-9359**

**865-986-5050**

**Bad Credit, No Credit OK!!! We Finance Everybody!!!**

**Low Down Payment!!!**

**Over 100 Cars, Trucks & Vans in Stock - Warranties On ALL Vehicles Sold!!!**

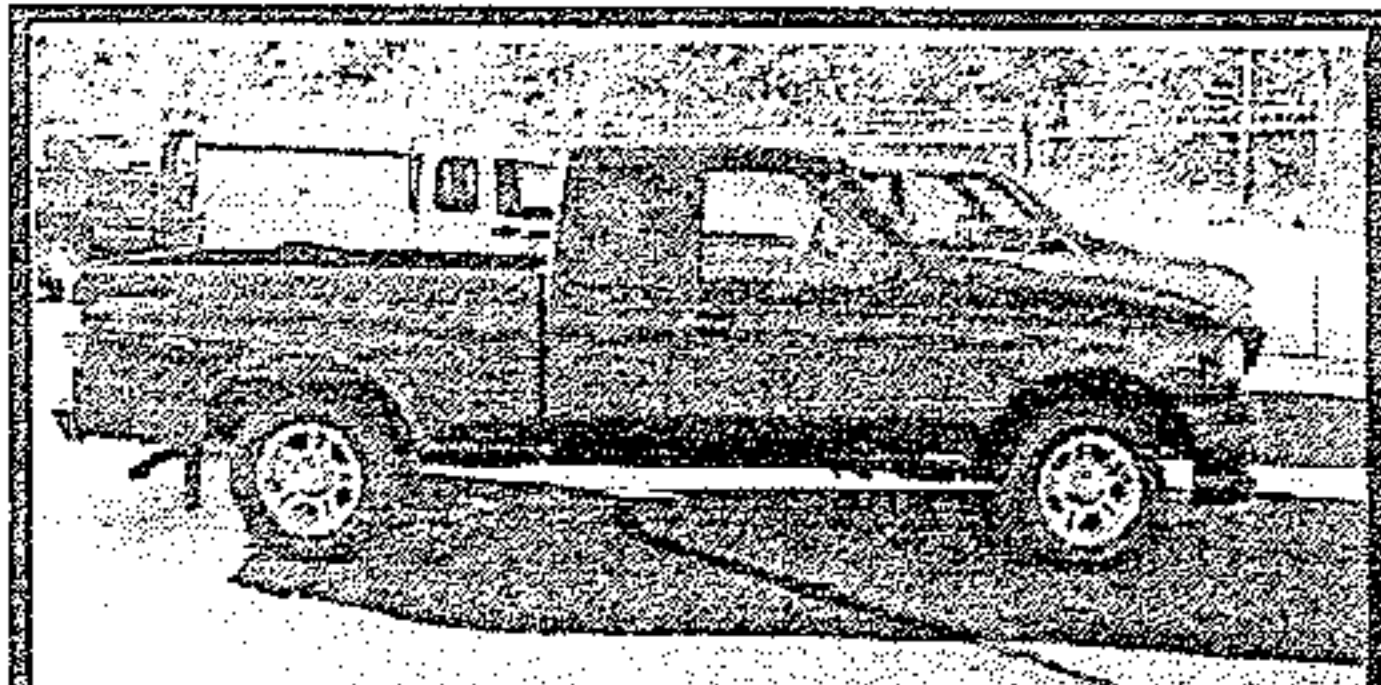

**2005 Ford Ranger, Super Nice Truck, Very Low Miles**

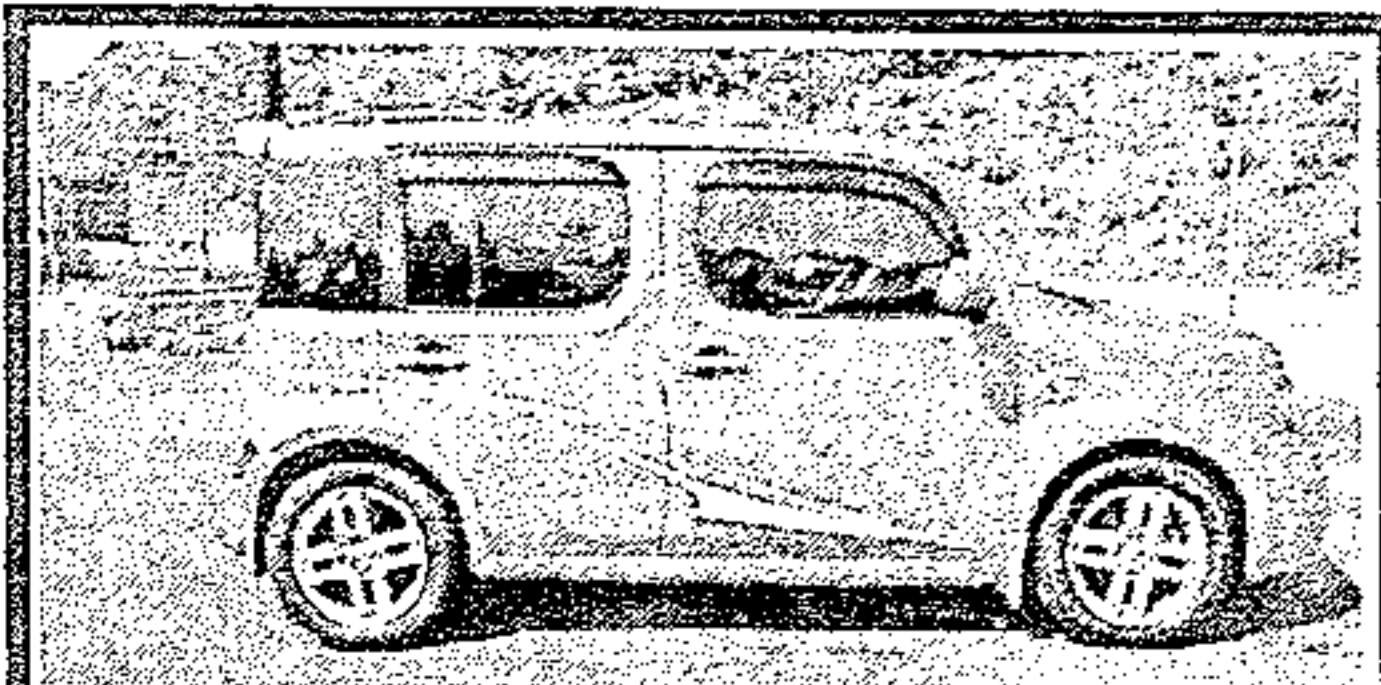

**2009 Nissan Cube, Great Gas Saver, Clean**



**2009 Saturn Vue, Nice Ride, clean ready to roll!!**



**2007 Chevy Equinox, 4dr, Extra Clean, lots of room**



**2008 Chevy Trailblazer, NICE! Loaded**

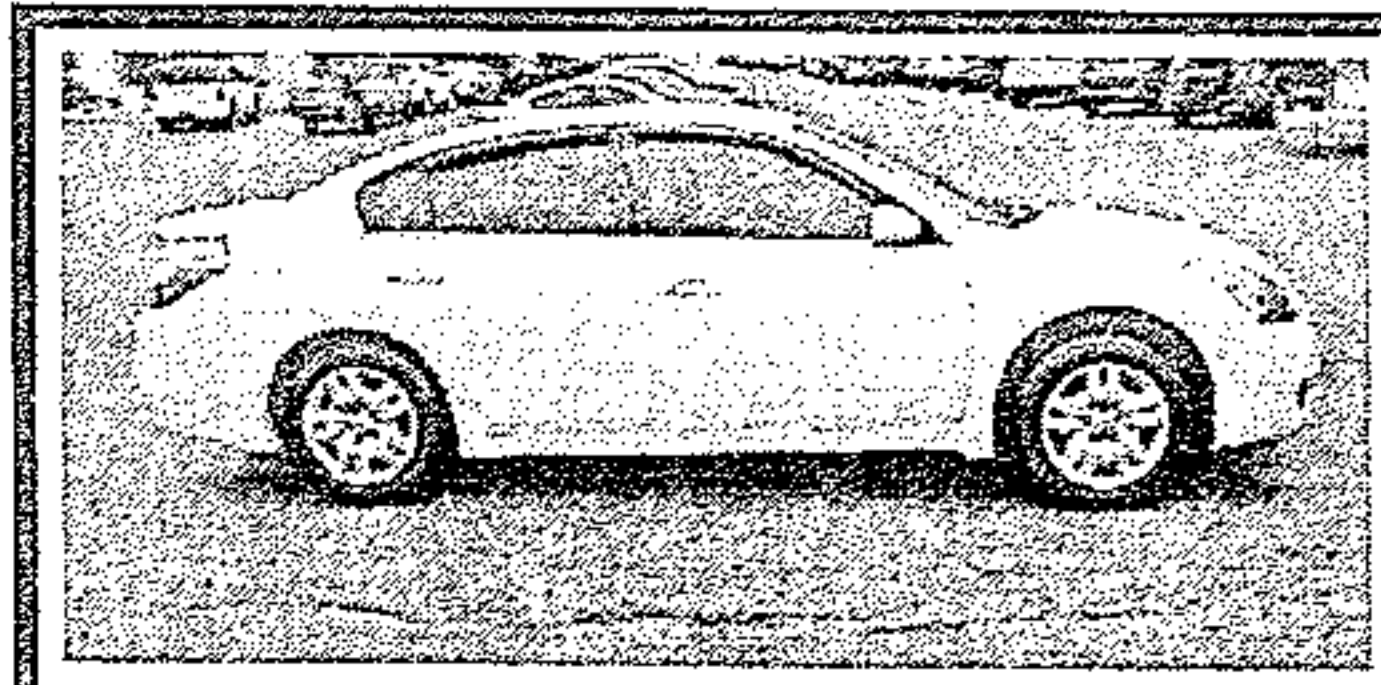

**2009 Nissan Altima, LOADED, Super Nice Sporty Ride**

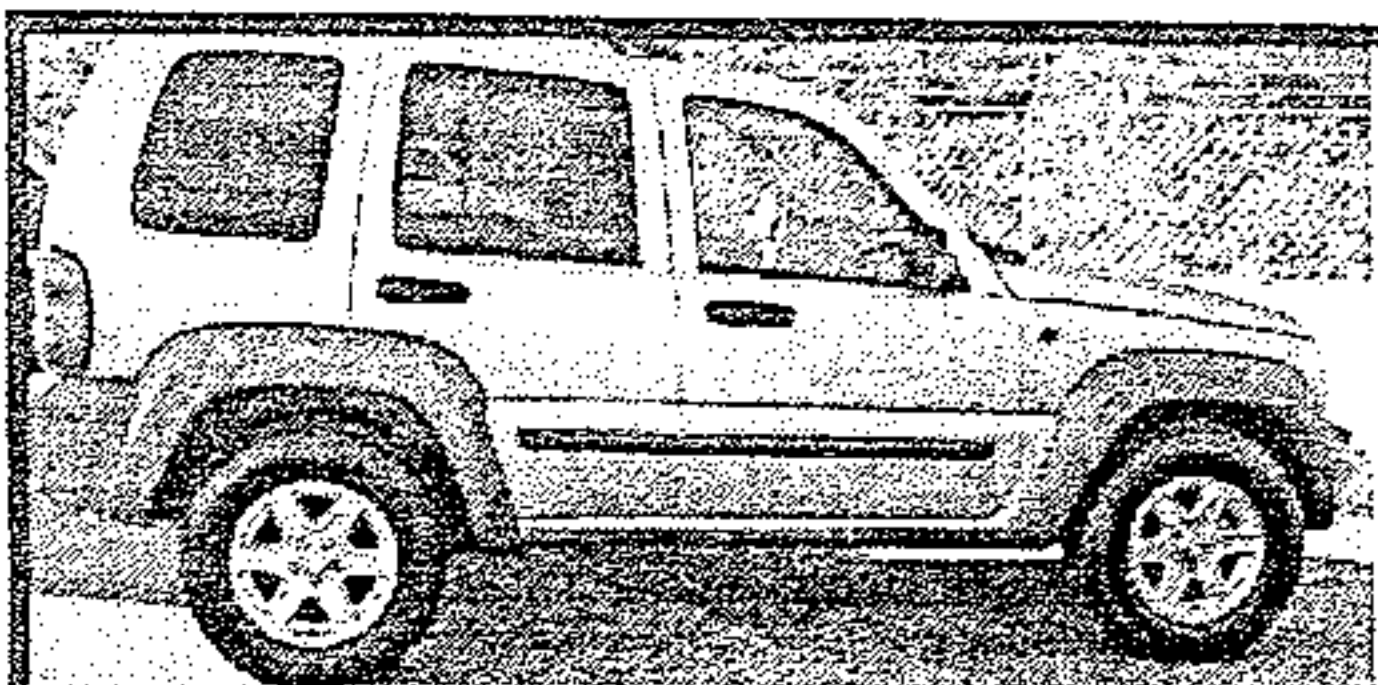

**2004 Jeep Liberty, Nice, Extra Clean**

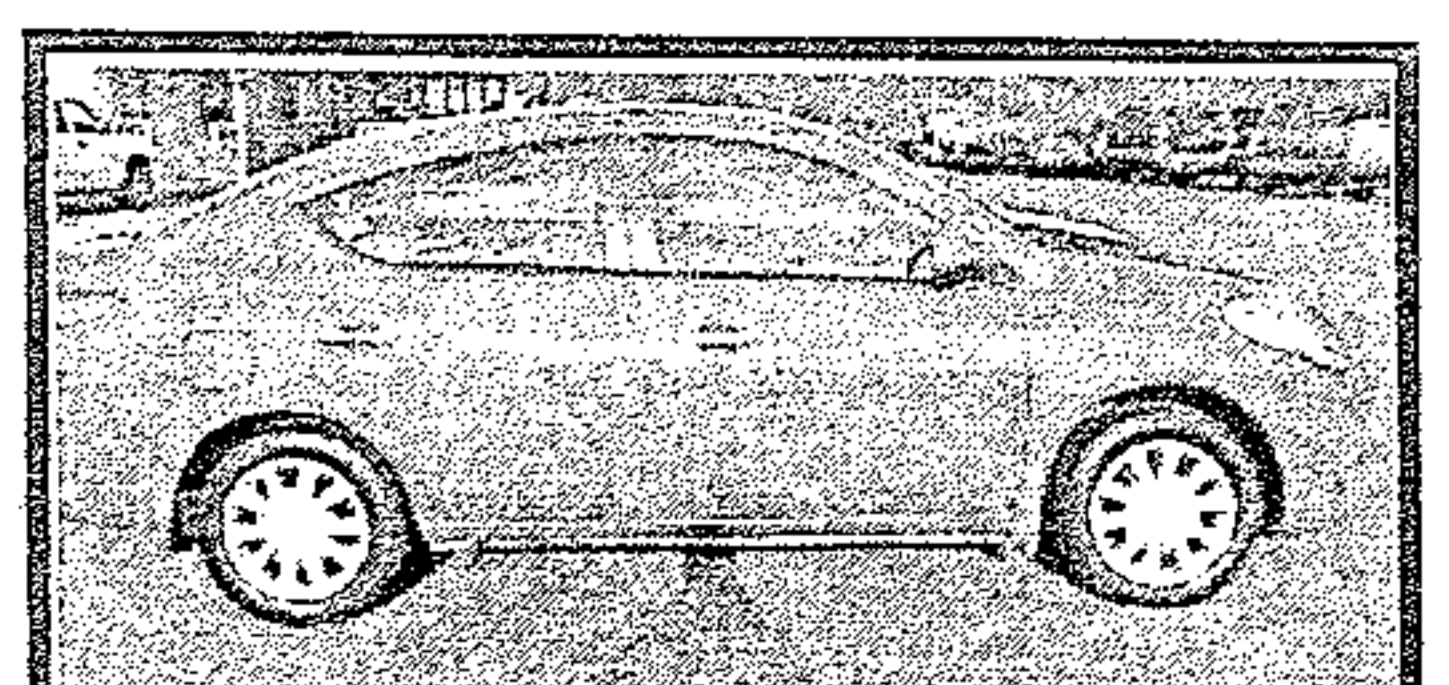

**2013 Nissan Versa, Like New! LOADED!!!**

**WALT WILLIAMS, INC.**

\*with approved credit

3003 Highway 11

Lenoir City, TN

**865-986-1111**