

The Daily Edition

50¢

Serving Loudon, Monroe and Surrounding Counties

Wednesday, November 25, 2015

Did you think they wouldn't search you at jail?

You can't create a scene at that Waffle House!

Echo Bistro Honors Veterans



Jason Babb
(see search pg. 3)



Christina Burkhart
(see theft pg. 2)



(L to R) Renato Cesaretti and Jim McNeece American Legion members; Executive Chef Seth Simmerman of Echo Bistro; Vic Vickery, American Legion Post 256 Commander.
(see legion pg. 5)

Stitches and hospital visit required following attack

Antwan Graham, 32, West 2nd Ave Lenoir City, was charged with Domestic Assault. On 11/4/15, Officer Jeremy Dishner LCPD, was dispatched to Ft. Loudon ER, in reference to a Domestic Assault. Upon arrival Officer made contact with the victim, who advised she had been assaulted by her husband. Victim stated
(see attack pg. 7)



Antwan Graham

Mitchell Lee Chambers sentenced to serve 87 months in prison for conspiracy to distribute synthetic drugs

Defendant Supplied following his term in Tri-Cities Businesses With "Fake Weed" prison.

Mitchell Lee Chambers, 36, of Magnolia, Tex., formerly of Clearwater, Fla., was sentenced on Nov. 23, 2015, by the Honorable J. Ronnie Greer, U.S. District Court Judge, to serve 87 months in federal prison. He was also ordered to forfeit approximately \$500,000 in assets and serve three years of supervised release

Chambers pleaded guilty in August 2015 to charges in a December 2014 indictment including conspiracy to distribute controlled substance analogues intended for human consumption and conspiracy to commit money laundering. He, along with Clearwater area residents Michael Sheaffer and Matthew Sheaffer, and their

(see synthetic pg. 4)

Verse of the Day

For everyone who asks receives; he who seeks finds; and to him who knocks, the door will be opened.
— Luke 11:10

Obituaries

see inside **Wazzup**
Hope everyone has a safe and Happy Thanksgiving this week, and a special Big Shout Out To Our Soldiers serving during

this time of year, Thank You For Your Service!.

Weather

Today: Partly to mostly cloudy. High around 60F.
Tonight: Mostly clear. Low 38F.
Thursday A few clouds

from time to time. High near 65F.
Thursday Night A few clouds from time to time. Low 43F.
Horoscopes
Scorpio 10/23-11/21
You are running on an
(Continued on page 6)



3 08805 93489 2

theft

Christina Burkhart, 41, Mealer Road Lenoir City, was charged with Theft of Property.

Cpl. Pete McGinley LCSO, responded to Mealer Road on a theft of vehicle call.

The victim stated Christina Burkhart who lives next door came to victims house took

the car keys without anyone permission. While on scene

Deputy received a call stating that Christina was at the Waffle House causing a scene. Deputy arrived at the Waffle House and located Christina sitting at a booth with the keys in hand.

Christina was placed under arrest. Cpl. Pete McGinley LCSO, made the arrest.

Call 865-771-2249 to Advertise and start saving today!
Has your group got an event coming up?
Let us know!!!

Notice
 Vin 1G82557N87F202859
 General Motors Vehicle will be sold. If anyone has a lien on this vehicle contact: Homer's Body Shop, 10609 Beals Chapel Road, Lenoir City, 37772, 865-388-0372.

Notice: The Daily Edition does not knowingly accept fraudulent or misleading materials. The Daily Edition cannot guarantee the validity of offerings or statements contained herein. All liability for the contents of all advertising, and for any claims that may arise therefrom, is the responsibility of the advertiser or its agency. The Daily Edition reserves the right to reject, edit, or abbreviate any advertisement submitted. Advertising is accepted with the understanding that all liability for all copyright violations is the sole responsibility of the advertiser.

Photographs, artwork and other copy submitted for publication is considered the sole property of the advertiser. The Daily Edition will make every effort but will not be liable for failure to publish and ad or for typographical and layout errors. All statements and information about highlights featured items, letters to the editor, herein are those solely given to the interviewer or writer and the Daily Edition assumes no responsibility of the accuracy or validity thereof. The Daily Edition will gladly reprint at no charge that part of an advertisement in which an error occurs provided a claim is made within 3 days of the first publication of the ad. Information contained in the Wazzup is received anonymously and the Daily Edition assumes no responsibility for information and reserves the right to edit or reject any and/or all submissions. The Daily Edition is a daily newspaper of general circulation in Loudon County defined under TCA 2-1-104(a)(13).

The Daily Edition also serves Monroe, Knox, Anderson, Roane and Blount counties and serves 30,000 readers weekly. Send mail to PO Box 1240, Lenoir City TN 37771. 865-771-2249. email: dan1204us@yahoo.com

The Daily Edition is Loudon County's premier public interest and paid advertising paper. The Daily Edition is produced and published daily Monday through Friday and is circulated throughout Loudon County and parts of Monroe and Knox Counties. Display advertising rates \$5.00 per column inch and quantity discounts available. Call for information on upcoming promotions and events.



HACIENDA Ayala's
Mexican Restaurant
 Market Dr. * Lenoir City (In Front of Food City)

Real Authentic Mexican Food at Affordable Prices

BEST
MARGARITA



You've Tried The Rest
 Now Come Have The Best!!!

We Accept ALL Competitors Coupons Outside of Mexico City!
 986-3553

Good Credit OK • Bad Credit OK • Bankruptcies OK • Repo OK



2010 Kia Soul Sporty, 4 cyl, Auto, PW, PL, A/C, Great On Gas, Like New



2010 Ford Escape Limited Leather, Alloy Wheels, Heat, A/C, Luggage Rack, 79K,



2007 Dodge Ram 1500 Quad Cab, Thunder Road PKG, 20 in. Wheels, Low Miles, Hemi



2008 Ford Explorer 84k, 3rd Row Seating, Luggage Rack, Tow Pkg, PW, PL



2011 Ford Ranger Low Miles, Tow Pkg, New Tires, A/C, Heat, Bed Liner.



2011 Dodge Grand Caravan DVD, Stow & Go, Loaded, Remote Doors, Rear A/C

DEPENDABLE MOTORS 986-9343

803 E. Broadway • Lenoir City

Serving Loudon County for 20 Years

* WAC. See Dealer for details

Visit our website at: www.dependablemotorslc.com

search

Jason Babb, 41, White Wing Road Lenoir City, was charged with Attachment and Contraband in a Penal Facility. Deputy JC Schultz LCSO, served an attachment on Jason at the White Wing address and transported him to the Loudon Jail, While at the jail Jason was asked if he had anything on him before he was searched he stated no twice. .7 grams of marijuana was located on in Jason right front pocket. Jason was charged . Deputy JC Schultz LCSO, made the arrest.

and Aurora University. Joe was a member of The Community Church at Tellico Village where he was the founder of the Tellico Joe Caf  . Joe was also a member of St. John Lutheran Church in Joliet, IL. He was the founder and charter president of the Tellico Village Lions Club and a 42 year Lion earning a Melvin Jones. Joe was always very active in community service

everywhere he lived including work with the American Cancer Society, Sheltered Workshop, and church work. Survivors include his wife of 50 years, Kay Zusag Klint; son Joseph Michael Klint (Melanie) and daughter Susan Redfield (Charles); grandchildren Avery and Matthew Redfield and Alexandra and Hamilton Klint; sisters Kay Jevitz and Susan Costigan (Michael); niece Katy Hagman (Bill) and

nephew John Jevitz. A Celebration of Life Service will be held on Saturday, November 28, 2015 at 11 a.m. in the Founders Chapel at The Community Church at Tellico Village. The family will receive friends immediately following the service. In lieu of flowers, memorials may be made to The Community Church at Tellico Village, St. John Lutheran Church in Joliet, IL. or to the Lions Club.

Obituaries

Joseph E. Klint III (Bud), age 76 of the Tellico Village Community passed away November 23, 2015. Born November 19, 1939 in Joliet, IL to Joseph E. Klint II and Berta Isberg Klint. He graduated from Joliet Township High School

For Sale: Oak Wood Mulch

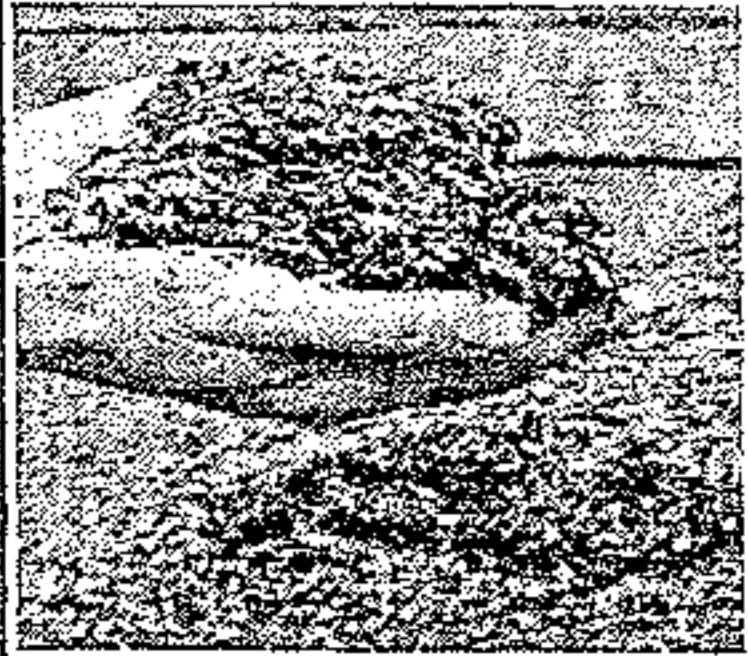

Mushroom Compost Topsoil.



Firewood

Call Steve Spoon
986-4282

West End Storage & Warehouses
502 Ward Avenue • Loudon
Call 865-458-4774 or 865-679-5555

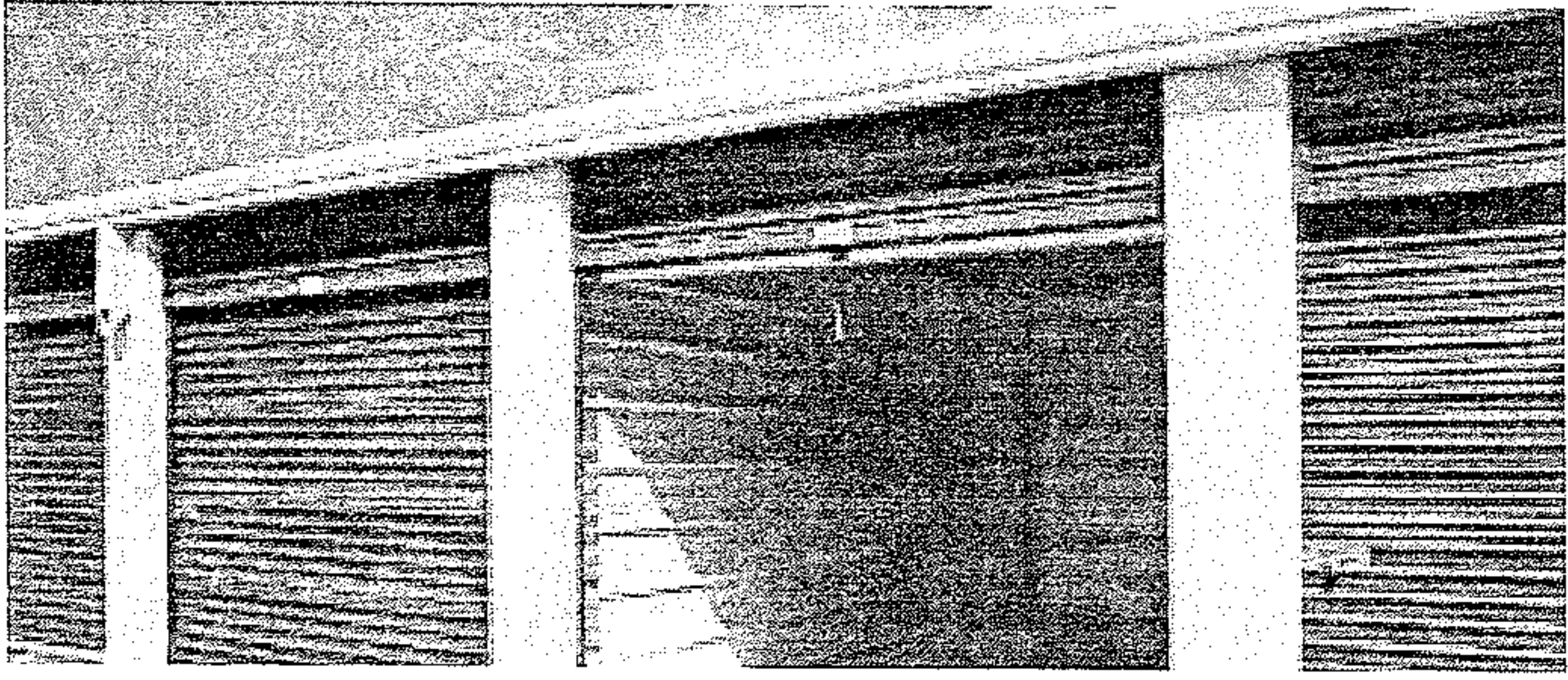

C&C Lawn Care
 Mowing, Mulching, Trimming, Edging, Clear Debris
 Free Estimates
 Call Chad 865-271-8070



BIMBO'S
 Deli Open 24 Hours
 865-986-9643 Call Ins Welcome
 Specials
 Lg. Cold Sub, bag of chips and 16 oz. fountain drink
 only \$6.29
 Footlong Corn Dog \$2.59

C&J Towing and Recovery
LOWEST TOWING RATES AROUND!!!

Have you been overcharged for any type of towing service in the Lenoir City area? If you have a breakdown or accident please OWNER REQUEST C&J Towing with the officer. Also please call your Sheriff and ask him to place C&J Towing on the "Rotation List*" and help other motorists save as much as you did! We at C&J are locally owned and operated, State approved, licensed, bonded and insured. Call and let us know if your denied service or how we can be of assistance.

*note: the "Rotation List" is a list of wrecker services that provide service for wrecks, DUI's, breakdowns, etc. and are on an on-call basis for service. This list is approved by the Sheriff.

Cliff Teeters • Owner
865-809-1661

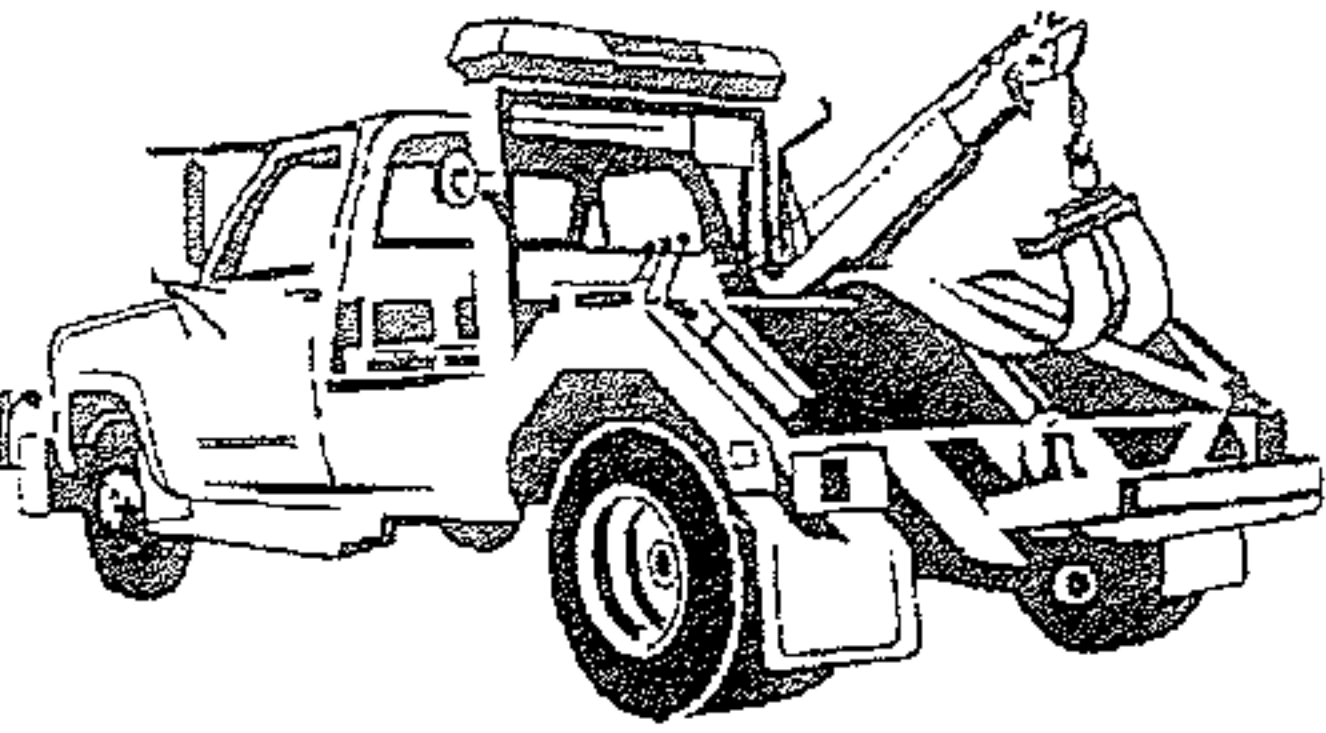

Synthetic

wives Gretchen Sheaffer and Niki Maxwell, conspired to distribute controlled substance analogues intended for human consumption as well as conduct financial transactions in the proceeds of the drug trafficking to promote the distribution of the synthetic drugs.

Chambers became involved in the sale of smokable synthetic cannabinoid products while residing in Atlanta in 2010. He formed a business called "Satchel Services" to market "incense" and "fake weed" products. The products consisted of a smokable plant material, often the plant damiana, on which synthetic cannabinoids had been sprayed. Chambers sold the products to

the Sheaffers, who in turn re-sold the products to retail distributors in upper east Tennessee and elsewhere. The products contained cannabimimetic agents commonly referred to as bath salts. These chemicals were classified as Schedule I controlled substances in March 2011. Chambers ordered the raw

chemicals in bulk from sources in China, Europe, and elsewhere.

In approximately August 2011, Chambers moved from Atlanta to the Clearwater area to join the Sheaffers in their activities. Michael Sheaffer, Matthew Sheaffer and Chambers agreed to form a business called "Zombie Interna-

tional." Zombie International continued to use the Internet, phone calls and text messages to receive orders for controlled substance analogues intended for human consumption. In addition to products which were labeled "Zombie" and "Zombie Killa," Zombie International also sold a

product in early 2012 labeled "Zombie Dust" which contained the controlled substance analogue α -PVP (also known as "gravel" or "flakka"). Chambers and the Sheaffers agreed to use funds obtained from the sale of controlled substance analogues intended (see synthetic ctd. pg. 7)

SARCO Enterprises Inc. Offers Complete Home and Commercial Remolding and Repairs

Our Team members have a combined total of over 40 years experience in all areas of home construction, facilities maintenance and commercial construction. Roofing, Electrical, Bath and Kitchen Renovations, we do it all with just one call. We are fully insured and our work is guaranteed.

Call us today for a free no obligation quote for your next project.
865-809-9492.

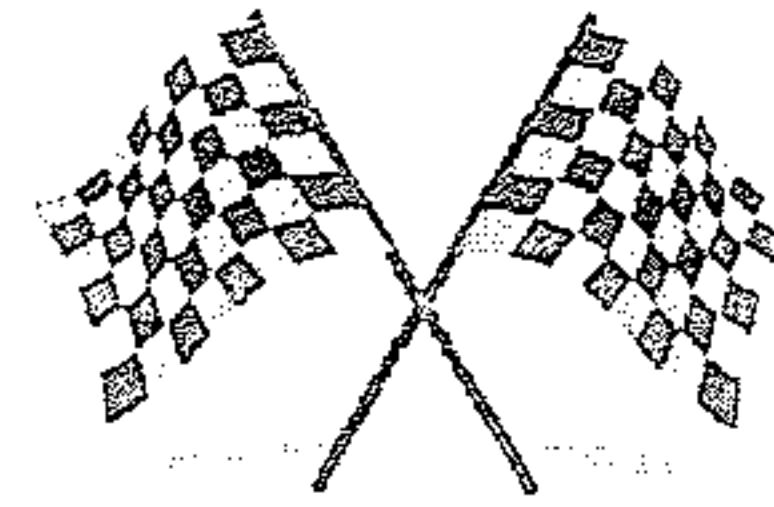

SOUTHERN AUTO DETAILING

**414 WEST BROADWAY
LENOIR CITY, TN 37771
865-986-0724**

**Starting at \$34.95
Present this ad for \$5.00 off**

**BUDGET
Transmissions**

Why Buy From Budget?

- Free Towing From Lenoir City or Loudon County
- 20 Years of BBB Zero Customer Complaints Award Member
- A+ Plus Rated
- Huge Transmission Inventory
- Best Technicians Period!!!

Call (865) 584-4391 Today!

**302 S. Northshore Drive Knoxville
(865) 584-4391**

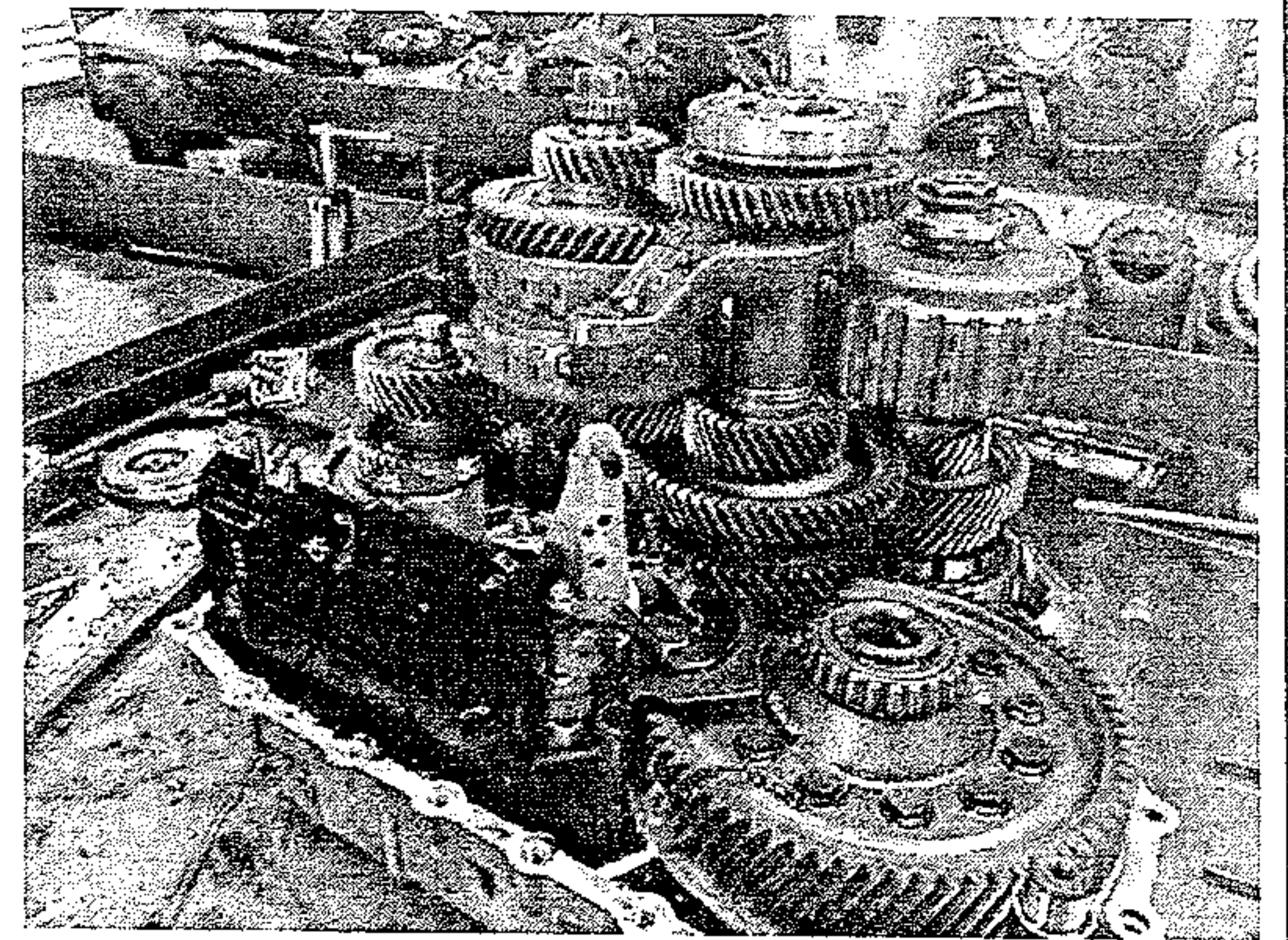

State-of-the-Art Diagnostics

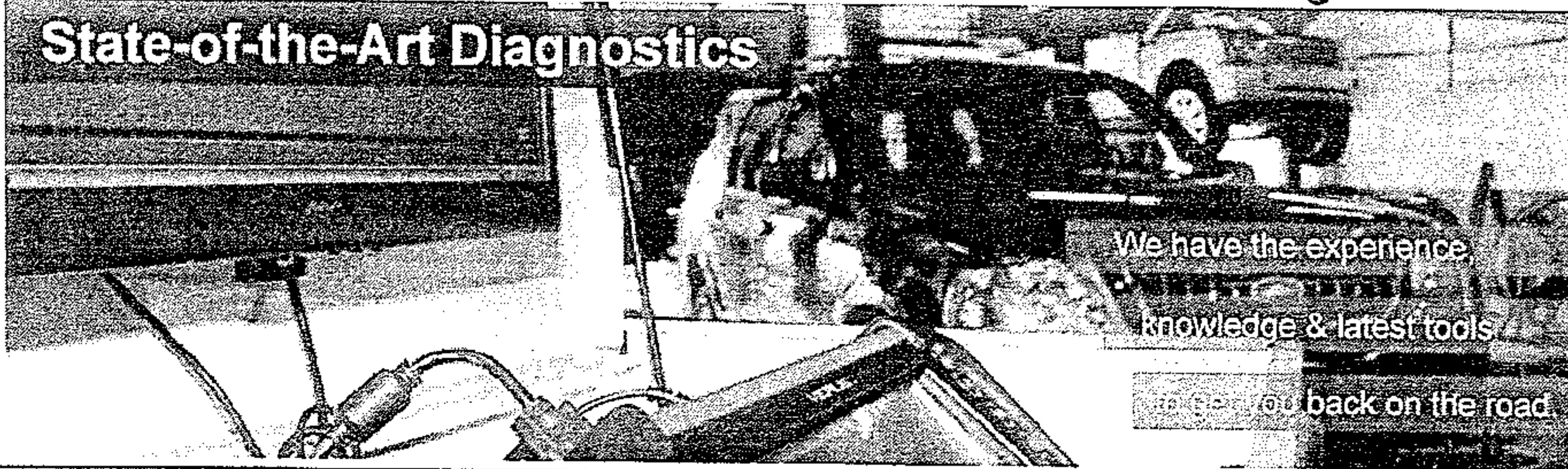

We have the experience, knowledge & latest tools to get you back on the road.

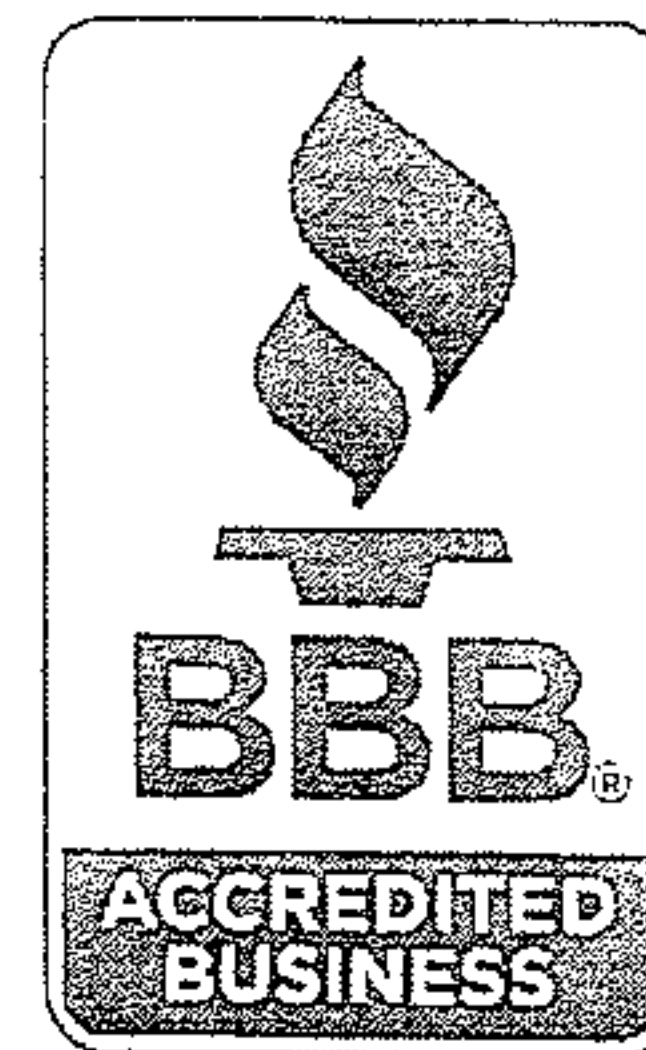

budget-transmissions.com



Approved Auto Repair



legion

Members of American Legion Post 256, Tellico Lake, join Executive Chef Seth Simmerman at the Echo Bistro for Seth's annual tribute to veterans. Chef Seth hosts free dinners to veterans to celebrate Veterans Day, as a tribute and thanks to veterans. Executive Chef Simmerman, for several years, has provided countless free

dinners to veterans of all wars to honor their military service. Post 256 salutes fellow Veteran Executive Chef Seth Simmerman as a true patriot and exemplary citizen. For additional information about the American Legion contact Commander Vic Vickery, 423-884-6476 or visit the website: www.TellicoLakePost256.org.

Obituaries

Robin Elaine King Simmons - age 53 of Loudon passed away Sunday, November 22, 2015. She was a member of Jackson Chapel Baptist Church. Preceded in death by her husband, Mike Simmons of Georgia; parents, Junior and Sammie Jean King. She is survived by her children, Robby Forrester and Thomas Cross; 7 step children; sisters, Connie Coffman and husband, Larry, and

Becky Sutton ; brother, Jeff King and wife, Mary; several nieces, nephews and cousins. Memorial services will be held at 10 a.m. Wednesday, November 25th at Jackson Chapel Baptist Church on Markwood Road in Loudon. Click Funeral Home, Lenoir City is in charge of arrangements. James William Watkins "Jim Bill" age 72 of Loudon, passed away Monday, November 23, 2015. Jim was a lifelong member of Loudon United

Methodist Church where he served as a Chancel choir member, a Sunday school teacher, a Library committee and Historical committee member, a prayer chain member, and assisted with the church's 50th anniversary celebration. Jim was a graduate of Loudon High School, class of 1961 and also attended the University of Tennessee, Knoxville. He was formerly employed as a clerk in the Watkins store and as a dispatcher at the Loudon Co. Justice Center. Jim was very interested in history and genealogy, most notably serving on the committee for a book on Loudon County Tennessee's history spanning 1870 - 1979 writing quite a bit of historical material for the book. Preceded in death by his parents, Joseph V. and Katheryne (Bost) Watkins and brother, Ernest Watkins. Survivors include his sister, Joe Anne (Watkins) Moore; sister-in-law, Will Ann Watkins; aunt, Joyce (Bost) Hogan; 8 nieces and nephews, numerous cousins; many great and great-great nieces and nephews and faithful friend and classmate, Joe Mourfield. Many thanks should be expressed to the Senior Citizen Home Assistance Service (SCHAS) for their kind and caring assistance. Contributions in memory of Jim may be made to the Watkins Cemetery Fund, or to the Loudon United Methodist Church, P.O. Box 342, Loudon, TN 37774. Services honoring and remembering Jim Watkins will be held 3:00 PM Wednesday, Nov. 25th, McGill-Karnes Chapel with Rev. Aubrey Watkins officiating. Interment to follow in Watkins Cemetery. The family will receive friends 1:30 - 3:00 PM prior to the service at McGill-Karnes Funeral Home, 406 Wharf St. Loudon, TN www.mcgillkarnes.com

PURDY'S AUTO PARTS AND SALVAGE
WE BUY SCRAP IRON • COPPER • BRASS • ALUMINUM

\$ **Paying Top \$\$\$**
Call For Latest Prices

You Name It, We Buy It!

Radiators, Wheels, Batteries, Appliances, Farm Equipment

Copper
Paying Top \$\$\$
Call For Latest Prices

Complete Cars
per 100 lbs.

Scrap Metal
Paying Top \$\$\$
Call For Latest Prices
per 100 lb

We Buy Batteries

Aluminum Cans
Paying Top \$\$\$
Call For Latest Prices

You Call We Haul!
423-519-5402

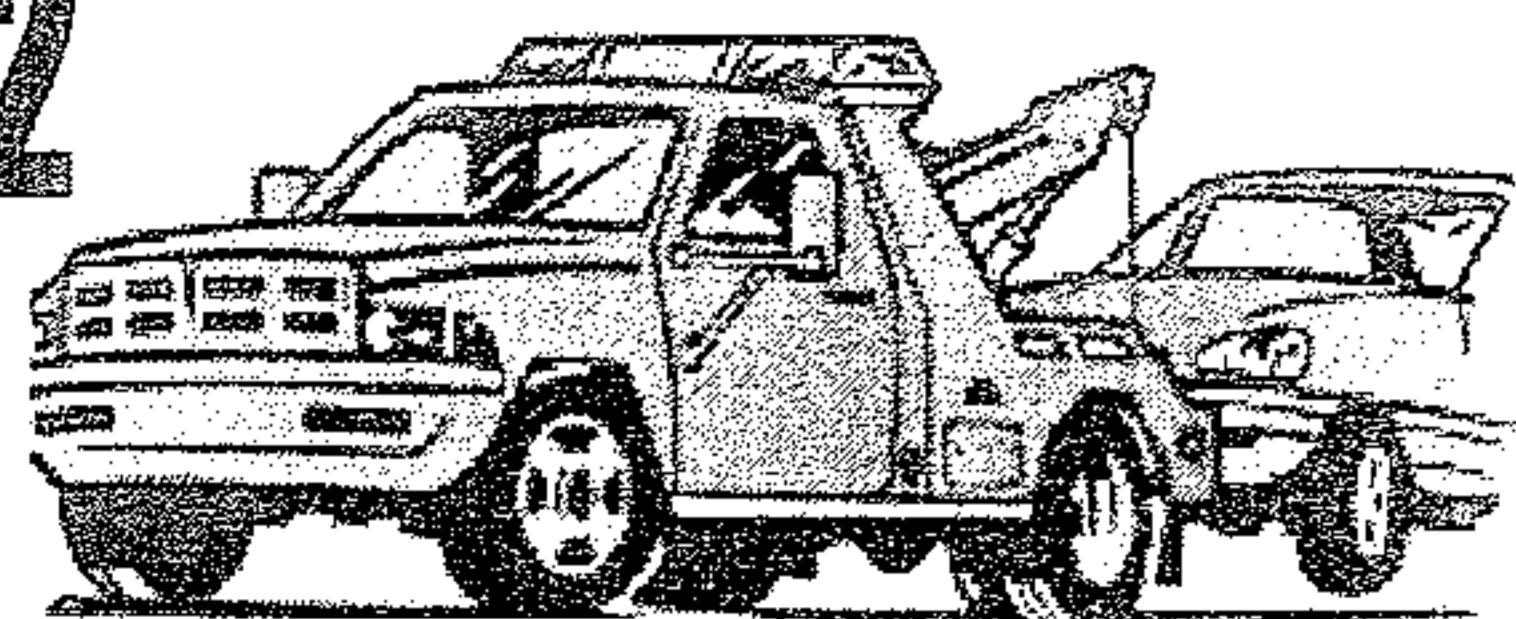

Now Selling
Aftermarket
Body Parts at
Discount Prices

* Prices subject to change with the market.

423 337-3977
149 County Road 323 Sweetwater

* Prices subject to change with the market.

attack

they argued over the couples financial struggles when Antwan tackled victim. During the assault victim sustained a large cut to her hand and between her middle and ring finger that required several stitches. Antwan fled the scene. Deputy Jamie Ketner LCSO, arrested Antwan at the West 2nd Ave and transported him to Loudon Jail.

synthetic ctd. from pg. 4

for human consumption to purchase additional analogues from sources in China and Europe.

While many believed

that synthetic marijuana products were less harmful than other drugs, such products have been shown to result in extreme paranoia and psychoses; agitated and violent behavior; and elevated heart rates, blood pressure, and body temperatures. Other adverse effects include excited delirium, acute kidney injury, seizures, psychosis, hallucinations, cardiotoxic effects, coma, and death. Medical treatment for the users of such drugs is complicated because there are no available antidotes, such as for opioid overdoses, and physicians often do not know what substance is involved. Synthetic marijuana

products are often targeted at teenagers and young adults with colorful packaging with cartoon characters. A study by the Center for Substance Abuse Research identified synthetic marijuana as the third most reported substance used by U.S. high school students after alcohol and marijuana.

Agencies involved in this investigation included the Drug Enforcement Administration, Internal Revenue Service-Criminal Investigation, Sullivan County Sheriff's Office, Bristol Tennessee and Virginia Police Departments, Kingsport Police Department, Washington County Sheriff's Office, John-

son City Police Department, the First and Second Judicial District Drug Task Forces, and the Clearwater, Florida Police Department. Assistant U.S. Attorney Neil Smith represented the United States.

Loudon County Sheriff's Office Toys for Tots 2015

Thanks to the generosity year after year of the Loudon County residents, churches, businesses and industries, the Loudon

County Sheriff's Office is once again able to offer the Toys for Tots program. We are beginning our 31st year of providing toys to the needy children of Loudon County, and thanks to generous contributions of time, money and gifts, we are able to make Christmas a more joyful time for more and more children. In 2014, approximately 500 children were helped by the Loudon County

(see T4T ctd. pg. 8)

Is Your Washer Broken?

Call Me

I Only Charge \$100 Period!!!

Call Allen

865-617-7113

LOOK!

\$75 Weekly Payments

LOOK!

MARTY'S AUTO SALES • 986-2222 • MARTY'S AUTO SALES • 986-2222 • MARTY'S AUTO SALES • 986-2222 • MARTY'S AUTO SALES • 986-2222 • MARTY'S AUTO SALES • 986-2222

- Bad Credit
- Divorce
- Fixed Income
- Repos
- Bankruptcy
- No Credit

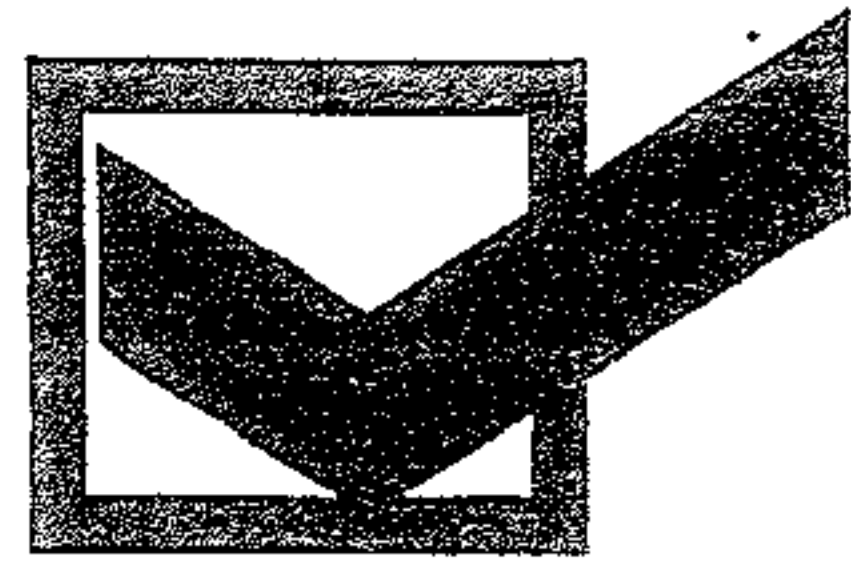

APPROVED!

Visit Us On The Web At:
martysautosales.net

NO CREDIT CHECKS

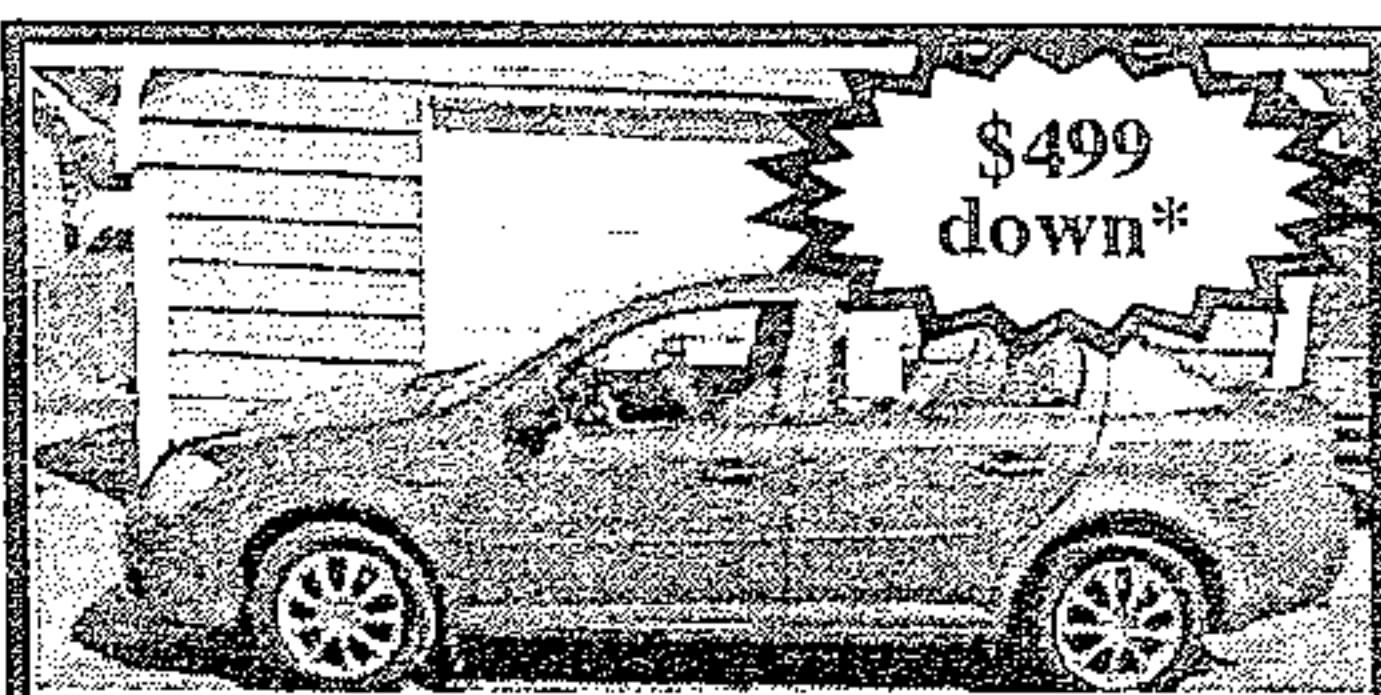

\$499 down*

07 Cobalt, 5spd, gas saver, runs great Only \$499 down *

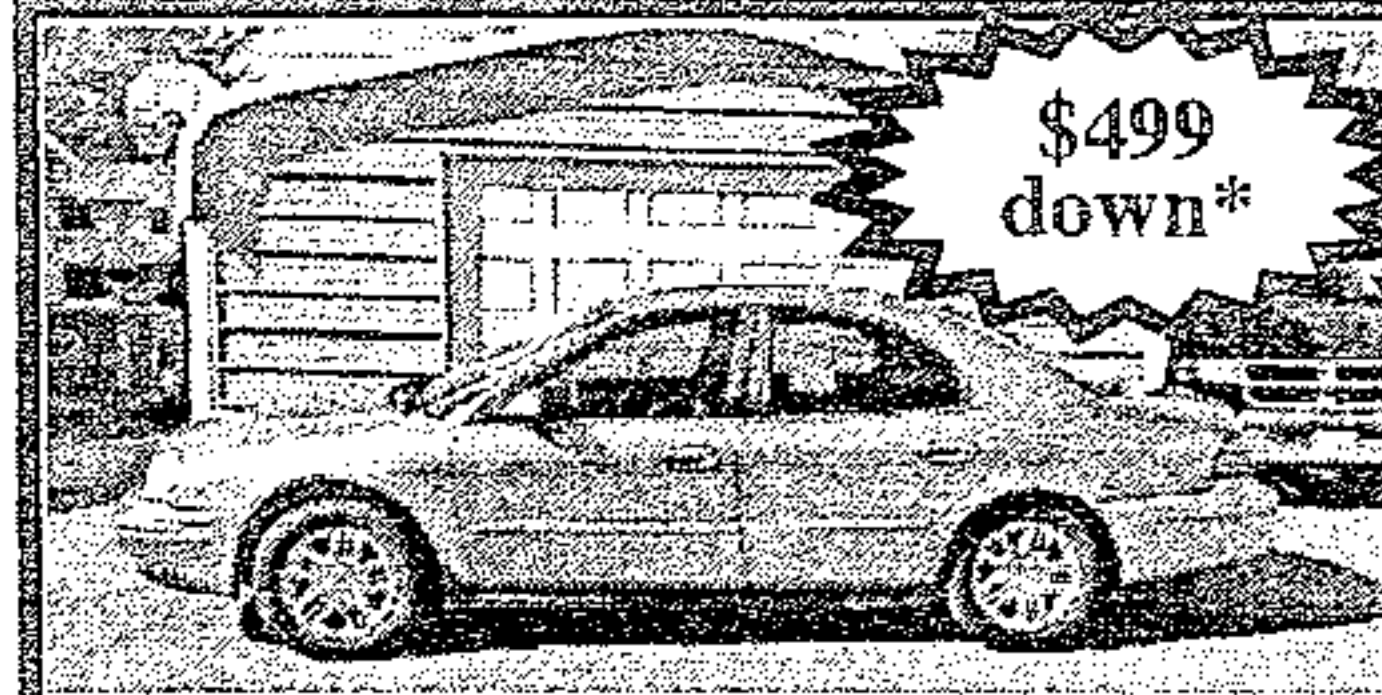

\$499 down*

02 Sable, sunroof, loaded, Only \$499 down *

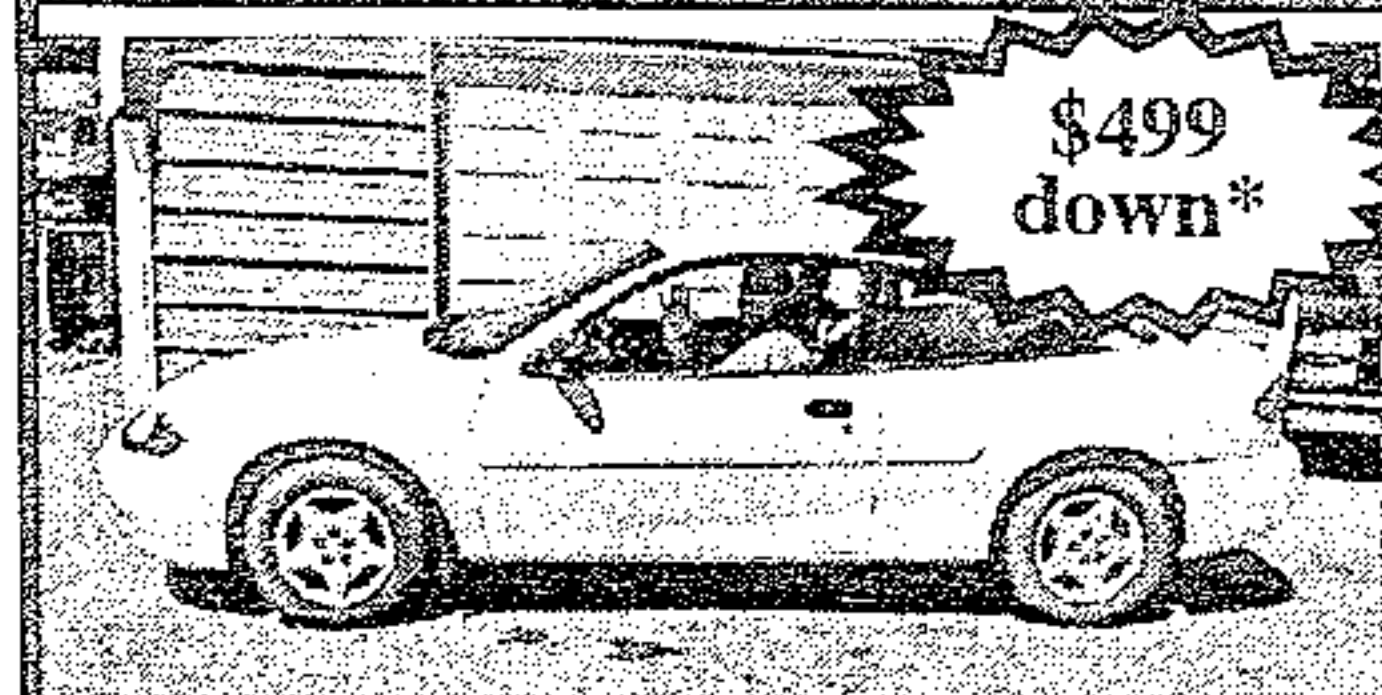

\$499 down*

04 Cavalier, 2dr, Sporty, Only \$499 down *

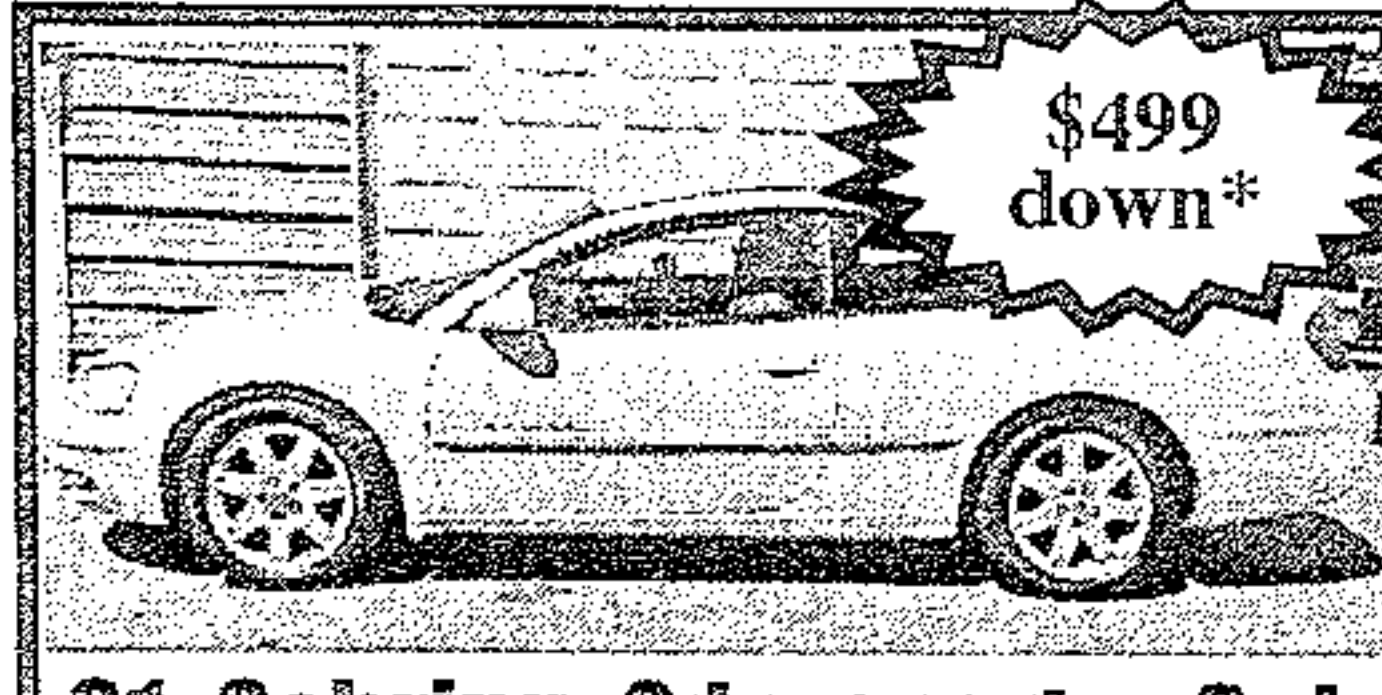

\$499 down*

01 Sebring 2dr. sporty, Only \$499 down *

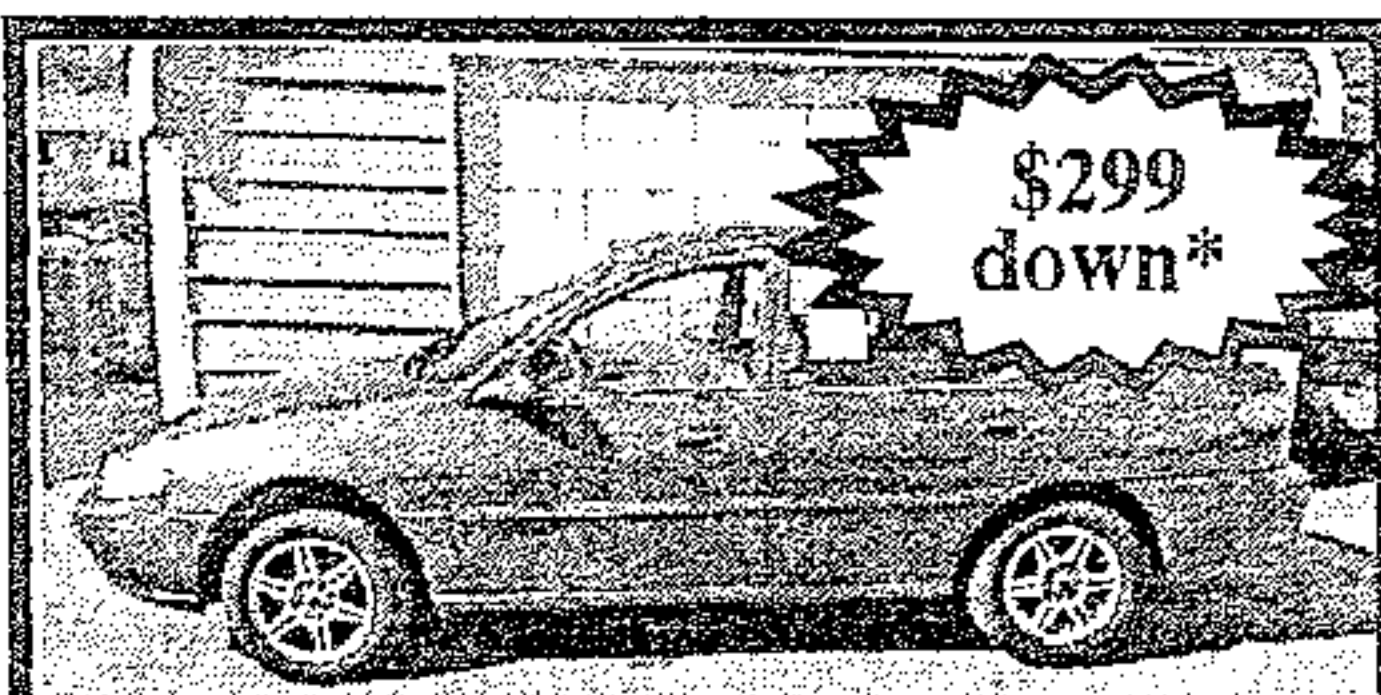

\$299 down*

97 Escort, auto, Gas Saver, Only \$299 down *

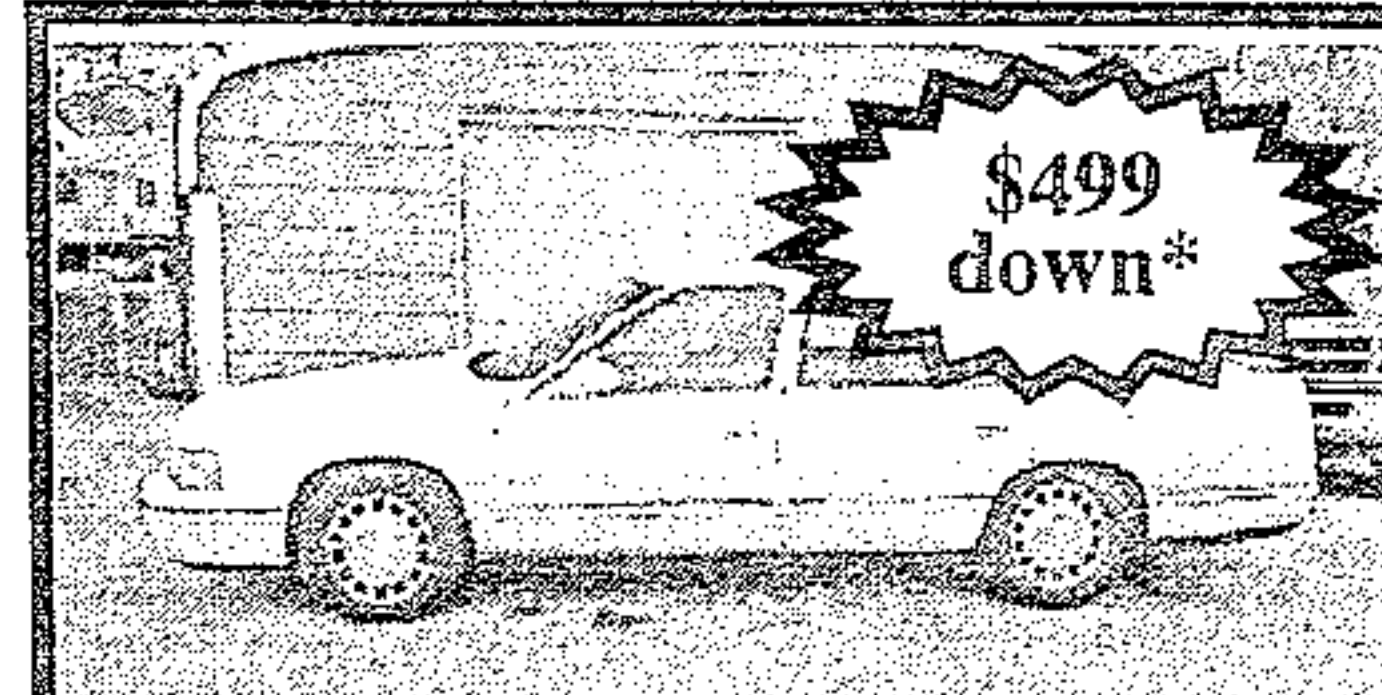

\$499 down*

99 Deville, Loaded, Luxury, Nice Only \$499 down *

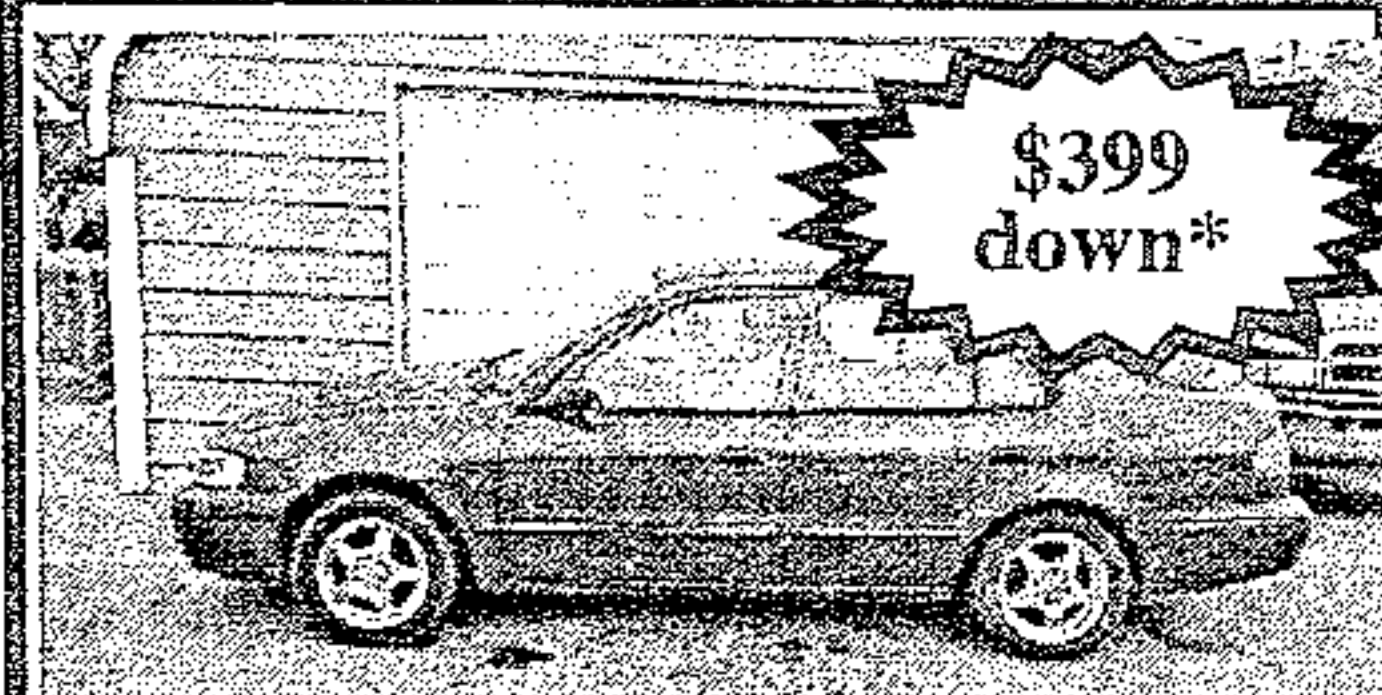

\$399 down*

99 Corolla, auto, Gas Saver, Only \$399 down *

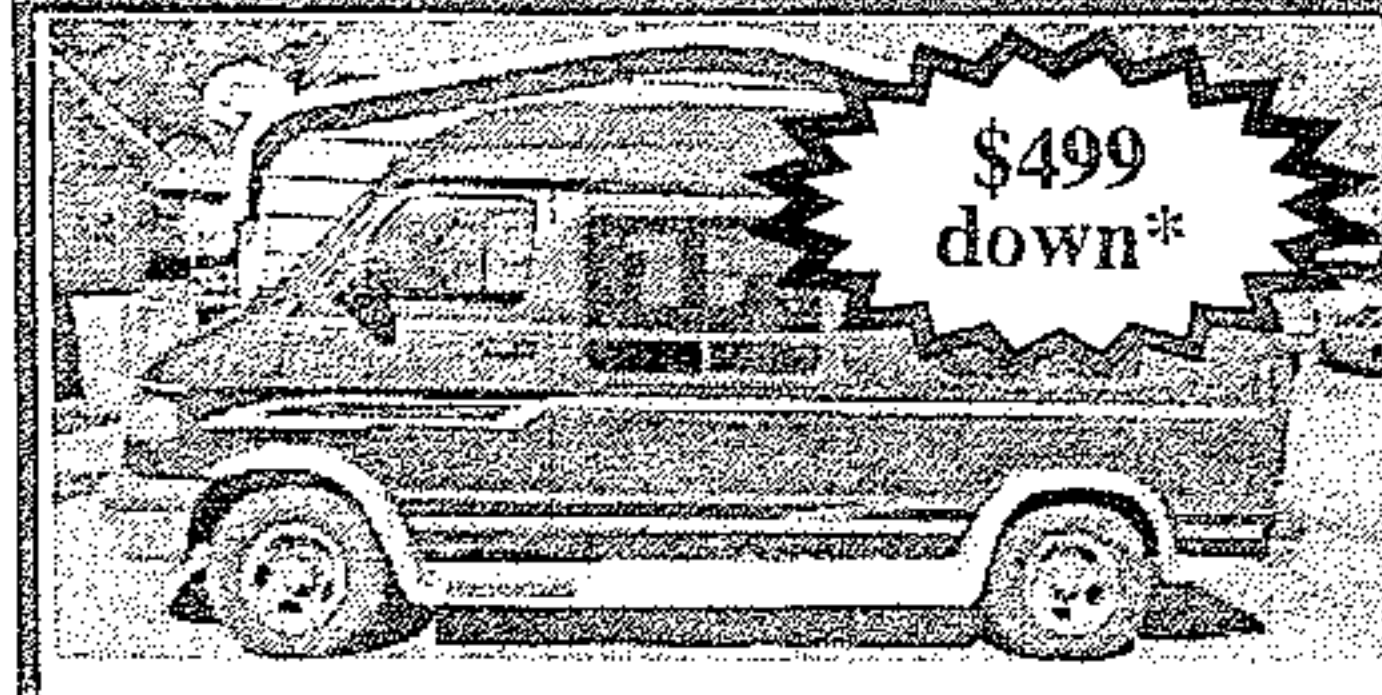

\$499 down*

00 Ram, High Top Conversion Van, Loaded only \$499 down *

NO Credit Checks

Marty's Auto Sales
986-2222

Se Habla Espanol

100% Approval*

*See Dealer for details. All down payments plus tax, tag, title and fees.

MARTY'S AUTO SALES • 986-2222 • MARTY'S AUTO SALES • 986-2222 • MARTY'S AUTO SALES • 986-2222 • MARTY'S AUTO SALES • 986-2222 • MARTY'S AUTO SALES • 986-2222

Sheriff's Department Toys for Tots program through their partners. Even with the difficult economic times we are experiencing, we hope that the people of Loudon County will be there once again to help.

If your business or church would be willing to take names please call Debbie Hines, Toys for Tots Coordinator at 986-

4823.

Names are available through business and churches. If you are considering helping a child this Christmas, please be assured that applicants are thoroughly checked to make sure they require this assistance. Names are also compared with the school systems to make sure no one is receiving duplicate assistance.

LONNIE JONES OPTICAL DISPENSARY

"We Make The Difference You Can See"
Locally Owned and Operated

Over 1000 Frames To Choose From
No Frame Over \$69.00



On the corner of A & Depot Street, Lenoir City

986-7803

Serving Loudon County for over 40 years

A Name You Already Know And Trust Just Got Even More Dependable
DEPENDABLE AUTO SERVICE, LUBE AND TIRES
is Now Offering
Expert, Affordable Transmission Service

All ASE Certified Technicians

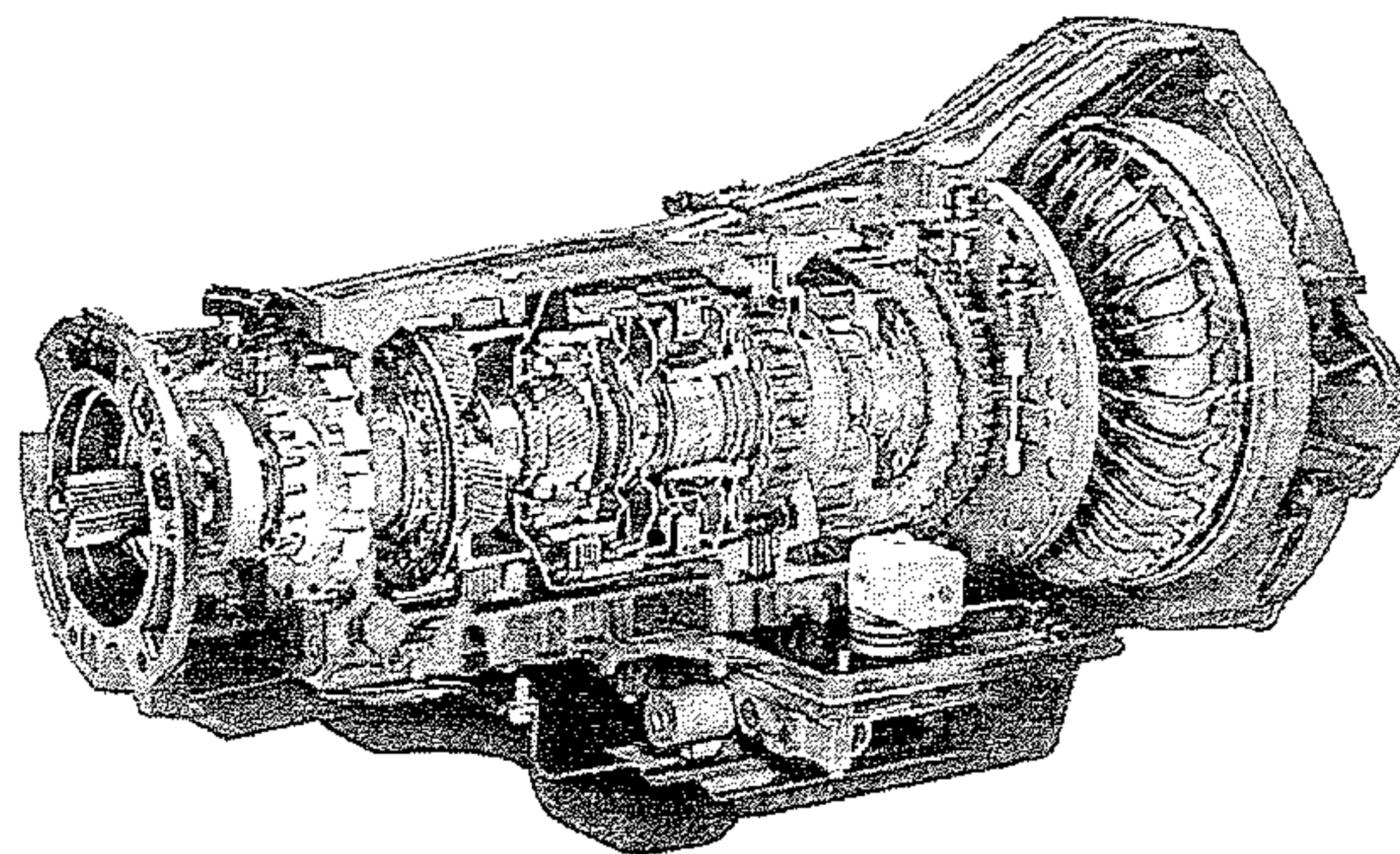

We proudly welcome all New Customers and Former Advanced Transmission Customers with a 10% Discount and Any Transmission Service or Repair*

865-986-9359

865-986-5050

Bad Credit, No Credit OK!!! We Finance Everybody!!!

Low Down Payment!!!

Over 100 Cars, Trucks & Vans in Stock - Warranties On ALL Vehicles Sold!!!

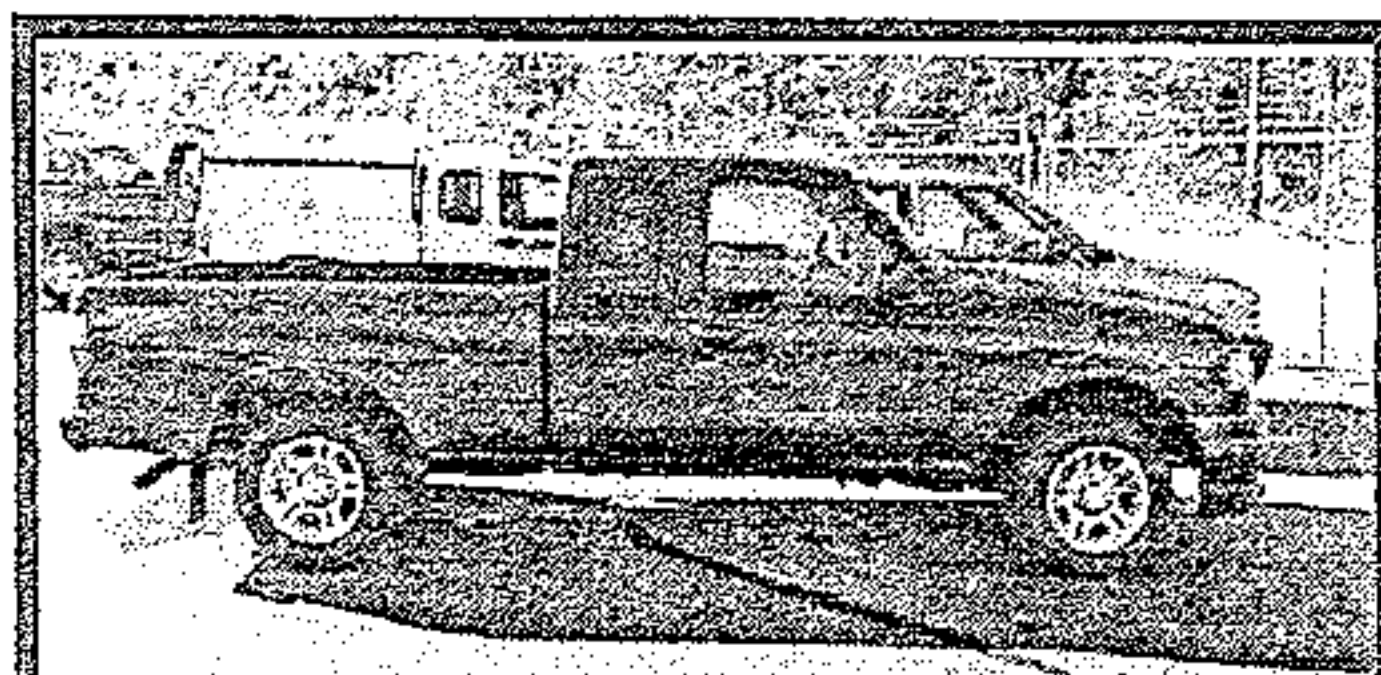

2005 Ford Ranger, Super Nice Truck, Very Low Miles

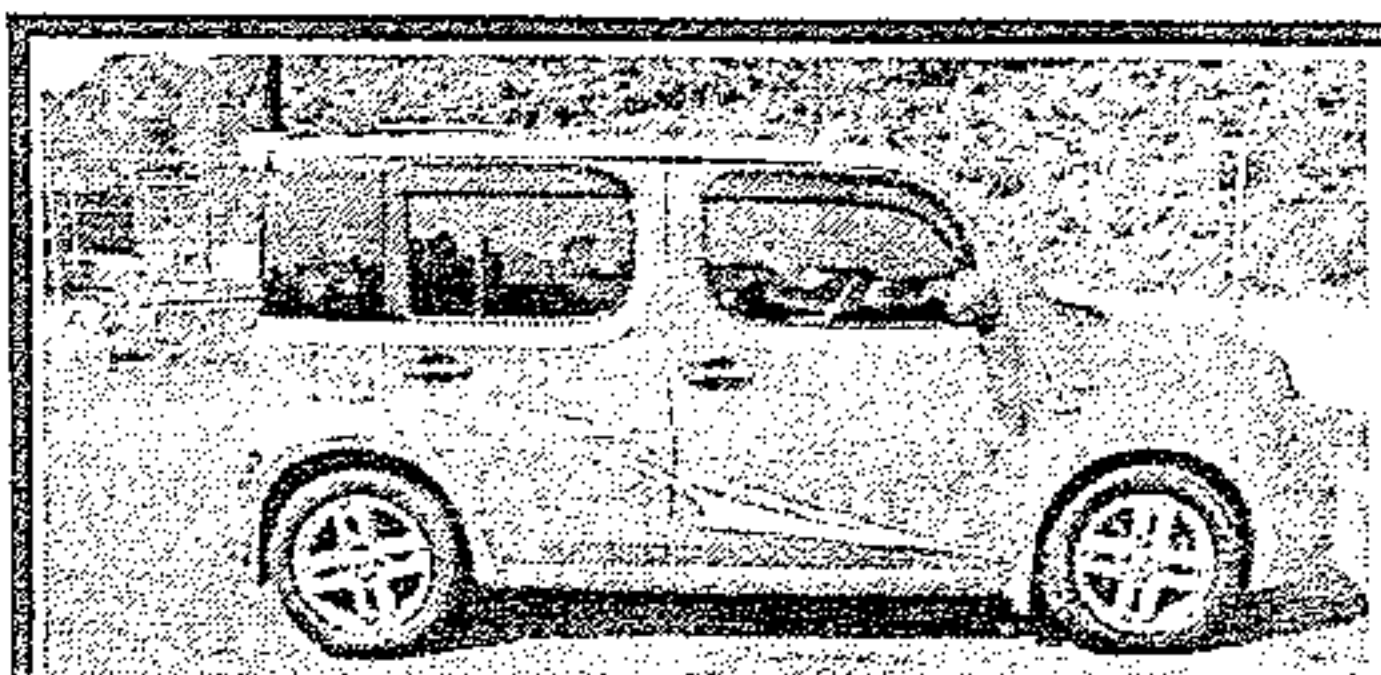

2009 Nissan Cube, Great Gas Saver, Clean



2009 Saturn Vue, Nice Ride, clean ready to roll!



2007 Chevy Equinox, 4dr, Extra Clean, lots of room

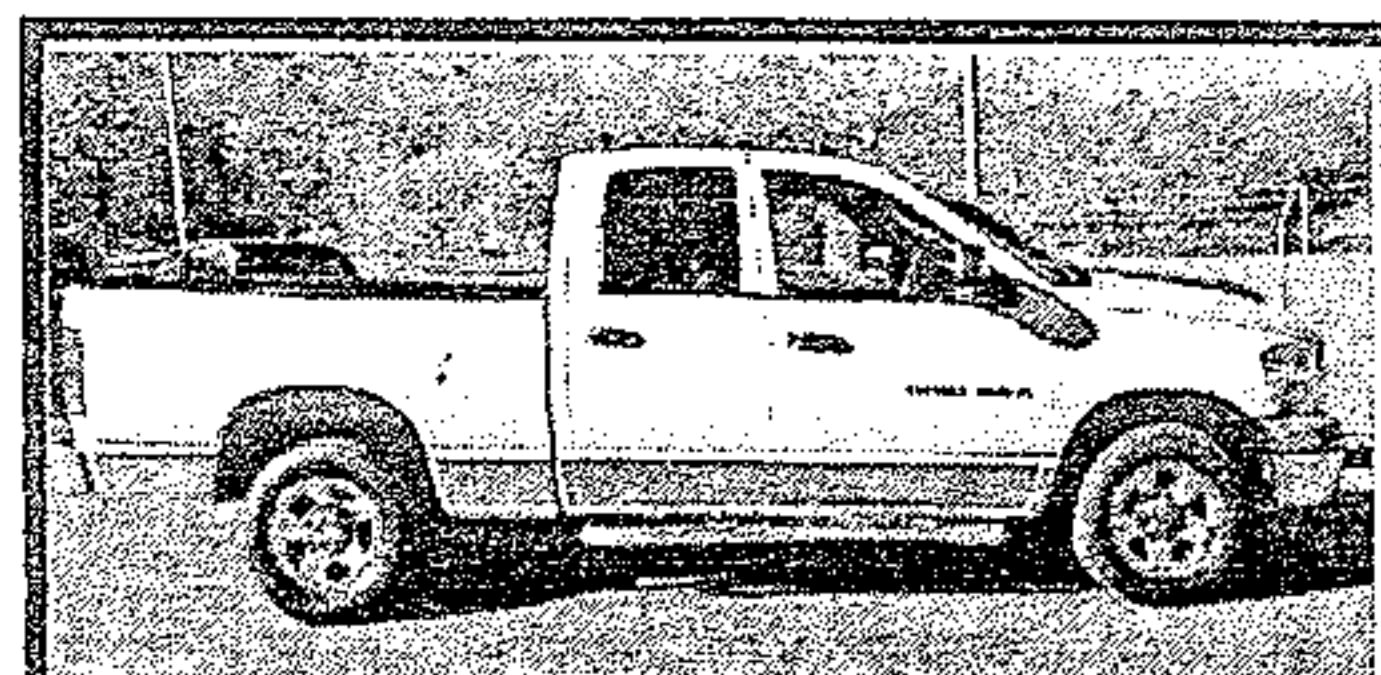

2010 Dodge Ram, 4dr, Great Work Truck, lots of room

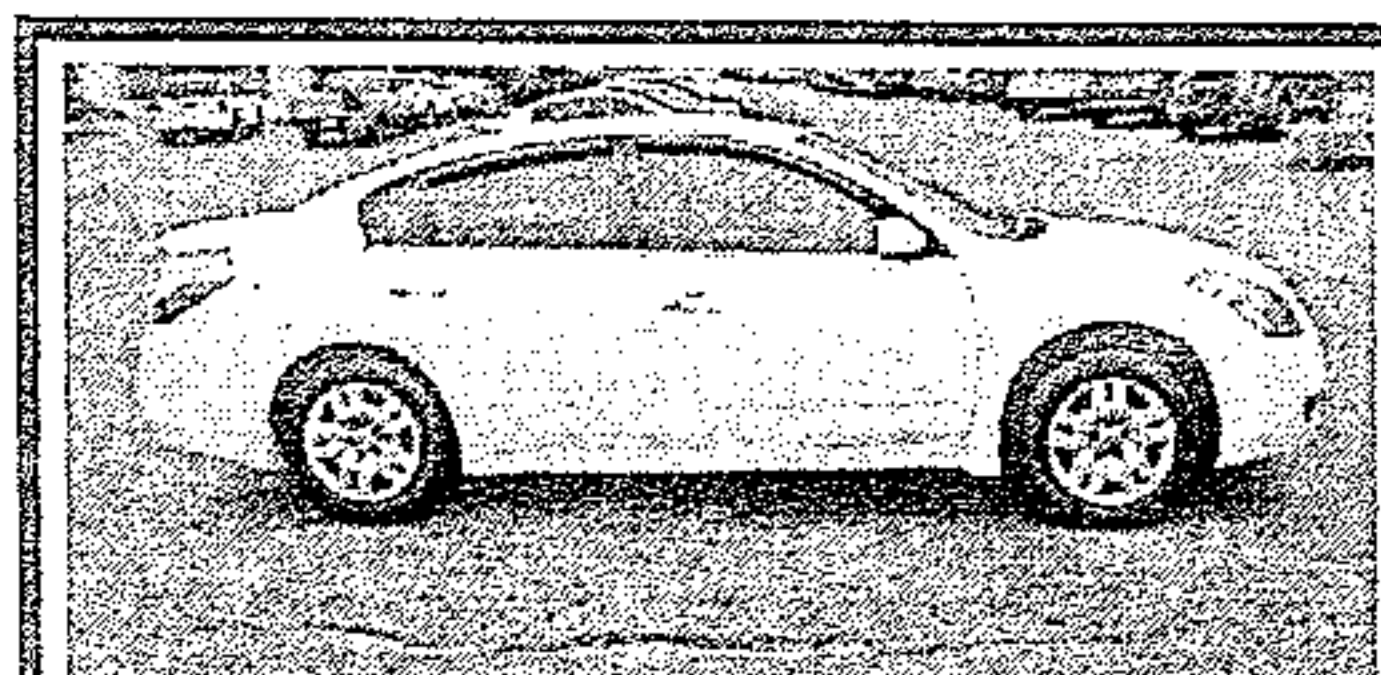

2009 Nissan Altima, LOADED, Super Nice Sporty Ride



2007 Suzuki Grand Vitara, V6, Nice!

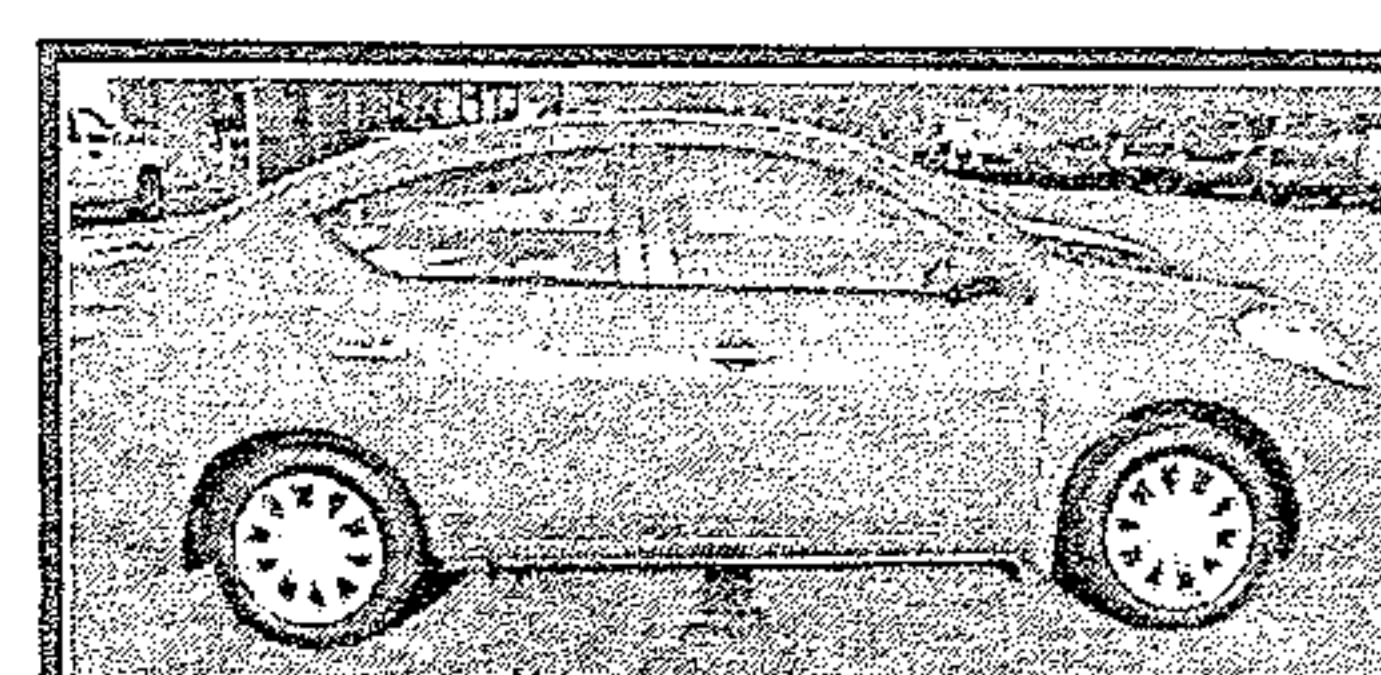

2013 Nissan Versa, Like New! LOADED!!!

WALT WILLIAMS, INC.

*with approved credit

3003 Highway 11

Lenoir City, TN

865-986-1111