

The Daily Edition

50¢

Serving Loudon, Monroe and Surrounding Counties

Monday, November 2, 2015

Burglary and theft of property reported

Deputy Chris Bowen LCSO, responded to Steekee Road to a burglary and theft from a barn. Upon arrival Deputy came in contact with the victim who stated he left to go out of town and returned to the barn and discovered someone had made entry to the barn and taken items. The items taken 10 Makita circular saw, 1

(see offense pg. 3)

Trespasser charged in philly is sex offender

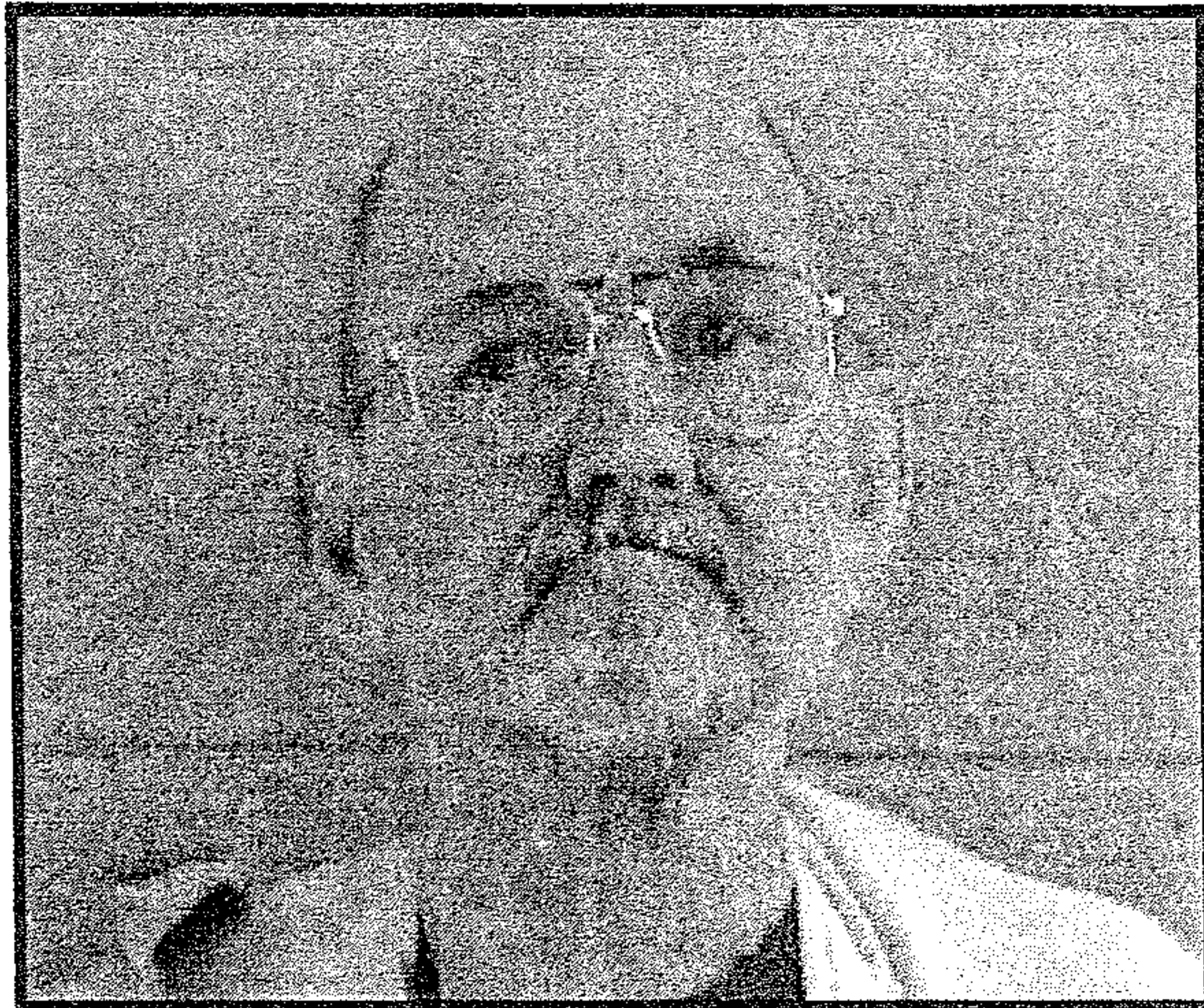

Billy Walker

(see charged pg. 2)

Financial Fraud

Inside the Investigation of a Las Vegas Construction Boss

When a federal judge sentenced former Las Vegas construction boss Leon Benzer to nearly 16 years in prison in August, it marked a final chapter in a \$58 million fraud scheme that took investigators nearly a decade to unravel.

Over a period of many years, Benzer brazenly sought to gain control of numerous condominium homeowners associations

(HOAs) in the Las Vegas area to secure lucrative construction and other contracts for himself and additional conspirators. To date, 44 individuals, including numerous state officials, have been convicted of crimes in connection with the fraud—which has been described as one of the largest public corruption cases in Nevada history.

“This case repre-

(see FBI pg. 5)

Delivery van maker sets up shop in Loudon, bringing up to 500 jobs

Governor Bill Haslam along with local officials joined executives and customers of delivery van maker Morgan Olson LLC Thursday to celebrate the opening of a new manufacturing facility in Loudon.

The opening of the facility in Loudon -- expected to create 400 jobs initially and 500 or more over the next

few years -- is evidence Tennessee is able to attract the most-advanced manufacturing companies, Haslam said.

Morgan Olson could go a lot of places, he said. Having the right workforce, especially an educated one, will continue to make the difference in recruiting such companies to the state, he said.

Haslam praised the company for having the desire to invest in the facility.

Company executives agreed that Loudon was the ideal location for several reasons, including the geographic proximity to key suppliers and highway infrastructure.

The new facility will feature the most-efficient manufacturing

(see jobs pg. 7)

Guns and money stolen in aggravated burglary

Deputy Jeremy Garland LCSO, was dispatched to Dailey Ave in reference to a burglary. Upon arrival Deputy made contact with the victim, who stated to Deputy that his family went to Knoxville around 18:30 and returned around 00:45 to find their home had been broken into. Victim stated the only thing

missing was an aluminum safe that was in his room. Victim advised Deputy that the safe contained 3 firearms, a tablet, camera, a bag filled with coins, and \$3400 in cash. Victim does own a large pit bull, which was inside the home at the time of the invasion. Victim stated who ever broke in had to be familiar with the dog or it

(see burglary pg. 4)

Verse of the Day

Woe to those who go to great depths to hide their plans from the LORD, who do their work in darkness and think, “Who sees us? Who will know?” — Isaiah 29:15

Obituaries

see inside **Wazzup**

A Big Shout Out To Master Donuts, it's hard to just eat only one so ya better go ahead and make it a dozen, thanks!

Weather

Today: A steady rain in the morning. Showers continuing in the afternoon. High 69F.
Tonight: A few clouds. Low around 55F.
Tuesday Sunshine and clouds mixed. High 74F.

Tuesday Night Partly cloudy skies. Low near 55F.

Horoscopes

Scorpio 10/23-11/21

You may be obsessing about issues of integrity today, yet the current cir-

(Continued on page 6)



charged

Billy Walker, 63, Homeless, was charged with Criminal Trespass. Deputy Ronnie Reagan LCSO, was dispatched to Nelson Street Philadelphia to an unwanted person at this residence.

The complainant told dispatch that the white male identified as Billy Walker is

a sex offender and was not wanted there and has been told that.

Cpl. Branam had also warned Billy not to be back on the property. Billy stated that he was homeless and was living under a bridge in Knoxville. Billy was taken into custody.

Deputy Ronnie Reagan LCSO, made the arrest.

To Get a Burning Permit:

Loudon (865) 986-8395
 Monroe (423) 442-7401
 Roane (865) 354-1054

**Call 865-771-2249 to Advertise and start saving today!
 Has your group got an event coming up?
 Let us know!!!**

Notice: The Daily Edition does not knowingly accept fraudulent or misleading materials. The Daily Edition cannot guarantee the validity of offerings or statements contained herein. All liability for the contents of all advertising, and for any claims that may arise therefrom, is the responsibility of the advertiser or its agency. The Daily Edition reserves the right to reject, edit, or abbreviate any advertisement submitted. Advertising is accepted with the understanding that all liability for all copyright violations is the sole responsibility of the advertiser. Photographs, artwork and other copy submitted for publication is considered the sole property of the advertiser. The Daily Edition will make every effort but will not be liable for failure to publish and ad or for typographical and layout errors. All statements and information about highlights featured items, letters to the editor, herein are those solely given to the interviewer or writer and the Daily Edition assumes no responsibility of the accuracy or validity thereof. The Daily Edition will gladly reprint at no charge that part of an advertisement in which an error occurs provided a claim is made within 3 days of the first publication of the ad. Information contained in the Wazzup is received anonymously and the Daily Edition assumes no responsibility for information and reserves the right to edit or reject any and/or all submissions. The Daily Edition is a daily newspaper of general circulation in Loudon County defined under TCA 2-1-104(a)(13). The Daily Edition also serves Monroe, Knox, Anderson, Roane and Blount counties and serves 30,000 readers weekly. Send mail to PO Box 1240, Lenoir City TN 37771. 865-771-2249. email: dan1204us@yahoo.com
 The Daily Edition is Loudon County's premier public interest and paid advertising paper. The Daily Edition is produced and published daily Monday through Friday and is circulated throughout Loudon County and parts of Monroe and Knox Counties. Display advertising rates \$5.00 per column inch and quantity discounts available. Call for information on upcoming promotions and events.

HACIENDA Ayala's
Mexican Restaurant
 Market Dr. * Lenoir City (In Front of Food City)

Real Authentic Mexican Food at Affordable Prices

BEST MARGARITA

You've Tried The Rest Now Come Have The Best!!!

We Accept ALL Competitors Coupons Outside of Mexico City!

986-3553



Good Credit OK • Bad Credit OK • Bankruptcies OK • Repo OK



2010 Kia Soul Sporty, 4 cyl, Auto, PW, PL, A/C, Great On Gas, Like New



2010 Ford Escape Limited Leather, Alloy Wheels, Heat, A/C, Luggage Rack, 79K,



2007 Dodge Ram 1500 Quad Cab, Thunder Road PKG, 20 in. Wheels, Low Miles, Hemi



2008 Ford Explorer 84k, 3rd Row Seating, Luggage Rack, Tow Pkg, PW, PL



2011 Ford Ranger Low Miles, Tow Pkg, New Tires, A/C, Heat, Bed Liner.



2011 Dodge Grand Caravan DVD, Stow & Go, Loaded, Remote Doors, Rear A/C

DEPENDABLE MOTORS 986-9343
803 E. Broadway • Lenoir City

Serving Loudon County for 20 Years

* WAC. See Dealer for details

Visit our website at: www.dependablemotorslc.com

offense

1/2 hp router, 3x24 portable belt sander, router and table, 16 in circular saw, 12 in radial arm mitre saw, schumaker battery charger, skil circular saw, extension cords, older aluminum craftman power tools, and there was an attempt to take a large planter, that was pulled to the door but was to heavy to load and left. The suspect made an attempt to re-secure the door by placing a shorter bolt through the hasp than was originally there.

Obituaries

Dorris Louise Lewis - age 85 of Loudon, TN passed away Thursday, October 29, 2015 at Parkwest Medical Center. Louise was a member of Calvary Baptist Church. She was preceded in death by her husband of 62 years, Elmer E. Lewis; parents, Taylor and Evelyn Riley; sister, Lois Jenkins, and an infant sister. Louise is survived by her daughter and son-in-law, Dorris and Robin Dale; sons and daughters-in-law, Steven and LeAnn Lewis, and Tony and Teresa Lewis all of Loudon; 10 grandchildren; 8 great grandchildren; brother, David Riley; sisters, Sandra Riley, Glenda Toney and Brenda Burton along with several nieces and nephews. The family will receive friends from 1 to 3 p.m. Sunday, November 1st at Click Funeral

Home Chapel in Lenoir City. Funeral services will follow at 3 p.m. with Dr. Dick DeMerchant officiating. Family and friends will gather for graveside services at 11 a.m. Monday morning in the Hillcrest Cemetery in Dandridge. Click Funeral Home, 109 Walnut Street, Lenoir City is in charge of arrangements.

Ruby Pearl Strange - age 82 of Lenoir City passed away Thursday morning, October 29, 2015 at her home. Ruby was a loving and devoted mother, grandmother and great-grandmother. She was a cook at Little Creek Sanitarium. Preceded in death by her husband, David Mack Strange; sons, Michael Strange and Loney Dean Strange; parents, James and Thelma Young; step-daughter, Betty Joe Strange; step-son, Bud Strange; grandsons, Scotty Wayne Strange and Marcus Wayne Strange; sister,

Lois Henry, brother, Jack Young; step-children, Maxine "Sis" Winston and son-in-law, Ralph Lawson. She is survived by her children and spouses, Ruben and Sue Strange, David and Shirley Strange, Gary Strange, Faye Brown, Ellen and Leroy Rice, Ricky and Pam Strange, Ann and Dean Rice, Phillip and Linda Strange, Roy Strange, Tony Strange, James Strange, Stacy and Stephanie Strange, and Caroline Strange; step-children, Anna Mae Lawson, George "Shug"

Strange, Jearl and Jim Arwood; many precious grandchildren, great-grandchildren and great-great grandchildren; several nieces and nephews. The family will receive friends from 5 to 7 p.m. Monday at Click Funeral Home in Lenoir City. Funeral services will follow at 7 p.m. with Rev. Don Acton officiating. In lieu of flowers, donations may be made to the funeral home to help with funeral expenses.

For Sale: oak Wood Mulch



Mushroom Compost Topsoil.



Firewood

Call Steve Spoon 986-4282

West End Storage & Warehouses
502 Ward Avenue • Loudon
Call 865-458-4774 or 865-679-5555



C&J Towing and Recovery
LOWEST TOWING RATES AROUND!!!

Have you been overcharged for any type of towing service in the Lenoir City area? If you have a breakdown or accident please **OWNER REQUEST C&J Towing** with the officer. Also please call your Sheriff and ask him to place C&J Towing on the "Rotation List*" and help other motorists save as much as you did! We at C&J are locally owned and operated, State approved, licensed, bonded and insured.

*note: the "Rotation List" is a list of wrecker services that provide service for wrecks, DUI's, breakdowns, etc. and are on an on-call basis for service. This list is approved by the Sheriff.

Cliff Teeters • Owner
865-809-1661

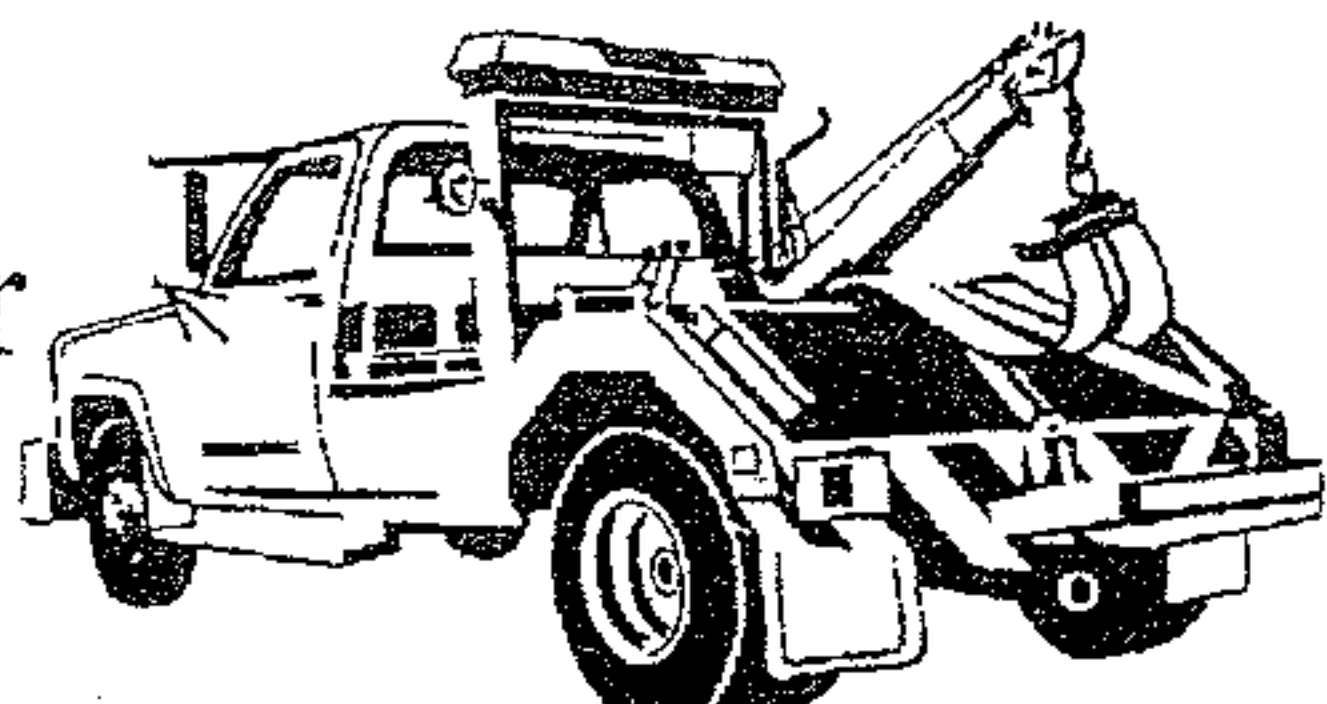

BIMBO'S
Deli Open 24 Hours
865-986-9643 Call Ins Welcome

Specials

Lg. Cold Sub, bag of chips and 16 oz. fountain drink only \$6.29

Footlong Corn Dog \$2.59

burglary would have attacked. Victim showed the Deputy where someone had cut a small hole into the front door to gain entry. A knife was found in the room that was consistent with the cut on the door with a name engraved on it. Victim did name 3 suspects. Items taken: black AR-15, black revolver, black Moss shotgun, Samsung Tablet, Polaroid Camera, Coach Wallet, with 140.00 dollars, black nike bag containing 200.00 in

change, 3400.00 cash, and the aluminum safe.

Loudon County Sheriff's Office Toys for Tots 2015

Thanks to the generosity year after year of the Loudon County residents, churches, businesses and industries, the Loudon County Sheriff's Office is once again able to offer the Toys for Tots program. We are beginning our 31st year of providing toys to the needy children of Loudon County, and thanks to generous contributions of time, money and gifts, we are able to make Christmas a more joyful time for more and more children.

In 2014, approximately 500 children were helped by the Loudon County Sheriff's Department Toys for Tots program through their partners. Even with the difficult economic times we are experiencing, we hope that the people of Loudon County will be there once again to help.

Names will be available beginning in mid-October through business and churches. If you are considering helping a child this Christmas, please be assured that applicants are thoroughly checked to make sure they require this assistance. Names are also compared with

the school systems to make sure no one is receiving duplicate assistance.

If your business or church would be willing to take names please call Debbie Hines, Toys for Tots Coordinator at 986-4823.

Police beat

Angelia Copeland, 37, McArthur Road Maryville, was charged with Public Intoxication. Deputy Bobby Ham-

ilton was dispatched to the Loudon Justice Center for a possible intoxicated person. Deputy Bobby Hamilton LCSO, arrested Angelia for PI.

Lesa McCulloch, 52, Monroe Street Madisonville, was charged with Failure to Appear. Deputy Brandon Dishner LCSO, served a FTA Warrant on Lesa at the Loudon Jail.

Purdy's Auto Sales
Hwy 11 Sweetwater
Buy Here Pay Here
Cars, Trucks, Vans, SUVs

SARCO Enterprises Inc. Offers Complete Home and Commercial Remolding and Repairs

Our Team members have a combined total of over 40 years experience in all areas of home construction, facilities maintenance and commercial construction. Roofing, Electrical, Bath and Kitchen Renovations, we do it all with just one call. We are fully insured and our work is guaranteed.

Call us today for a free no obligation quote for your next project.
865-809-9492.

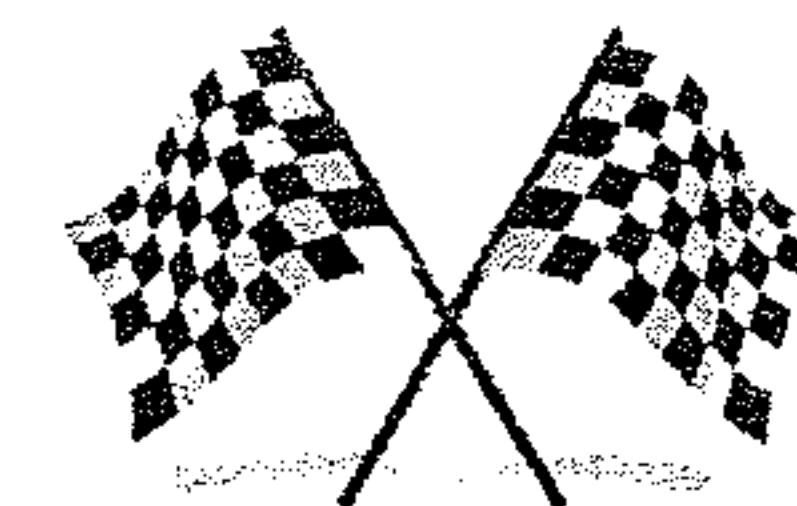

SOUTHERN AUTO DETAILING
414 WEST BROADWAY
LENOIR CITY, TN 37771
865-986-0724

Starting at \$34.95
Present this ad for \$5.00 off

Lenoir City Utilities Board
Gas Department

Pilot Lighting Season
2015

"Pilot Lighting Season" opens on October 1, 2015.
The cost for lighting a pilot light will be as follows:

1st Pilot Lighting, during normal work hours
No Charge

Pilot Re-lights, during normal work hours
\$25.00

After normal work hours/Holidays pilot lighting
\$141.56

Please call 986-6591, ext. 1720, to make an appointment for this service.

LGUB normal work hours are Monday – Friday,
7:00 am – 3:30 pm.

FBI

sented an incredibly complicated financial fraud with a significant public corruption component," said Special Agent Michael Elliott, who spent nearly eight years working on the investigation from the FBI's Las Vegas Division. "It involved so many people over so long a period of time, it was like an intricate spider web of crime that kept expanding."

The scheme was

nothing if not grandiose. In attempting to control dozens of Nevada HOAs between approximately 2002 and 2009, Benzer, an attorney, and other conspirators recruited straw buyers to purchase condominiums and then secure positions on HOA boards of directors. Benzer rigged HOA board elections and paid board members to take actions favorable to his interests—including

hiring his co-conspirator's law firm to handle construction-related litigation and awarding profitable construction contracts to Benzer's company, Silver Lining Construction.

Benzer manipulated and bribed HOA boards in a variety of ways—he often claimed he had local judges and law enforcement in his pocket; in other cases, he fooled unwitting homeowners

into thinking his actions were legitimate and they were simply making wise investment choices.

In September 2008, investigators executed a search warrant—one of nine that would take place during the investigation—and found that Benzer was in the process of targeting well over 20 different HOAs for illegal takeovers. "There were boxes and boxes of folders with infor-

mation about different HOAs," Elliott said. "He was deliberately attempting to identify board members along with other information to target what he believed were HOAs vulnerable to takeover through bribery, extortion, or whatever illegal means could be used."

One of the HOAs had more than 700 units, with each owner paying community fees, Elliott said. "In some cases, HOA boards had operating budgets larger than some small Nevada cities. There was lots of money at stake," he added.

The FBI, along with investigators from the Las Vegas Metropolitan Police Department and Internal Revenue Service - Criminal Investigations, used a variety of investigative techniques—including confidential sources, multiple undercover operatives, and forensic accountants—and conducted hundreds of interviews to piece together the extent of the crimes committed by Benzer and his co-conspirators.

In January 2015, Benzer pled guilty to multiple counts of conspiracy to commit mail and wire fraud and tax evasion. In addition to his 188-month jail term, he was ordered to pay more than \$13 million in restitution.

"This was a very sophisticated scam that evolved over time and generated millions of dollars for Benzer," Elliott said, adding that when Benzer was riding high, the charismatic fraudster employed "an army of lawyers, had bodyguards, and had an entourage that included three armored SUVs."

(see FBI ctd. pg. 8)

PURDY'S AUTO PARTS AND SALVAGE
WE BUY SCRAP IRON • COPPER • BRASS • ALUMINUM

\$

Paying Top \$\$\$
 Call For Latest Prices

You Name It, We Buy It!

Radiators, Wheels, Batteries, Appliances, Farm Equipment

Copper
 Paying Top \$\$\$
 Call For Latest Prices

Complete Cars
 per 100 lbs.

Scrap Metal
 Paying Top \$\$\$
 Call For Latest Prices
 per 100 lb

We Buy Batteries

Aluminum Cans
 Paying Top \$\$\$
 Call For Latest Prices

You Call We Haul!
423-519-5402

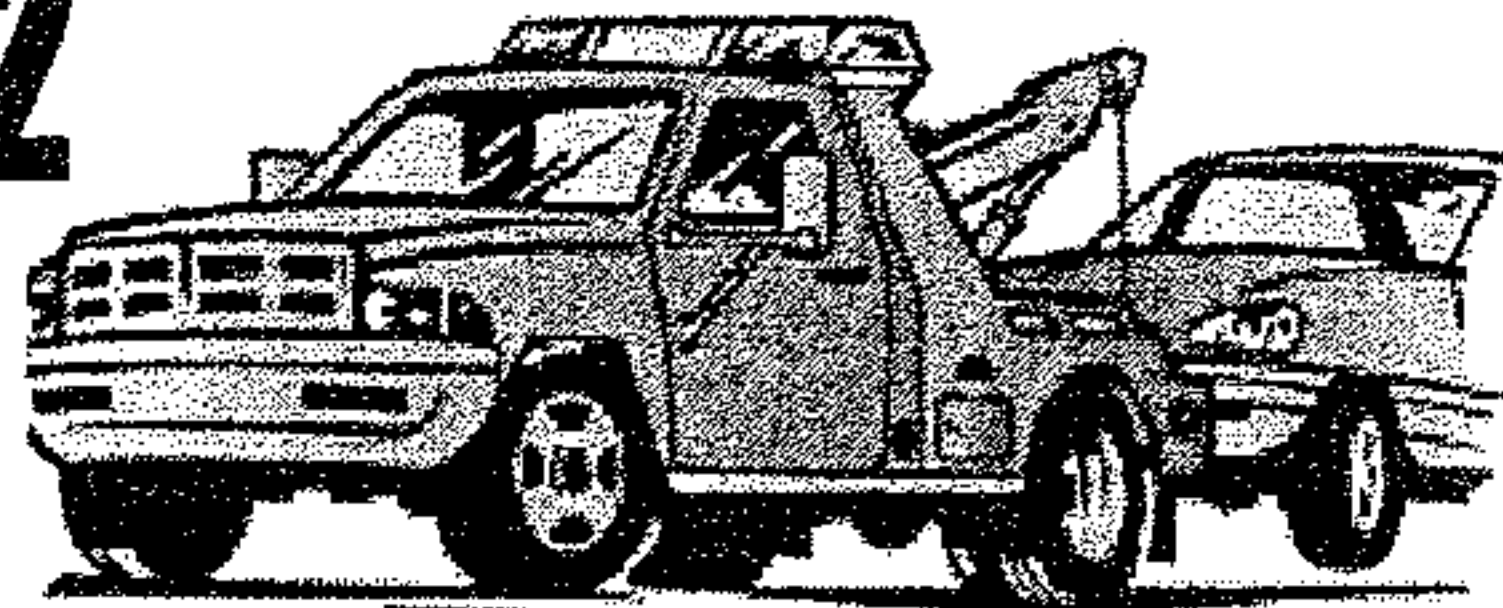

Prices subject to change with the market.

Now Selling Aftermarket Body Parts at Discount Prices

423 337-3977

149 County Road 323 Sweetwater

Prices subject to change with the market.

jobs

technologies available. The facility has more than 300,000 square feet of production space and the company plans to make every square foot functional, efficient and safe.

The plant was the former manufacturing site for John Deere and most recently, Astec Industries, which left the building empty in April.

Pat Phillips, ex-

ecutive director of the Loudon County Economic Development Agency, said it was important to get the building back into use.

Phillips said the addition of such a high-profile company to the area could help recruiting more businesses to the Innovation Valley.

James Robertson, a broker with NAI in Knoxville, closed the sale of the building for a reported \$10 million a few weeks ago. He

said the deal was partly a result of a mass-marketing effort to equipment manufacturers.

Steve Hart director of human resources for Morgan Olson, said the company's growth is being fueled by the need for lightweight, efficient delivery vehicles for companies such as UPS and FedEx.

The goal is to have the plant operational with about 150 employees at work by mid-January. By the end of 2016 200-300 employees will be hired. The company is looking for assemblers with experience riveting, painters, welders and machinists, he said.

County Mayor Bud-

dy Bradshaw said the recruitment of Morgan Olson is probably one of the most-important economic opportunities in the county's history. He pledged to continue to provide support in the future.

"We want you here and we want to keep you here," he told Morgan Olson executives at the event.

The county commission and the city council of Loudon voted earlier this week to provide a 10-year payment-in-lieu-of-taxes (PILOT) incentive

package to Morgan Olson.

Haslam confirmed that the state also provided incentives but could not provide specifics because details were still being worked out.

Morgan Olson LLC will be holding a job fair Nov. 5 at the new facility at 9600 Corporate Park Drive in Loudon's Matlock Bend Industrial Park, from 8 a.m. to 5 p.m. Key salaried positions are currently posted on the Morgan Olson website.

Public Notice

The County Corrections Partnership Committee will hold an open meeting at the Justice Center training room November 4, 2015 at 12 PM to discuss plans to move forward

If Your Washer Tore Up?
Call Me I Only Charge \$100 Period!!!
Call Allen 865-617-7113

LOOK! \$75 Weekly Payments LOOK!

MARTY'S AUTO SALES • 986-2222 • MARTY'S AUTO SALES • 986-2222 • MARTY'S AUTO SALES • 986-2222 • MARTY'S AUTO SALES • 986-2222 • MARTY'S AUTO SALES • 986-2222 • MARTY'S AUTO SALES • 986-2222

Bad Credit
Divorce
Fixed Income
Repos
Bankruptcy
No Credit

APPROVED! **NO CREDIT CHECKS**

Visit Us On The Web At:
martysautosales.net

 <p>\$499 down*</p> <p>07 Cobalt, 5spd, gas saver, runs great Only \$499 down*</p>	 <p>\$499 down*</p> <p>02 Sable, sunroof, loaded, Only \$499 down*</p>	 <p>\$499 down*</p> <p>04 Cavalier, 2dr, Sporty, Only \$499 down*</p>	 <p>\$499 down*</p> <p>01 Sebring 2dr. sporty, Only \$499 down*</p>
 <p>\$299 down*</p> <p>97 Escort, auto, Gas Saver, Only \$299 down*</p>	 <p>\$499 down*</p> <p>03 Focus 5 speed, Gas Saver, Only \$499 down*</p>	 <p>\$399 down*</p> <p>01 Venture, 7 passenger, Runs Great Only \$399 down*</p>	 <p>\$499 down*</p> <p>00 Ram, High Top Conversion Van, Loaded only \$499 down*</p>

NO Credit Checks **Marty's Auto Sales 986-2222** **100% Approval*** **Se Habla Espanol**

*See Dealer for details. All down payments plus tax, tag, title and fees.

MARTY'S AUTO SALES • 986-2222 • MARTY'S AUTO SALES • 986-2222 • MARTY'S AUTO SALES • 986-2222 • MARTY'S AUTO SALES • 986-2222 • MARTY'S AUTO SALES • 986-2222 • MARTY'S AUTO SALES • 986-2222

FBI ctd. from pg. 5

He had no problem spending money to maintain his lavish lifestyle."

But like many high-

flying scam artists, it was only a matter of time before Benzer was brought to justice. "Now he is in jail and penniless," Elliott said. "He has nothing."

Public Notice

The Loudon County Board of Education will hold an Executive Session to Discuss Pending Lawsuits and Claims on November 5, 2015 at 5:30 pm at the County Office Building.

LONNIE JONES OPTICAL DISPENSARY

"We Make The Difference You Can See"
Locally Owned and Operated

Over 1000 Frames To Choose From
No Frame Over \$69.00



On the corner of A & Depot Street, Lenoir City

986-7803

Serving Loudon County for over 40 years

A Name You Already Know And Trust Just Got Even More Dependable
DEPENDABLE AUTO SERVICE, LUBE AND TIRES
is Now Offering
Expert, Affordable Transmission Service

All ASE Certified Technicians

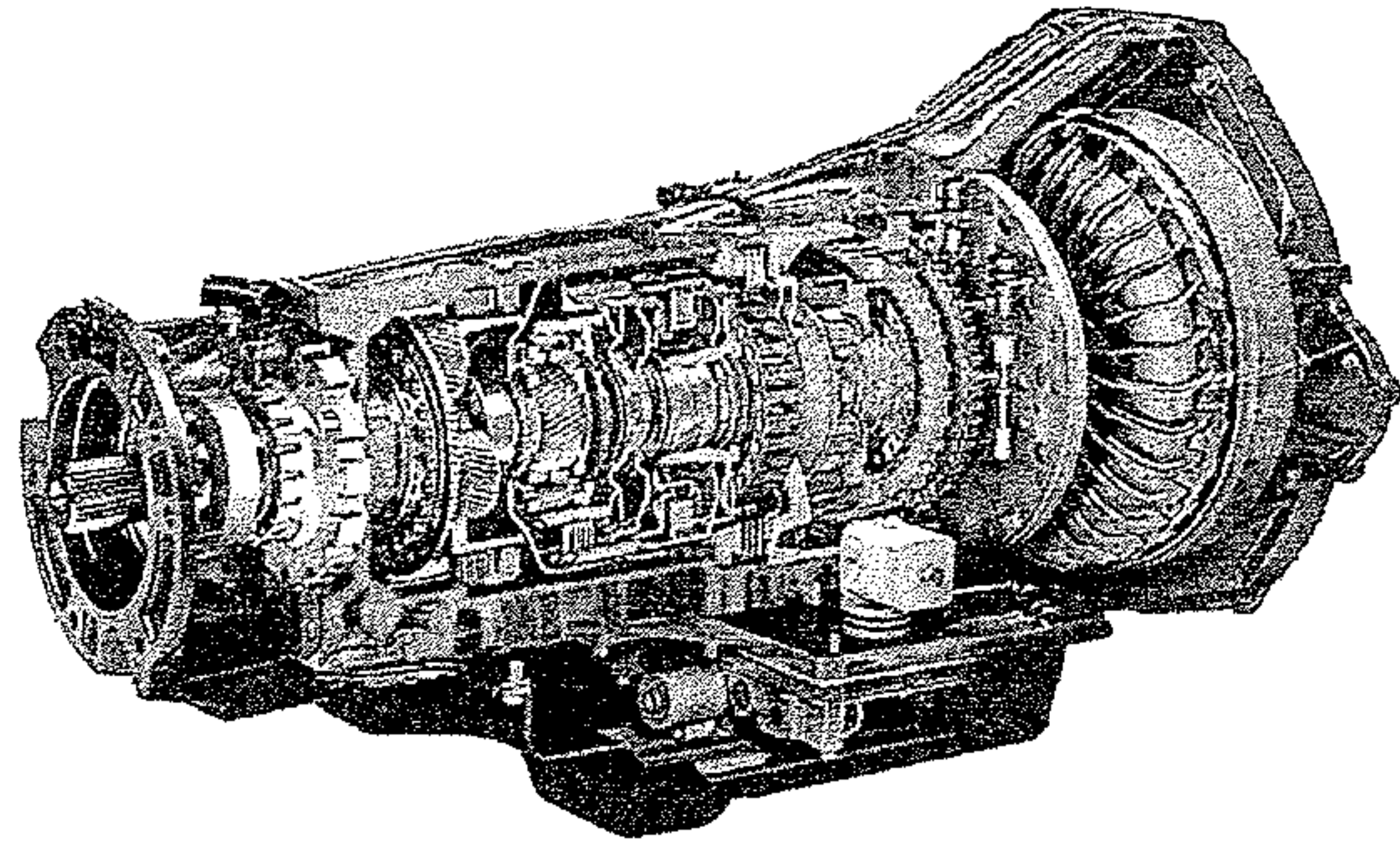

We proudly welcome all New Customers and Former Advanced Transmission Customers with a 10% Discount and Any Transmission Service or Repair*

865-986-9359

865-986-5050

Bad Credit, No Credit OK!!! We Finance Everybody!!!
Low Down Payment!!!

Over 100 Cars, Trucks & Vans in Stock - Warranties On ALL Vehicles Sold!!!



2009 Chevy Work Truck, Nice, lots of storage

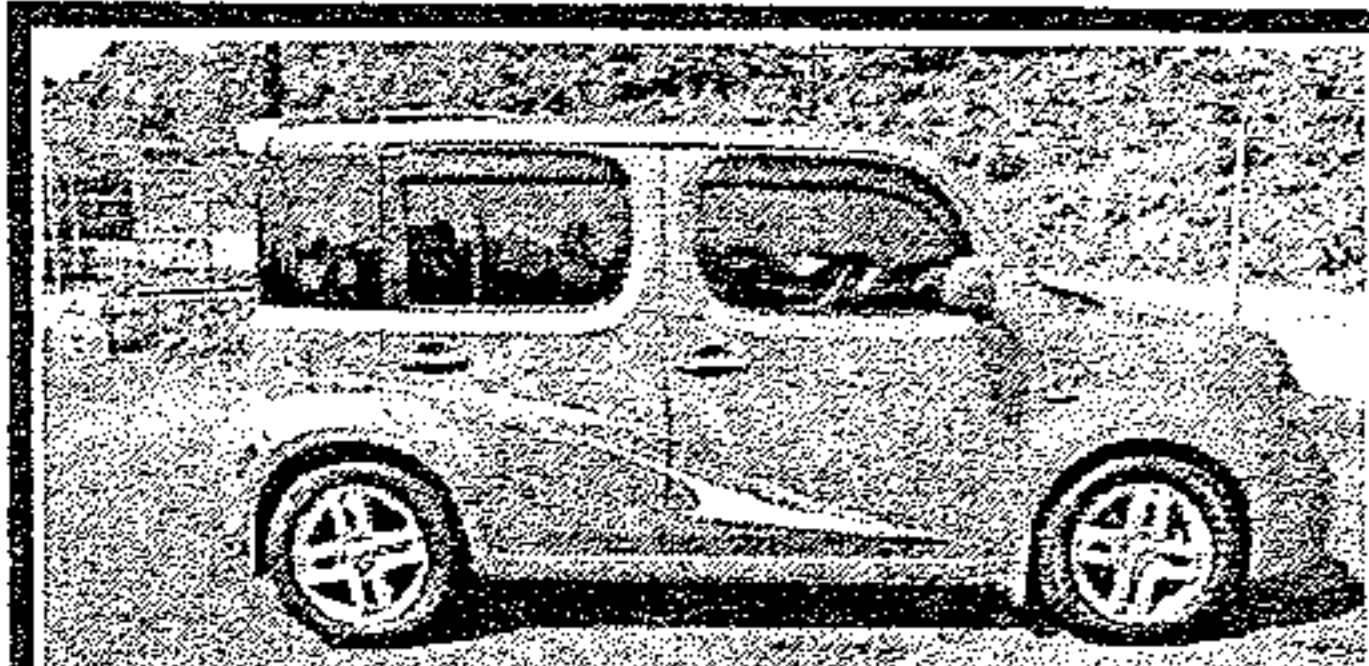

2009 Nissan Cube, 66k miles, Great Gas Saver,



2006 Rendevous, leather, 3rd row seat

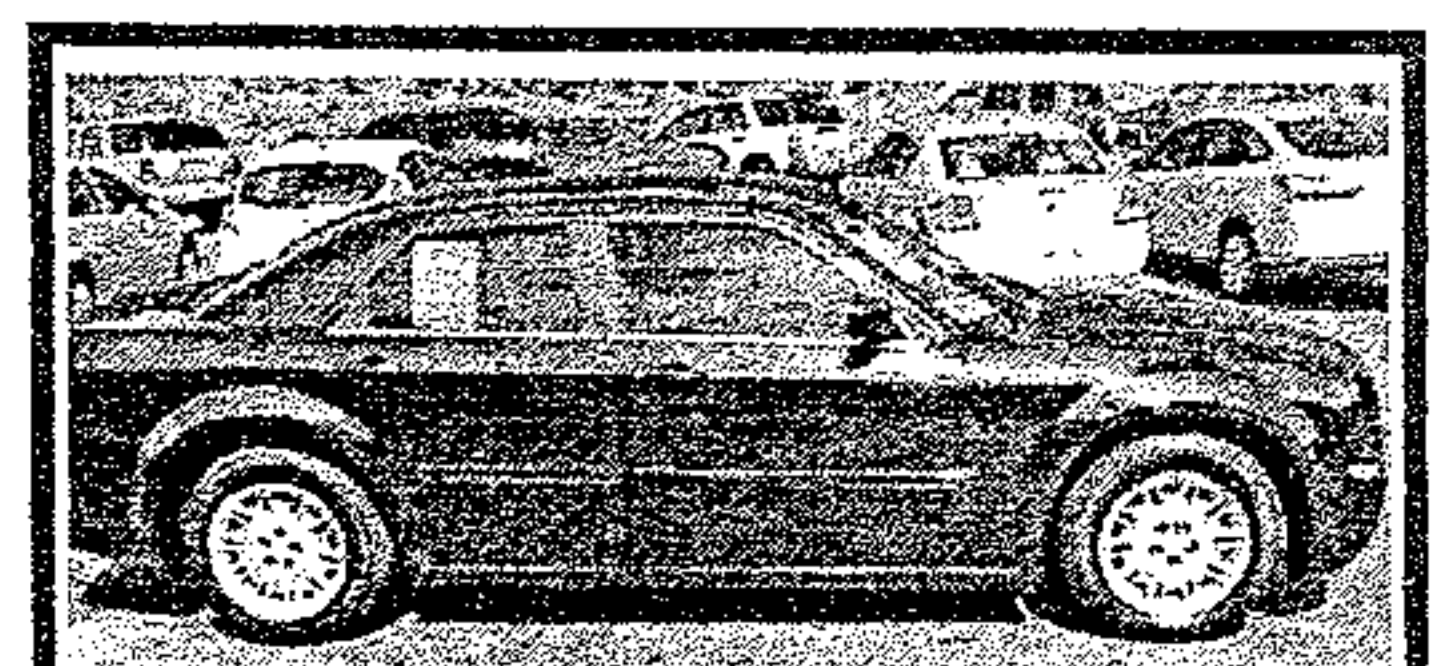

2006 Chrysler 300, Loaded, Nice Ride

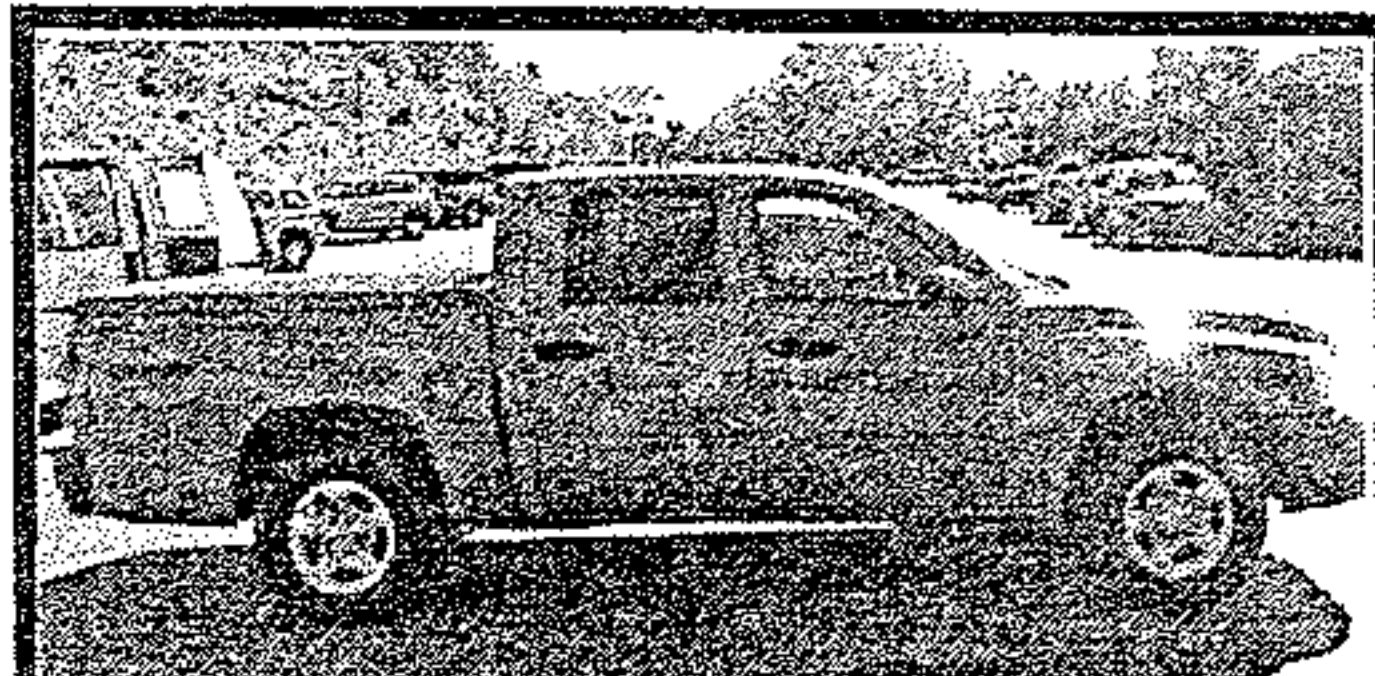

2005 Dodge Dakota, 4dr, 4x4, Extra Clean, lots of room



2011 Chevrolet Cruze, 55k miles, LOADED!!!



2007 Suzuki Grand Vitara, V6, 66k miles, Nice!

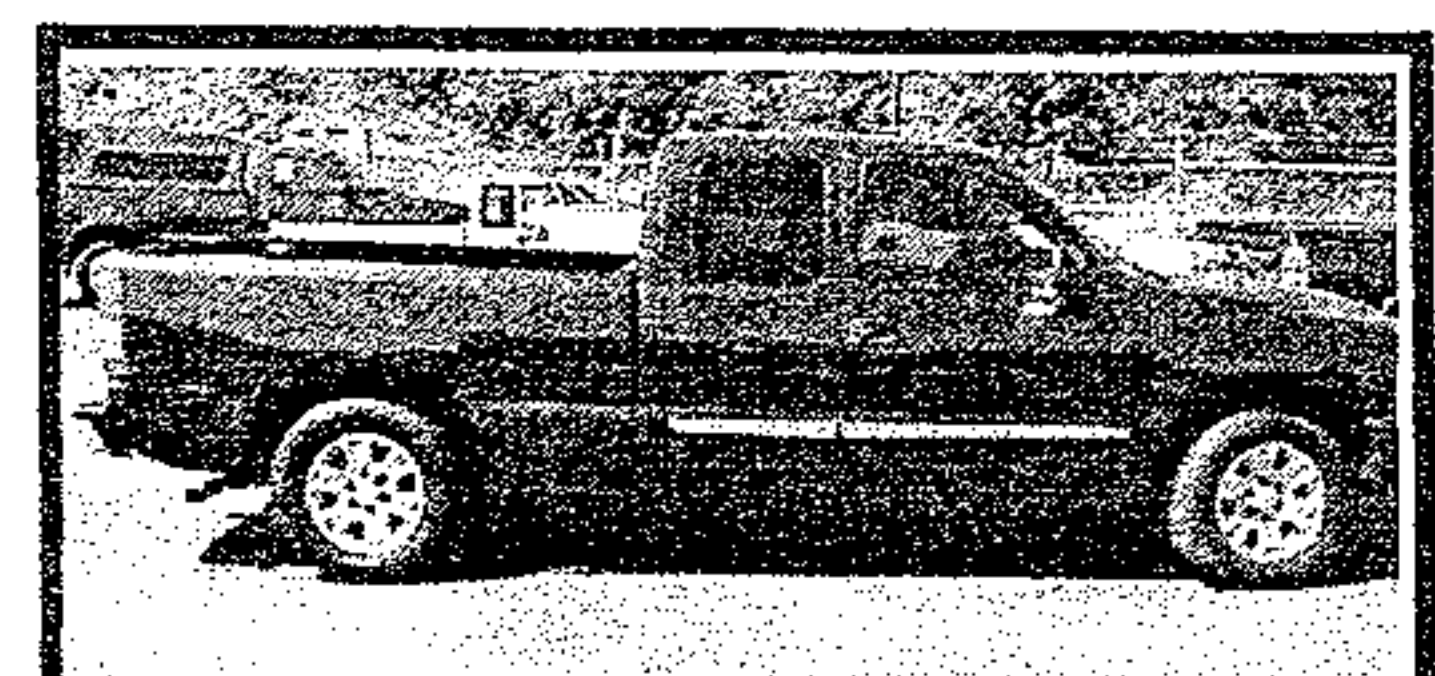

2006 GMC 1500 Ex. Cab, Clean ride

WALT WILLIAMS, INC.

*with approved credit

3003 Highway 11

Lenoir City, TN

865-986-1111