

# The Daily Edition

50¢

Serving Loudon, Monroe and Surrounding Counties

Wednesday, November 18, 2015

## Charged after leaving wreck scene



Thomas Russell  
(see wreck pg. 3)

## Mark Lowry draws crowd to First Baptist LC



Mark Lowry shares one of his hilarious stories with his one of a kind facial expressions that says it all  
(see Lowry pg. 2)

## Speeding stop ends with charges for LC man



James Drake  
(see stop pg. 5)

## DUI driver charged with vandalism following wreck call

Thomas Black, 23, Vingar Ridge Road Madisonville, was charged with DUI, and Vandalism. Officer Brandon Nix LPD, was dispatched to River Oaks for a possible wreck. Upon arrival Officer made contact with both drivers one identified as Thomas Black. The other driver stated he witnessed a BMW driving on the sidewalk on the wrong

(see vandalism pg. 7)



Thomas Black

## Latest Hate Crime Statistics Available

Report Contains Info on Offenses, Victims, and Offenders

According to the FBI's latest report, law enforcement agencies reported 5,479 hate crime incidents involving 6,418 offenses to our Uniform Crime Reporting (UCR) Program in 2014. And these crimes—which often have a devastating impact on the communities where they occur—left 6,727 victims in their wake.

The latest figures are

down from 2013, when 5,928 criminal incidents involving 6,933 offenses were reported.

Hate Crime Statistics, 2014 provides information about the offenses, victims, and offenders. Among some of the highlights:

Of the 5,462 single-bias incidents reported in 2014, 47 percent were racially motivated. Other motivators included sexual orientation, reli-

(see FBI pg. 4)

### Verse of the Day

I am suffering ... Yet I am not ashamed, because I know whom I have believed, and am convinced that he is able to guard what I have entrusted to him for that day. — 2 Timothy 1:12

### Obituaries

see inside **Wazzup**

Get ready for the cold weather afraid it's here. If you are making plans for the weekend plan some extra time.

### Weather

Today: Overcast skies with heavy rain likely in the afternoon. Thunder possible. High near 70F. Tonight: Rain ending early. Partial clearing late. Thunder possible. Low 49F. Thursday Sun and a few

passing clouds. High 66F. Thursday Night Clear skies. Low near 40F.

### Horoscopes

Scorpio 10/23-11/21 You must be methodical in your communication today or your plans may

(Continued on page 6)



3 08805 93489 2

**Lowry**

This past week, Mark Lowry, world renowned Christian singer formerly with the Gaithers brought his Music and Madness to Lenoir City. First Baptist Church of Lenoir City hosted the event and did so in perfect fashion.

Sound was perfect as was the message shared by Mark and the also world renowned Martins. Stan Whitmire also accompanied the groups.

The pews were packed at FBLC as the show began with the Martins who were joined by Mark Lowry to open it up. It never slowed

down as they all sang and shared a valuable message of salvation for us all and that message is Jesus is the Great I AM!

VIP ticket holders were treated to a meet and greet (see ML ctd. pg. 3)

**Notice**  
 Vin 1G82557N87F202859  
 General Motors Vehicle will be sold. If anyone has a lien on this vehicle contact: Homer's Body Shop, 10609 Beals Chapel Road, Lenoir City, 37772, 865-388-0372.

**Notice:** The Daily Edition does not knowingly accept fraudulent or misleading materials. The Daily Edition cannot guarantee the validity of offerings or statements contained herein. All liability for the contents of all advertising, and for any claims that may arise therefrom, is the responsibility of the advertiser or its agency. The Daily Edition reserves the right to reject, edit, or abbreviate any advertisement submitted. Advertising is accepted with the understanding that all liability for all copyright violations is the sole responsibility of the advertiser. Photographs, artwork and other copy submitted for publication is considered the sole property of the advertiser. The Daily Edition will make every effort but will not be liable for failure to publish and ad or for typographical and layout errors. All statements and information about highlights featured items, letters to the editor, herein are those solely given to the interviewer or writer and the Daily Edition assumes no responsibility of the accuracy or validity thereof. The Daily Edition will gladly reprint at no charge that part of an advertisement in which an error occurs provided a claim is made within 3 days of the first publication of the ad. Information contained in the Wazzup is received anonymously and the Daily Edition assumes no responsibility for information and reserves the right to edit or reject any and/or all submissions. The Daily Edition is a daily newspaper of general circulation in Loudon County defined under TCA 2-1-104(a)(13). The Daily Edition also serves Monroe, Knox, Anderson, Roane and Blount counties and serves 30,000 readers weekly. Send mail to PO Box 1240, Lenoir City TN 37771. 865-771-2249. email: dan1204us@yahoo.com  
 The Daily Edition is Loudon County's premier public interest and paid advertising paper. The Daily Edition is produced and published daily Monday through Friday and is circulated throughout Loudon County and parts of Monroe and Knox Counties. Display advertising rates \$5.00 per column inch and quantity discounts available. Call for information on upcoming promotions and events.



from left: the Martins, Stan Whitmire, and Mark Lowry hugs Mary Bell during the VIP visit

**Good Credit OK • Bad Credit OK • Bankruptcies OK • Repo OK**



2010 Kia Soul Sporty, 4 cyl, Auto, PW, PL, A/C, Great On Gas, Like New



2010 Ford Escape Limited Leather, Alloy Wheels, Heat, A/C, Luggage Rack, 79K,



2007 Dodge Ram 1500 Quad Cab, Thunder Road PKG, 20 in. Wheels, Low Miles, Hemi



2008 Ford Explorer 84k, 3rd Row Seating, Luggage Rack, Tow Pkg, PW, PL



2011 Ford Ranger Low Miles, Tow Pkg, New Tires, A/C, Heat, Bed Liner.



2011 Dodge Grand Caravan DVD, Stow & Go, Loaded, Remote Doors, Rear A/C

**DEPENDABLE MOTORS 986-9343**  
 803 E. Broadway • Lenoir City

Serving Loudon County for 20 Years

\* WAC. See Dealer for details

Visit our website at: [www.dependablemotorslc.com](http://www.dependablemotorslc.com)

ML ctd. from pg. 2

with the performers and a question and answer session as well as private photo op. FBLC sure knows how to to

do it up right.

A special thanks to all the staff of FBLC and the volunteers who helped bring this great event to fruition with great organization.



A packed house enjoyed every minute of the show at First Baptist Lenoir City. This was just one of several standing ovations the performers received throughout the night.

wreck

Thomas Russell, 27, Kingston Hwy, Lenoir City, was charged with Leaving the Scene of an Accident. Deputy Garland LCSO, was dispatched to a accident where the complainant stated the vehicle had rolled over. Upon arrival a witness to the accident stated that a white male climbed out of

the vehicle. Witness stated he ask the driver if he was ok and ask his name. The driver stated he was not injured and his name is Thomas. The witness contacted 911 and the driver stated he could not get caught with the vehicle and ran into the woods. After further investigation, and open and un-open beer bottles were located in the vehicle, (see wreck ctd. pg. 5)

**West End Storage & Warehouses**  
**502 Ward Avenue • Loudon**  
**Call 865-458-4774 or 865-679-5555**

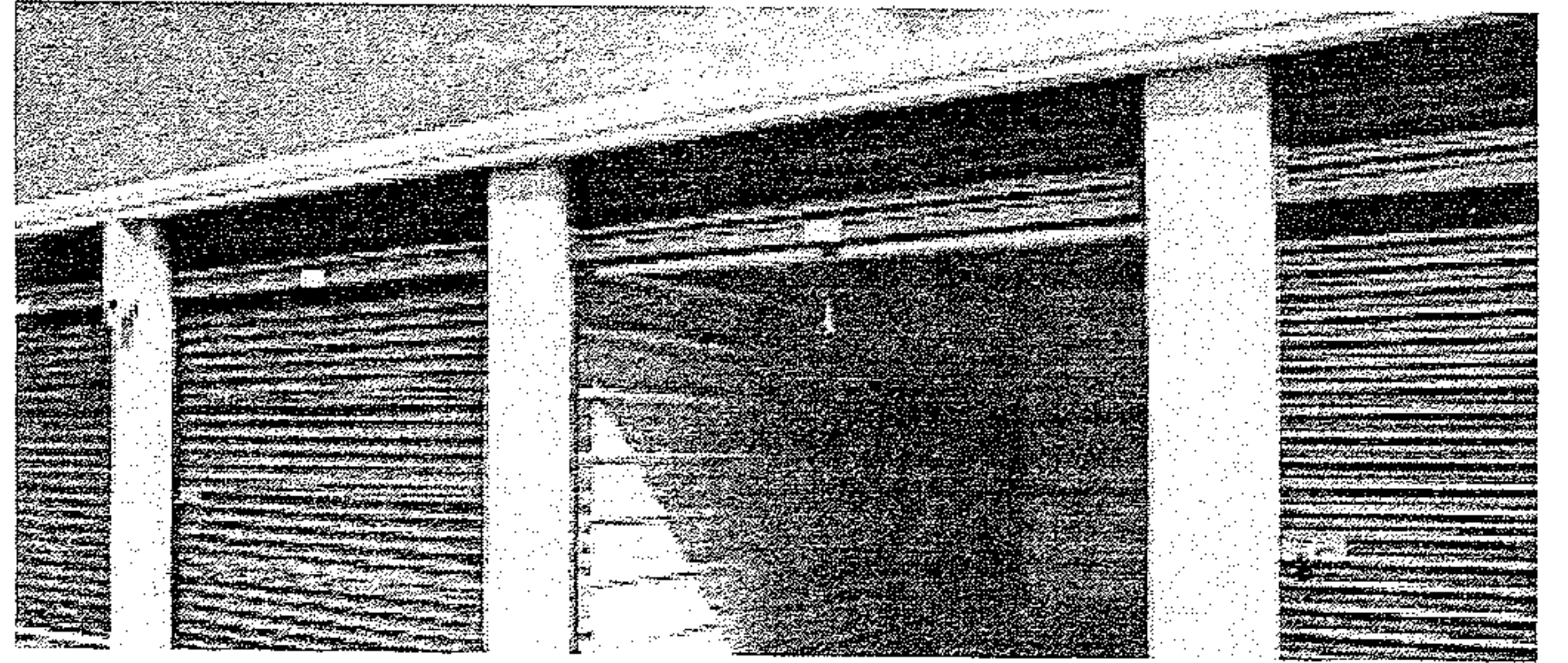

**C&J Towing and Recovery**

**LOWEST TOWING RATES AROUND!!!**

Have you been overcharged for any type of towing service in the Lenoir City area? If you have a breakdown or accident please OWNER REQUEST C&J Towing with the officer. Also please call your Sheriff and ask him to place C&J Towing on the "Rotation List\*" and help other motorists save as much as you did! We at C&J are locally owned and operated, State approved, licensed, bonded and insured. Call and let us know if your denied service or how we can be of assistance.

\*note: the "Rotation List" is a list of wrecker services that provide service for wrecks, DUI's, breakdowns, etc. and are on an on-call basis for service. This list is approved by the Sheriff.

Cliff Teeters • Owner  
**865-809-1661**

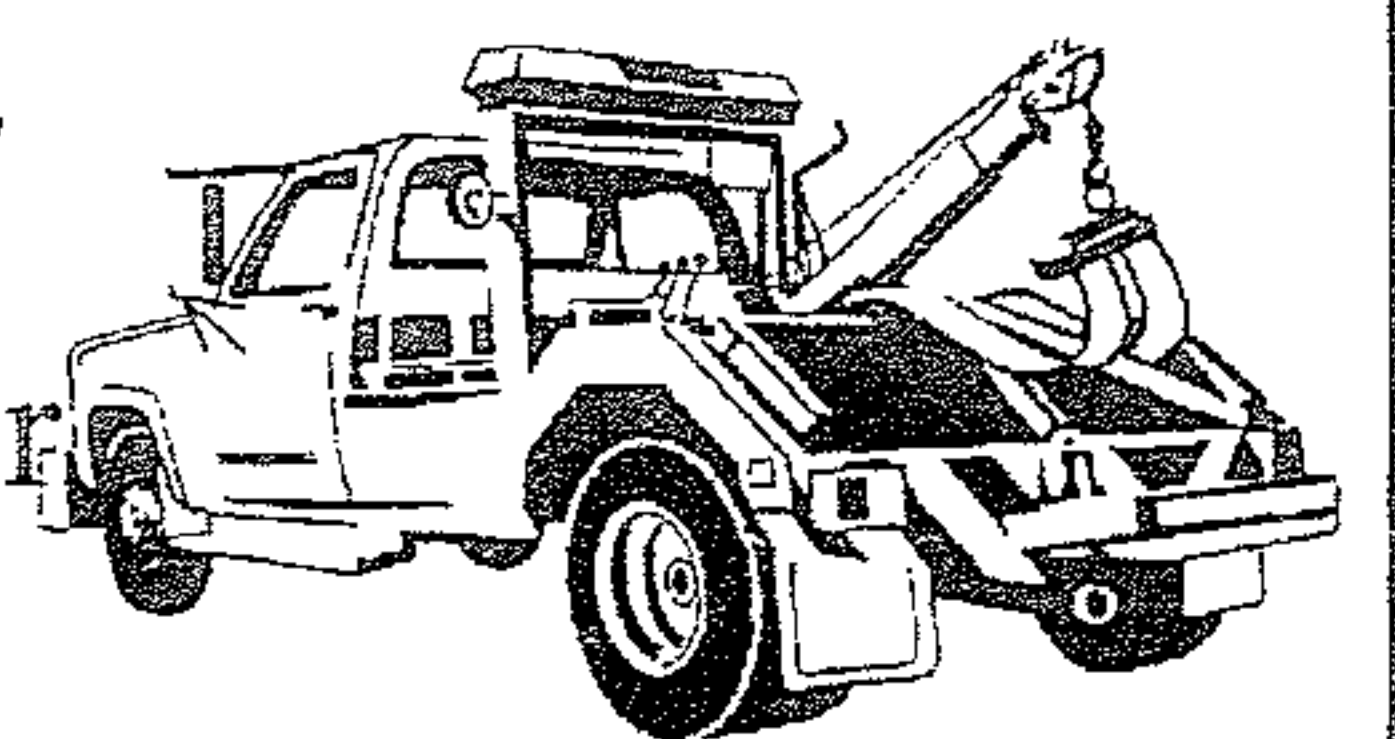

**HACIENDA Ayala's**

**Mexican Restaurant**

Market Dr. \* Lenoir City (In Front of Food City)

**Real Authentic Mexican Food at Affordable Prices**

**BEST MARGARITA**

You've Tried The Rest Now Come Have The Best!!!

We Accept ALL Competitors Coupons Outside of Mexico City!  
 986-3553



**BIMBO'S**

**Deli Open 24 Hours**

**865-986-9643 Call Ins Welcome**

**Specials**

**Lg. Cold Sub, bag of chips and 16 oz. fountain drink only \$6.29**

**Footlong Corn Dog \$2.59**

**FBI**

gion, ethnicity, gender identity, disability, and gender.

-Of the 6,418 reported hate crime offenses, 63.1 percent were crimes against persons and 36.1 percent were crimes against property. The remaining offenses were crimes against society, like illegal drug activity or prostitution.

-The majority of the 4,048 reported crimes against persons involved intimidation (43.1 percent) and simple assault (37.4 percent).

-Most of the 2,317 hate crimes against property were acts of destruction, damage, and vandalism (73.1 percent).

-Individuals were overwhelmingly the most common victim of a single-bias hate crime, accounting for

82.4 percent of the reported 6,418 offenses. The remaining victim types were businesses, financial institutions, religious organizations, government, and society or the public.

-Also during 2014, law enforcement agencies reported 5,192 known offenders in 5,479 bias-motivated incidents. (In the UCR

Program, "known offender" does not imply that the suspect's identity is known, only that some aspect of the suspect was identified by a victim or witness—such as race, ethnicity, or age.)

And while 15,494 law enforcement agencies contributed to UCR's Hate Crime Statistics report in 2014, only

1,666 agencies reported hate crimes within their jurisdiction (the remaining agencies reported zero hate crimes).

To enhance the accuracy of hate crime reporting, representatives from the UCR Program participated in five hate crime training sessions provided jointly by the Department of Justice

(DOJ) and the FBI. Since April 2015, DOJ and the FBI provided the training sessions to law enforcement agencies and community groups in several different areas of the county. UCR personnel also worked with states to ensure proper data submission and met with (see FBI ctd. pg. 5)

**SARCO Enterprises Inc. Offers Complete Home and Commercial Remolding and Repairs**

Our Team members have a combined total of over 40 years experience in all areas of home construction, facilities maintenance and commercial construction. Roofing, Electrical, Bath and Kitchen Renovations, we do it all with just one call. We are fully insured and our work is guaranteed.

Call us today for a free no obligation quote for your next project.  
865-809-9492.

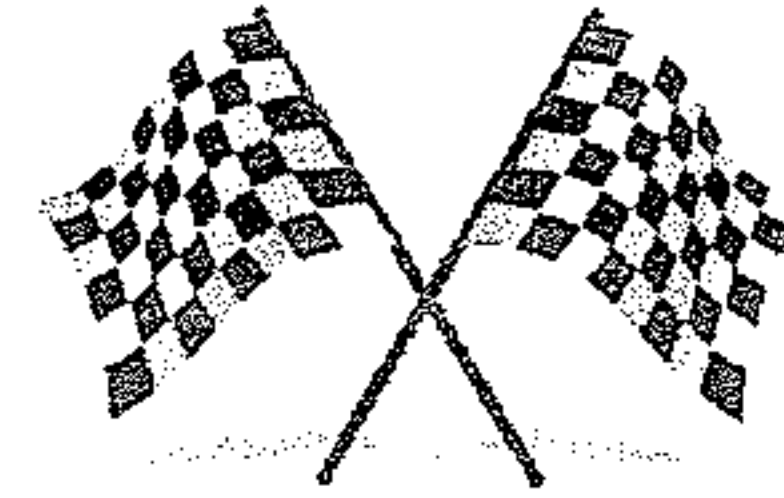

**SOUTHERN AUTO DETAILING**

**414 WEST BROADWAY**

**LENOIR CITY, TN 37771**

**865-986-0724**

**Starting at \$34.95**

**Present this ad for \$5.00 off**

**BUDGET**  
*Transmissions*

**302 S. Northshore Drive Knoxville**

**(865) 584-4391**

**Why Buy From Budget?**

**Free Towing From Lenoir City or Loudon County**

**20 Years of BBB Zero Customer Complaints Award Member**

**A+ Plus Rated**

**Huge Transmission Inventory Best Technicians Period!!!**

**Call (865) 584-4391 Today!**

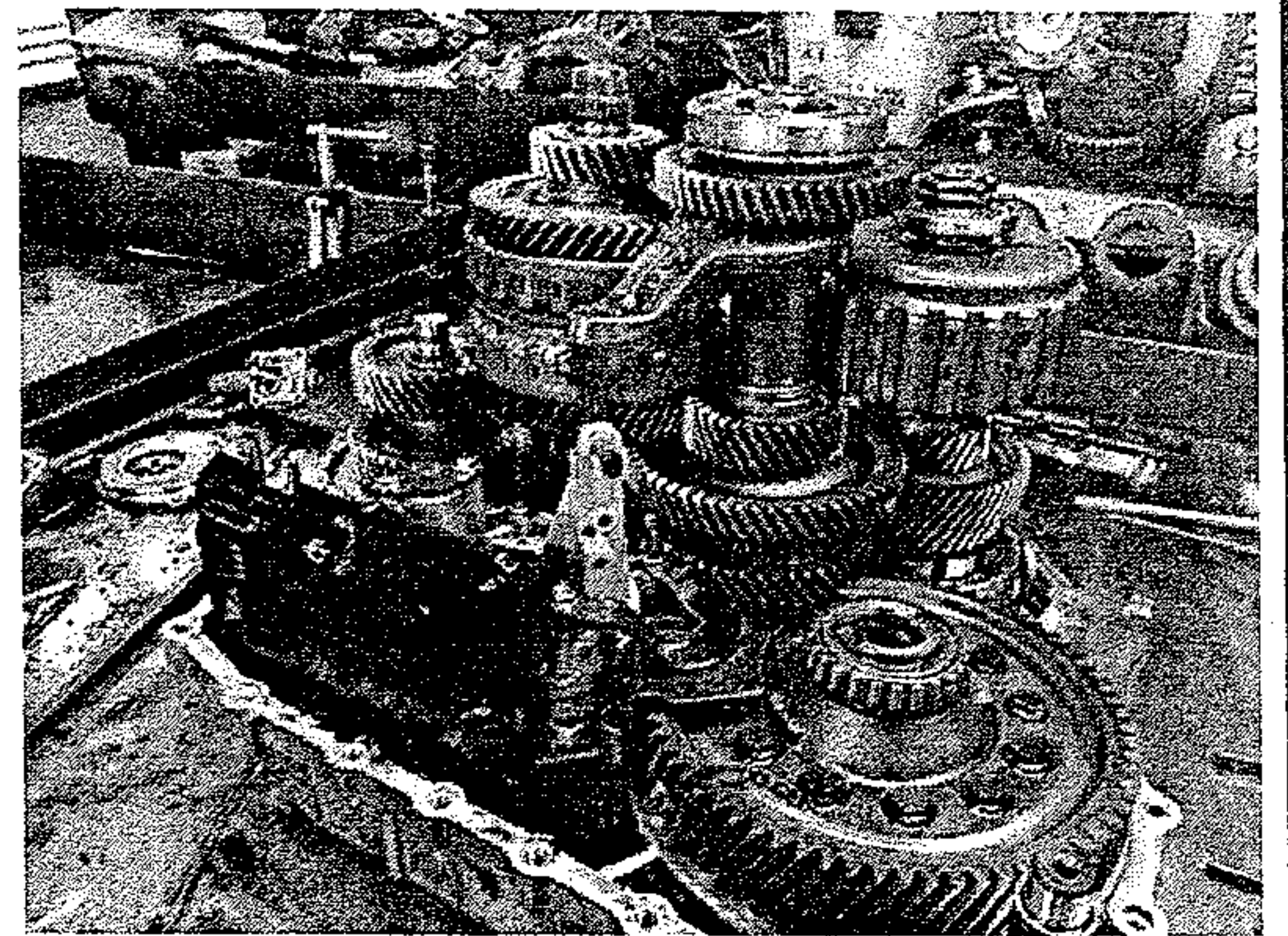

**State-of-the-Art Diagnostics**

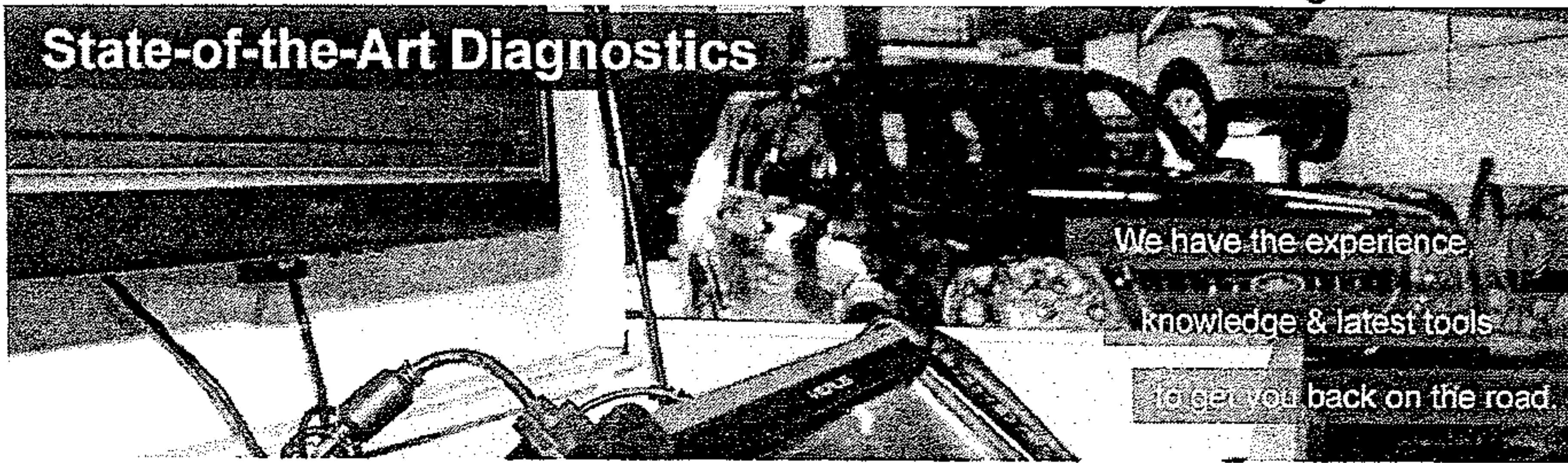

We have the experience

knowledge & latest tools

to get you back on the road.



[budget-transmissions.com](http://budget-transmissions.com)



Approved Auto Repair



stop

James Drake, 46, Riverview Road Lenoir City, was charged with Simple Possession, and Poss. of Drug Para.

Deputy Lance Anderson LCSO, observed a silver Ford Focus traveling 65 mph in a posted 45 mph speed zone. Upon traffic stop Deputy identified the driver as James Drake. The driv-

er had opened the drivers side door and this deputy observed a blue glass pipe with a green leafy substance in the pipe bowl. Deputy asked the driver what was in the pipe and he stated he the substance was marijuana and he used the pipe to smoke it. While frisking the driver for weapons the driver gave this deputy consent to enter his

pockets. In the drivers front left pants pocket Deputy found two small round pills with marking M on one side and T7 on the other. The driver stated the pills were Tramadol, which is a schedule IV. The driver was taken into custody and transported to the Loudon County jail without incident. Deputy Lance Anderson LCSO, made the arrest.

wreck ctd. from pg. 3

with a strong alcoholic odor coming from the vehicle. The driver was not located at the scene. Later Deputy Chris Hutchens received a call from the mother of Thomas and stated that he was the driver of the vehicle. Thomas turned himself in at the Loudon Jail, where Cpl. David Bearden LCSO, served

the Warrant on Him.

FBI ctd.. from pg. 4

police agencies to provide training and discuss crime reporting issues.

In addition to releasing annual Hate Crime Statistics reports, which give the nation a clearer picture of the overall crime problem, the FBI also investigates incidents of hate crimes—as a matter of fact, it's the number one priority within our civil rights program. We investigate hate crimes that fall under federal jurisdiction, assist state and local authorities during their own investigations, and in some cases—with the DOJ's Civil Rights Division—monitor developing situations to determine if federal action is appropriate.

The 2016 release of the Hate Crimes Statistics report, which will contain 2015 data, will feature even more information—expanded bias types in the religion category and the added bias type of anti-Arab under the race/ethnicity/ancestry category. The collection of both types of data began in January 2015.

Loudon County Sheriff's Office Toys for Tots 2015

Thanks to the generosity year after year of the Loudon County residents, churches, businesses and industries, the Loudon County Sheriff's Office is once again able to offer the Toys for Tots program. We are beginning our 31st year of providing toys to the needy children of Loudon County, and thanks to generous contributions of time, money and gifts, we are able to make Christmas a more (see T4T ctd.. pg. 8)

# PURDY'S AUTO PARTS AND SALVAGE

WE BUY SCRAP IRON • COPPER • BRASS • ALUMINUM

**\$** **Paying Top \$\$\$**  
Call For Latest Prices

*You Name It, We Buy It!*

*Radiators, Wheels, Batteries, Appliances, Farm Equipment*

**Copper**  
**Paying Top \$\$\$**  
Call For Latest Prices

**Complete Cars**  
per 100 lbs.

**Scrap Metal**  
**Paying Top \$\$\$**  
Call For Latest Prices  
per 100 lb

**We Buy Batteries**

**Aluminum Cans**  
**Paying Top \$\$\$**  
Call For Latest Prices

**You Call We Haul!**  
**423-519-5402**

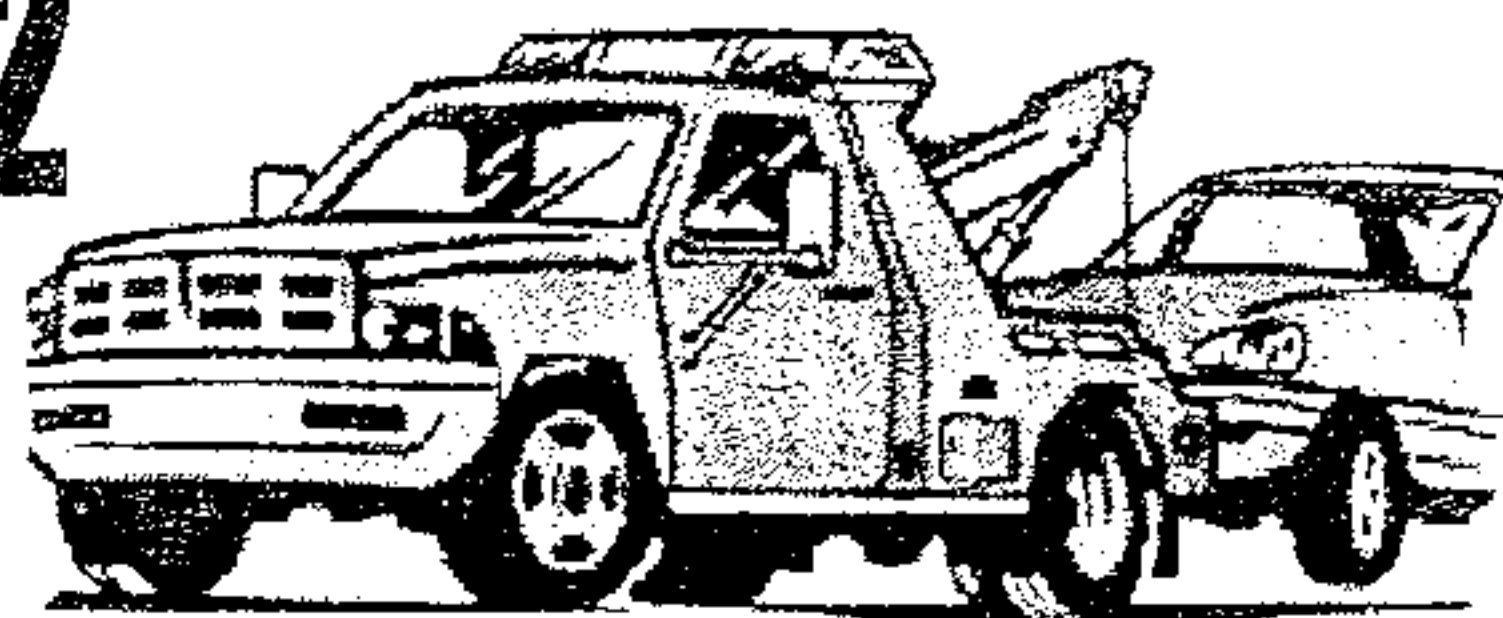

**Now Selling**  
**Aftermarket**  
**Body Parts at**  
**Discount Prices**

Prices subject to change with the market.

**423 337-3977**  
**149 County Road 323 Sweetwater**

Prices subject to change with the market.

**vandalism**

side of the road, and turned into River Oaks. The driver stated he turned in behind the vehicle and witness the driver drive up on the curb. When Officer arrived he did witness the vehicle sitting sideways in both lanes of travel. Of-

ficer identified the driver as Thomas Black, who had trouble standing, bloodshot watery eyes, slurred speech, and a strong odor of an alcoholic beverage coming from his person. Thomas did poorly of sobriety test and was placed under arrest. Officer Brandon Nix LPD, made the arrest.

**OBITUARIES**

**Evelyn Hyatt Luttrell** - age 81 of Lenoir City, passed away suddenly Saturday, November 14, 2015 at her home. She was a member and Sunday School teacher at Oral Baptist Church for many years and retired from Baptist Health Care Center. Evelyn was preceded in death by her husband, John Luttrell; parents, Claude and Bertie Hyatt; brothers, Ronald and Charles Hyatt. She is survived by her sons and daughters-in-law, Mike and Dawn Luttrell of Lenoir City, Eddie and Donna Luttrell of Chillicothe, OH; grandsons: Chuck, Jonathan (Renee), and Logan Luttrell; great-granddaughter, Tiffany Luttrell Chitwood; great-grandson, Balem Logan; sis-

ter, Virginia Clark of Lenoir City along with several nieces and nephews. The family will receive friends from 5-7 p.m. Monday at Click Funeral Home in Lenoir City. Funeral services will follow at 7 p.m. with Rev. Jack Belcher officiating. Family and friends will gather at the funeral home by 10:30 Tuesday morning at proceed to Loudon County Memorial Gardens for 11 a.m. graveside services.

**Harley McCrary**, 72, of Loudon, passed away Monday, November 16, 2015. He was a member of Corinth Baptist Church and retired employee of Caterpillar Co., Peoria, IL. Preceded in death by first wife, Ruth McFalls McCrary; parents, Ralph and Bessie Brown McCrary. He is survived by wife, Barbara Casteel McCrary; daughter, Sonja McCrary, both of Loudon; step children, Heather and Joey Exum, Kevin Casteel and Nikki, all of Lenoir City; two grandchildren, Emma and Xander Casteel; brother, Rick and Sherri McCrary of Madisonville; special niece and nephew, Hannah (Dallas) Schean and Micah Mc-

Crary. Funeral service Thursday, 7:00 pm, Loudon Funeral Home Chapel, with Rev. Mike Arp officiating. Graveside service Friday, 11:00 am, Loudon County Memorial Gardens. Family will receive friends 5:00-7:00 pm, Thursday. In lieu of flowers, the family requests donations be made in Harley's memory to the American Diabetes Association, Knoxville TN Office, 211 Center Park Dr., Suite 3010, Knoxville, TN 37922 or Corinth Baptist Church Cemetery Fund, 6100 Corinth Church Rd. Loudon, TN 37774. Arrangements provided by Loudon Funeral Home.

**For Sale: oak Wood Mulch**



**Mushroom Compost Topsoil.**



**Firewood**

**Call Steve Spoon 986-4282**

**Is Your Washer Broken?**

**Call Me**

**I Only Charge \$100 Period!!!**

**Call Allen**

**865-617-7113**

**LOOK! \$75 Weekly Payments LOOK!**

MARTY'S AUTO SALES • 986-2222 • MARTY'S AUTO SALES • 986-2222 • MARTY'S AUTO SALES • 986-2222 • MARTY'S AUTO SALES • 986-2222 • MARTY'S AUTO SALES • 986-2222 • MARTY'S AUTO SALES • 986-2222

**Bad Credit**  
**Divorce**  
**Fixed Income**  
**Repos**  
**Bankruptcy**  
**No Credit**

**APPROVED!**

**NO CREDIT CHECKS**

**Visit Us On The Web At: [martyautosales.net](http://martyautosales.net)**



**\$499 down\***

**07 Cobalt, 5spd, gas saver, runs great Only \$499 down\***



**\$499 down\***

**02 Sable, sunroof, loaded, Only \$499 down\***

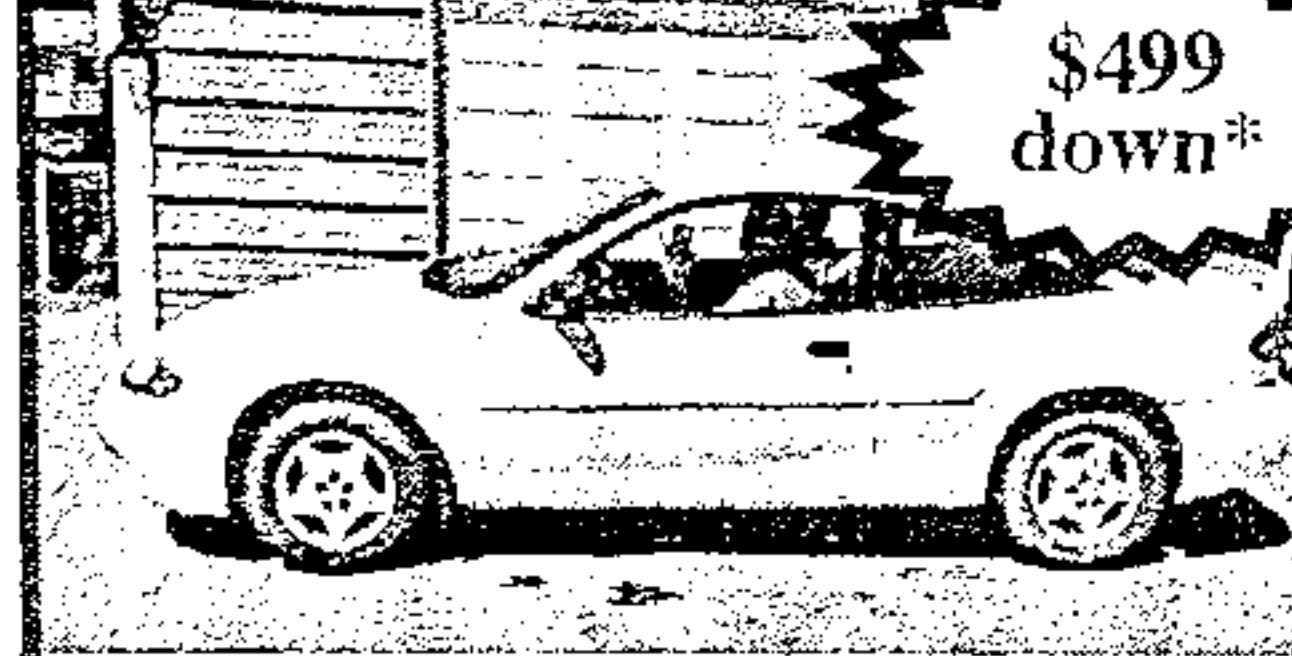

**\$499 down\***

**04 Cavalier, 2dr, Sporty, Only \$499 down\***



**\$499 down\***

**01 Sebring 2dr. sporty, Only \$499 down\***

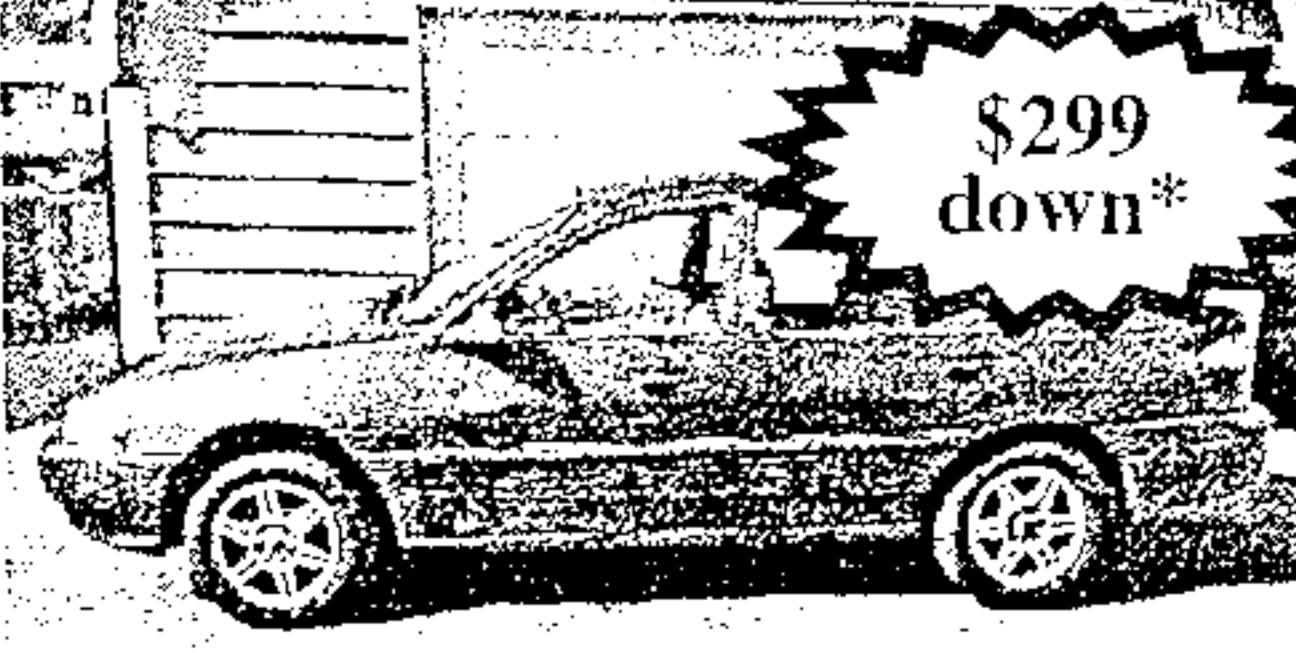

**\$299 down\***

**97 Escort, auto, Gas Saver, Only \$299 down\***



**\$499 down\***

**03 Focus 5 speed, Gas Saver Only \$499 down\***



**\$399 down\***

**01 Venture, 7 passenger, Runs Great Only \$399 down\***



**\$499 down\***

**00 Ram, High Top Conversion Van, Loaded only \$499 down\***

**NO Credit Checks**

**Marty's Auto Sales 986-2222**

**100% Approval\***

\*See Dealer for details. All down payments plus tax, tag, title and fees.

MARTY'S AUTO SALES • 986-2222 • MARTY'S AUTO SALES • 986-2222 • MARTY'S AUTO SALES • 986-2222 • MARTY'S AUTO SALES • 986-2222 • MARTY'S AUTO SALES • 986-2222 • MARTY'S AUTO SALES • 986-2222

T4T ctd. from pg. 5

joyful time for more and more children. In 2014, approximately 500 children were helped by the Loudon County Sheriff's Department Toys for Tots program through their partners. Even with the difficult economic times we are experiencing, we hope that the people of Loudon County will be there once again to help.

If your business or church would be willing to take names please call

Debbie Hines, Toys for Tots Coordinator at 986-4823.

Names are available through business and churches. If you are considering helping a child this Christmas, please be assured that applicants are thoroughly checked to make sure they require this assistance. Names are also compared with the school systems to make sure no one is receiving duplicate assistance.

**A Name You Already Know And Trust Just Got Even More Dependable**  
**DEPENDABLE AUTO SERVICE, LUBE AND TIRES**  
**is Now Offering**  
**Expert, Affordable Transmission Service**

All ASE Certified Technicians

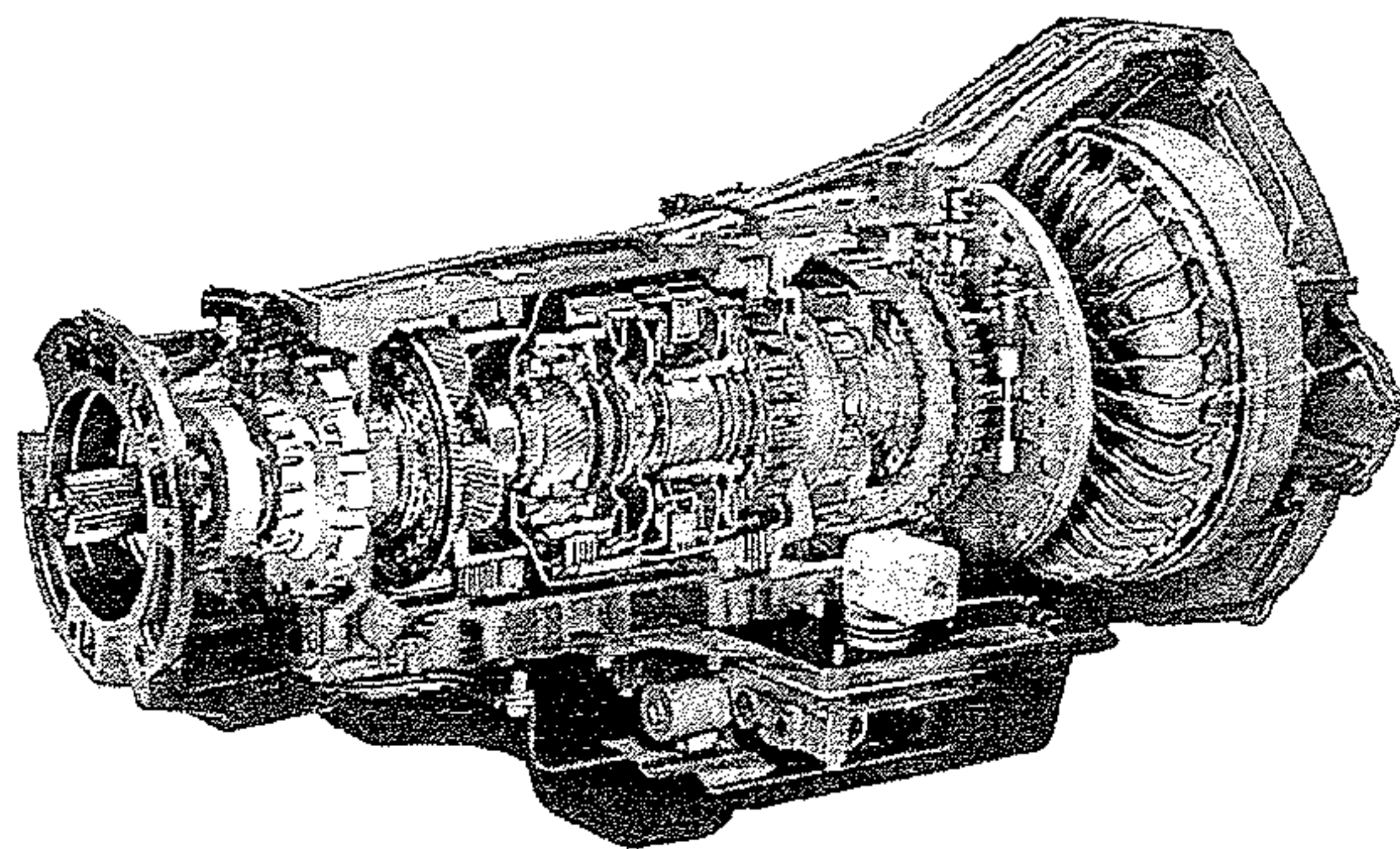

**We proudly welcome all New Customers and Former Advanced Transmission Customers with a 10% Discount and Any Transmission Service or Repair\***

**865-986-9359**

**865-986-5050**

**LONNIE JONES OPTICAL DISPENSARY**

"We Make The Difference You Can See"  
 Locally Owned and Operated

Over 1000 Frames To Choose From  
 No Frame Over \$69.00



On the corner of A & Depot Street, Lenoir City

**986-7803**

Serving Loudon County for over 40 years

**Bad Credit, No Credit OK!!! We Finance Everybody!!!**

**Low Down Payment!!!**

**Over 100 Cars, Trucks & Vans in Stock - Warranties On ALL Vehicles Sold!!!**

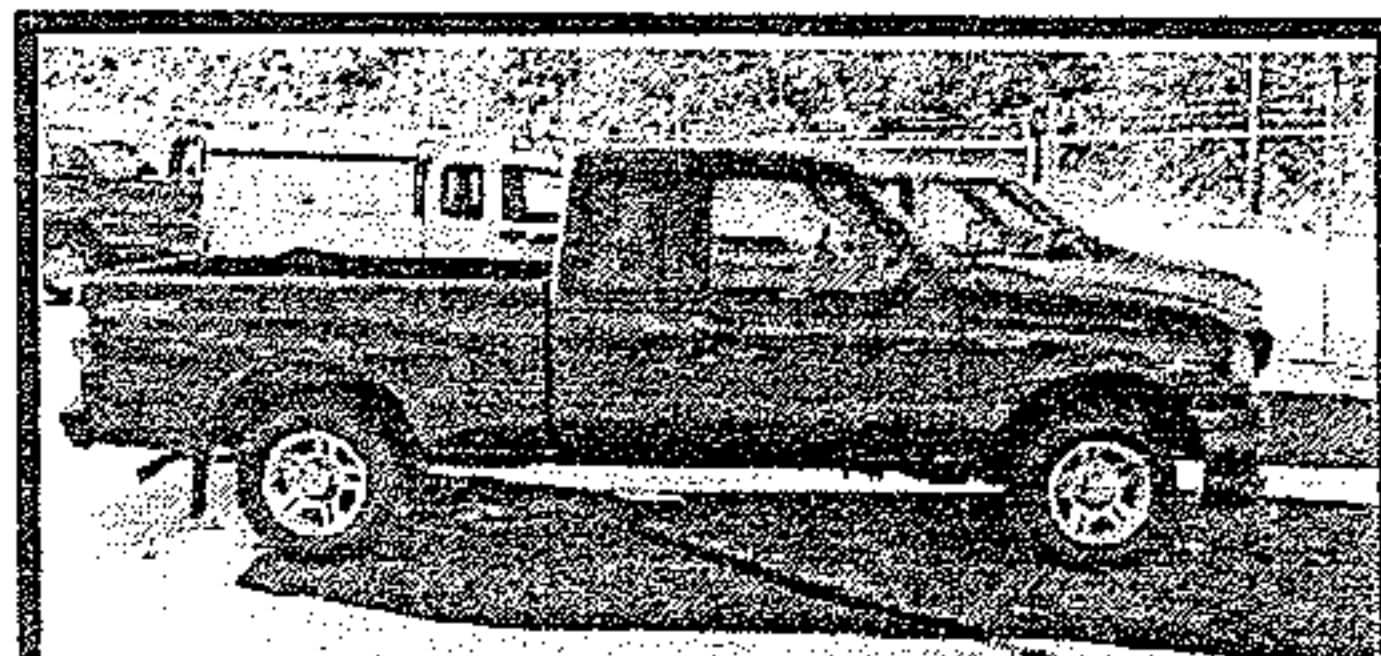

**2005 Ford Ranger, Super Nice Truck, Very Low Miles**

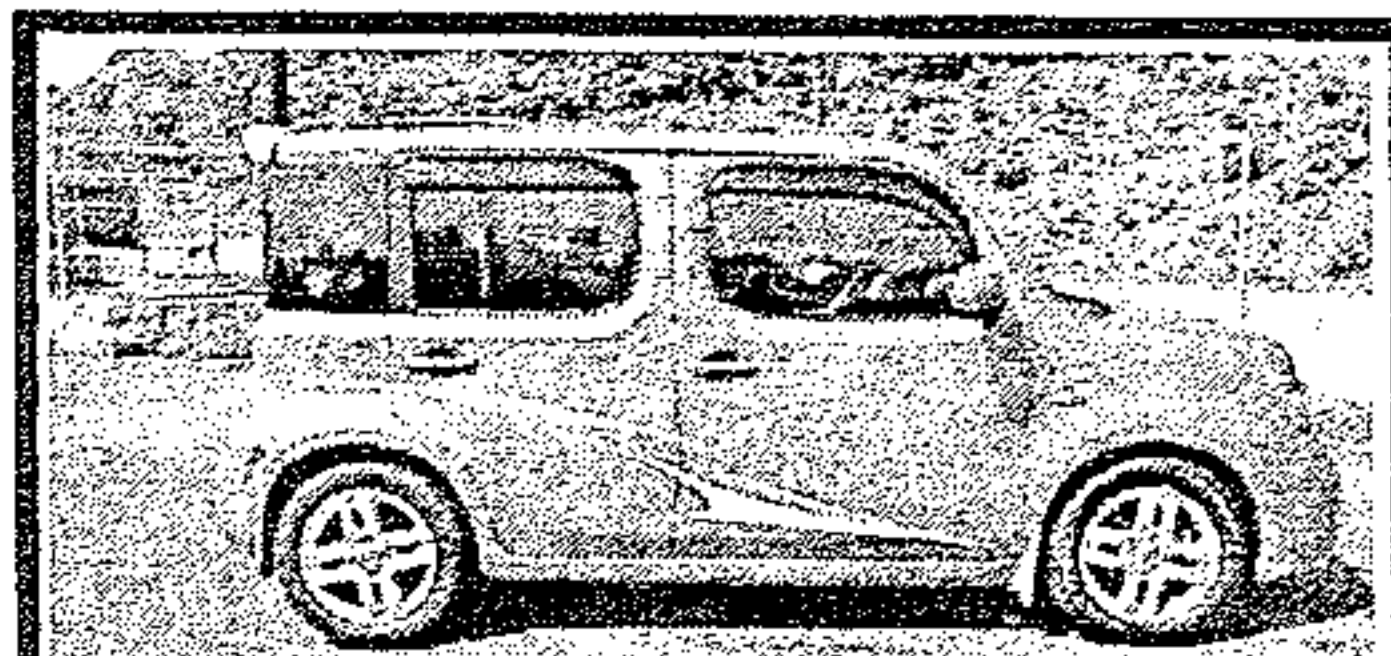

**2009 Nissan Cube, Great Gas Saver, Clean**

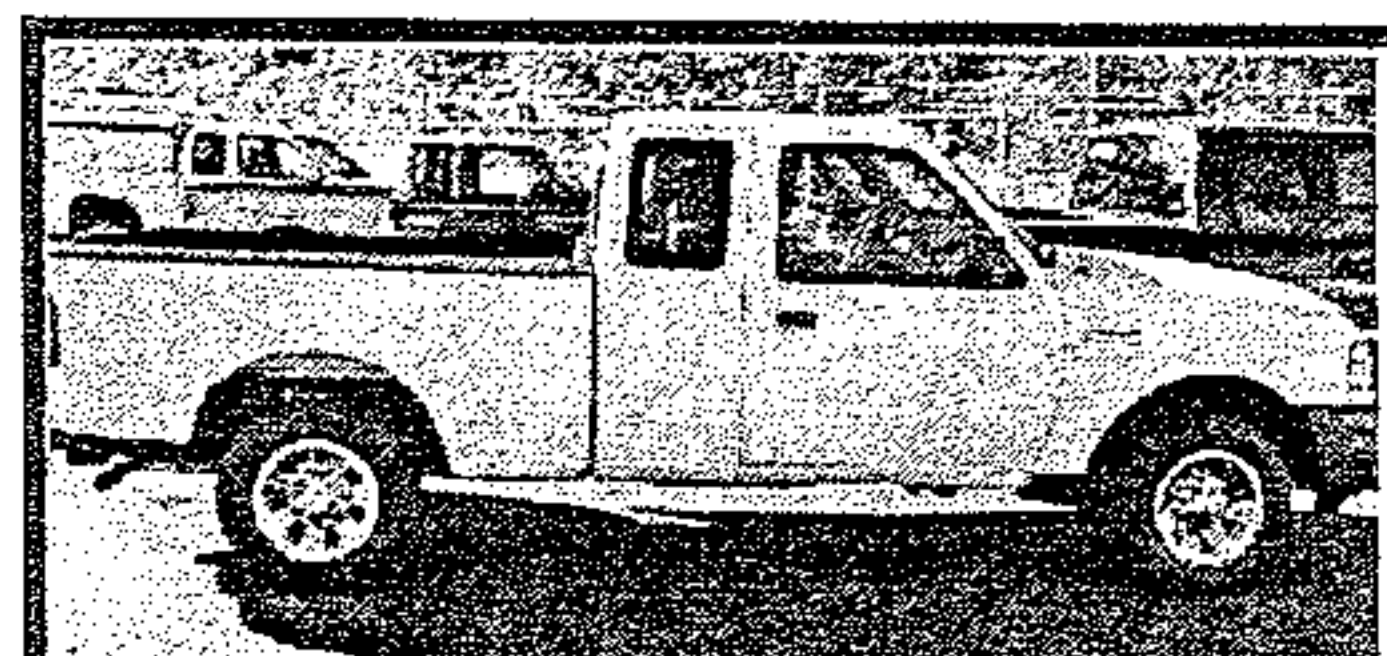

**2010 Ford Ranger, nice truck, low miles, extended cab**

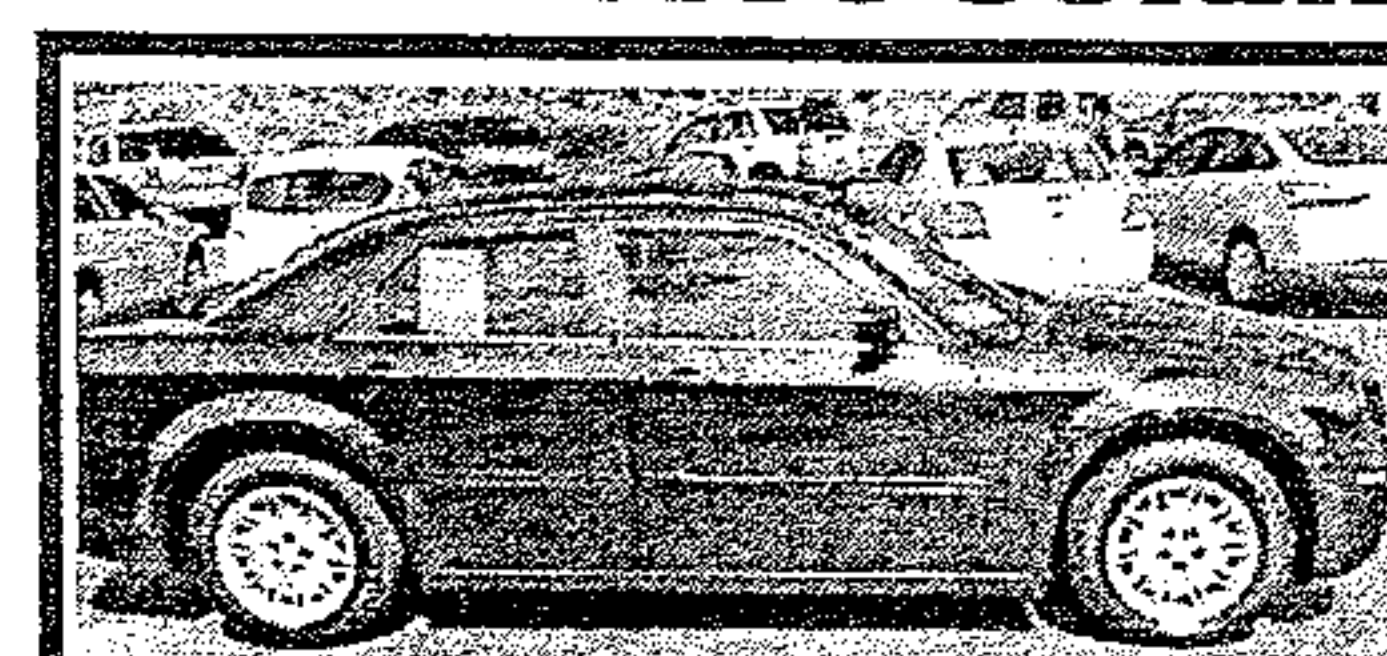

**2006 Chrysler 300, Loaded, Nice Ride**

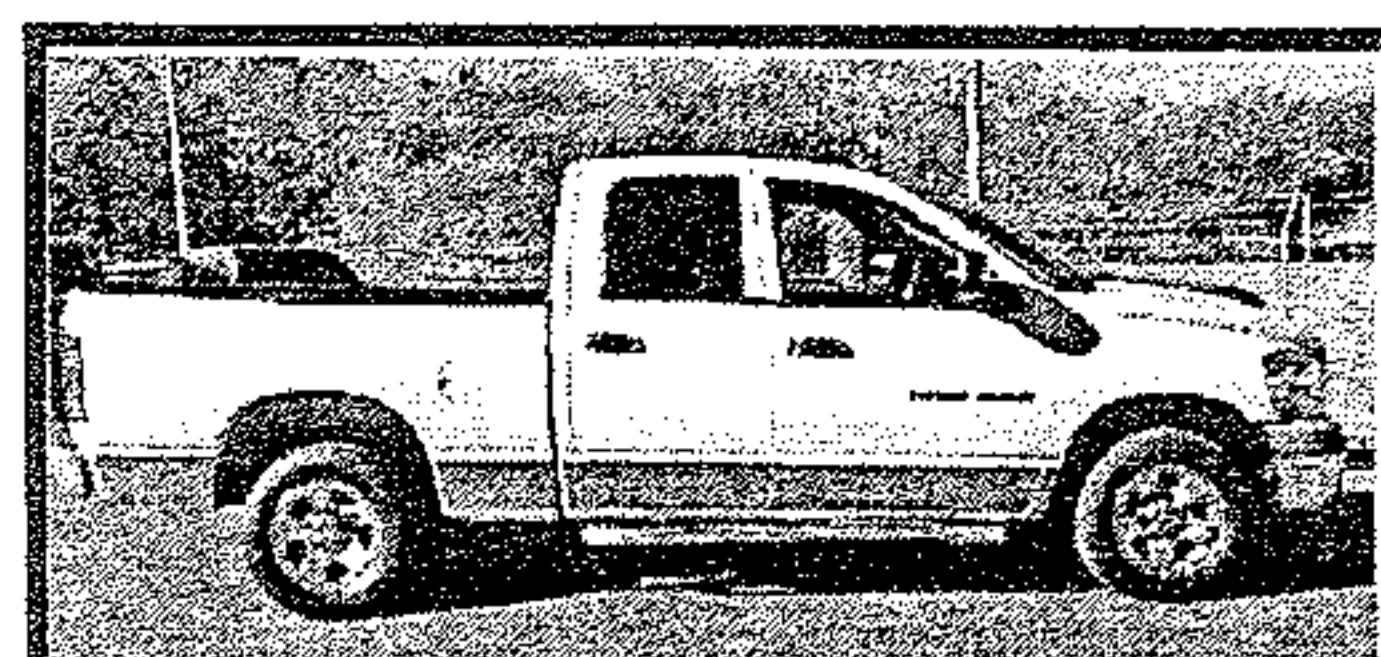

**2010 Dodge Ram, 4dr, Great Work Truck, lots of room**

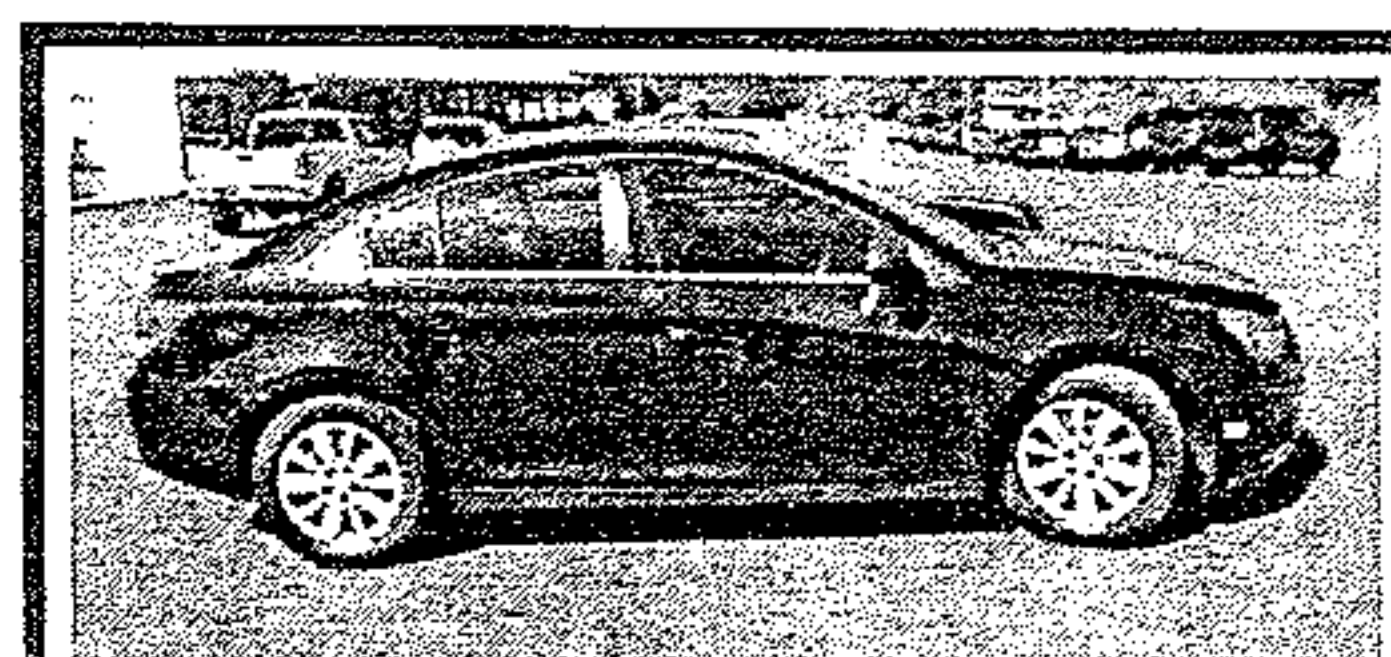

**2011 Chevrolet Cruze, LOADED!!!**



**2007 Suzuki Grand Vitara, V6, Nice!**

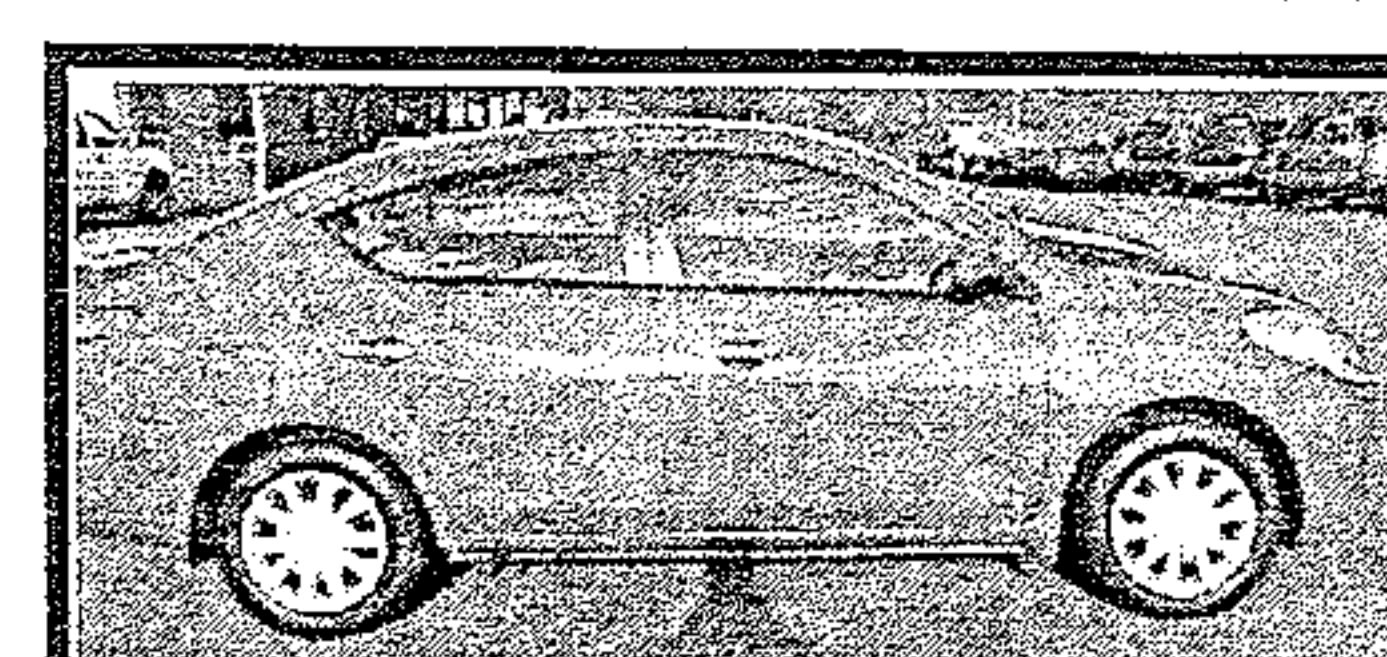

**2013 Nissan Versa, Like New!, LOADED!!!**

**WALT WILLIAMS, INC.**

\*with approved credit

3003 Highway 11

Lenoir City, TN

**865-986-1111**