

The Daily Edition

Why Did The Chicken Cross The Road?
find out page 7 **50¢**

Serving Loudon, Monroe and Surrounding Counties

Monday 16
Friday, November 13, 2015

Friday bank robbery in Pigeon Forge

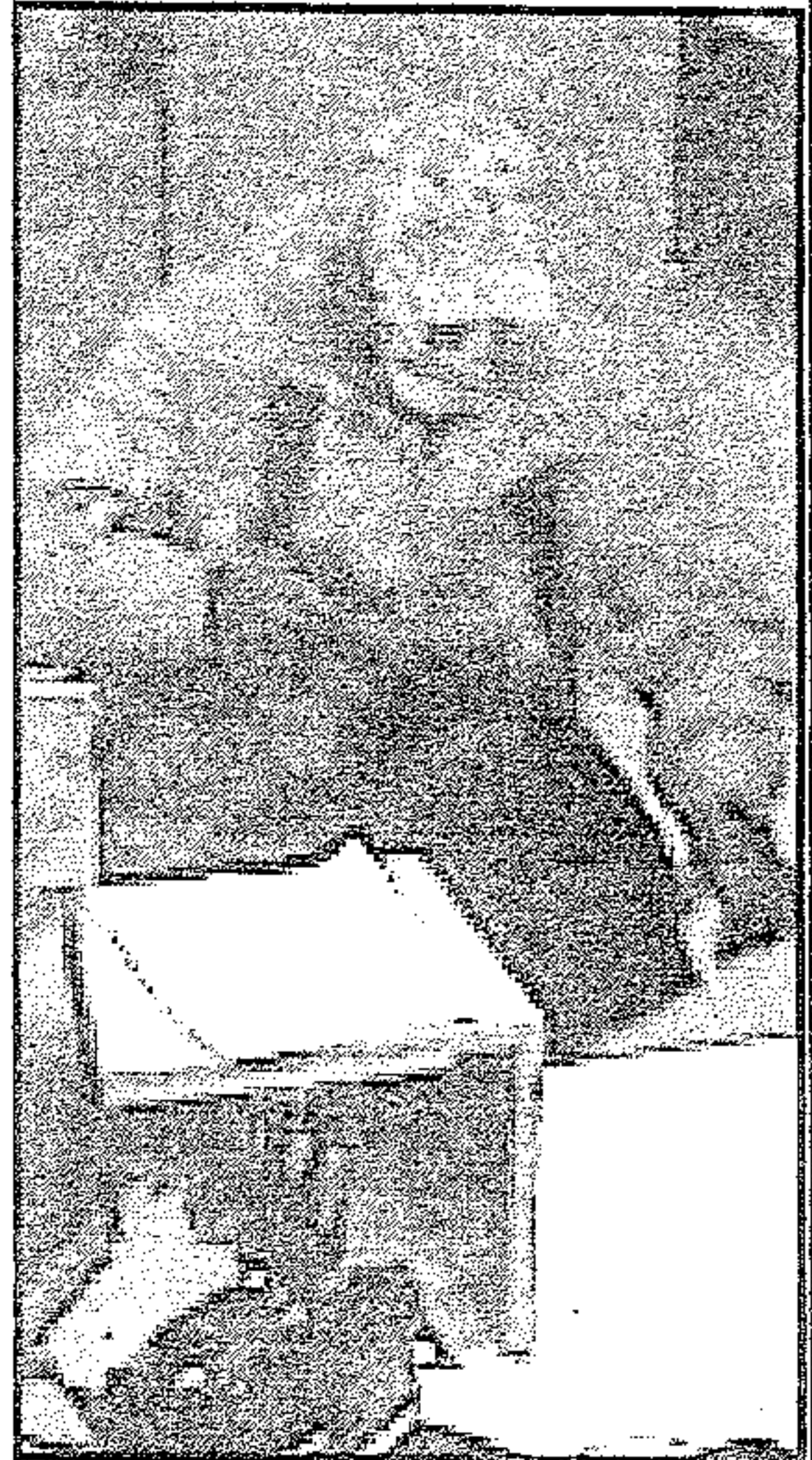

(see robbery pg. 3)

Harassment draws gun; gun nets charges

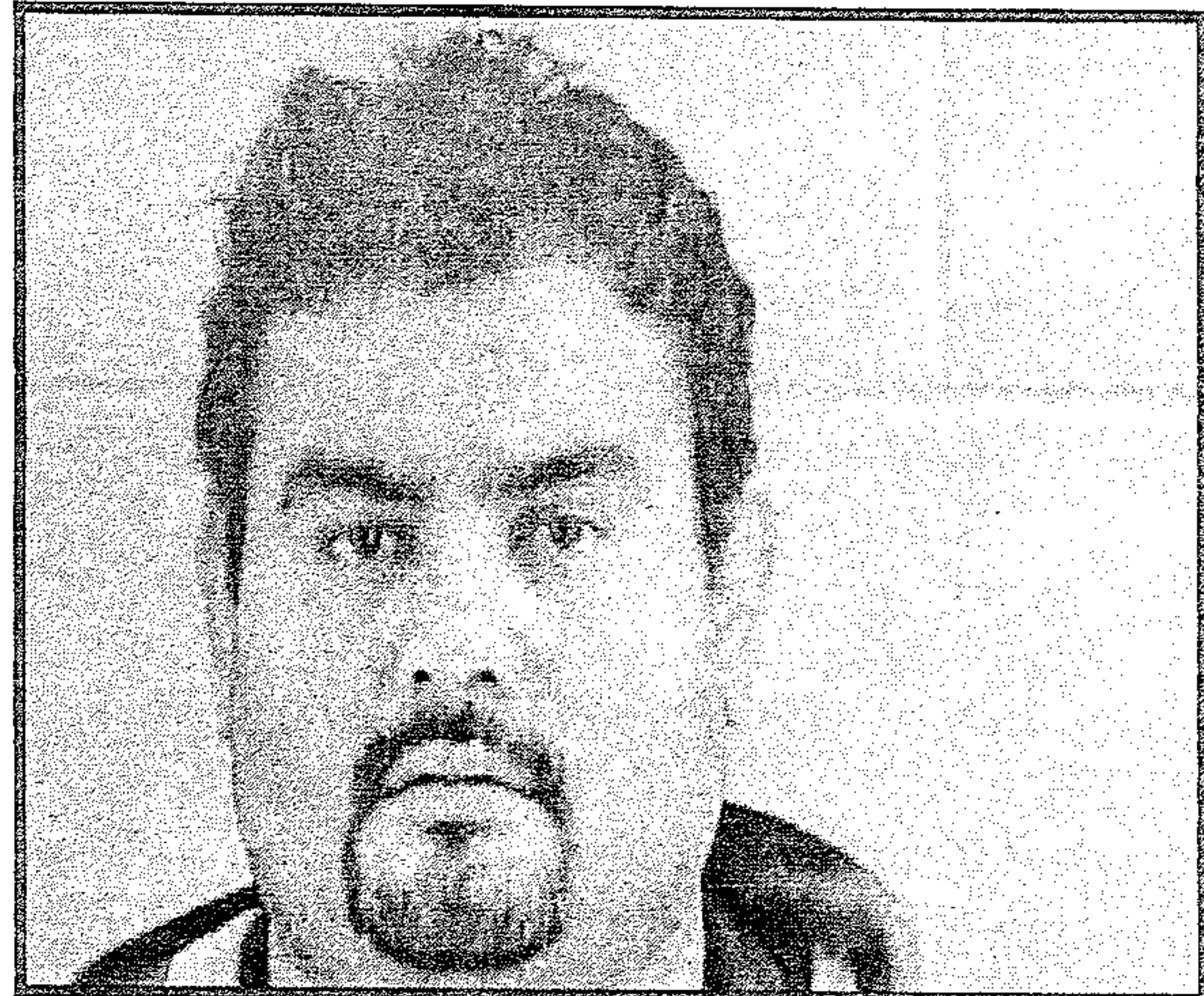

Julio Rojas

(see gun pg. 2)

Man pins down victim then found lying in woods to avoid conflict

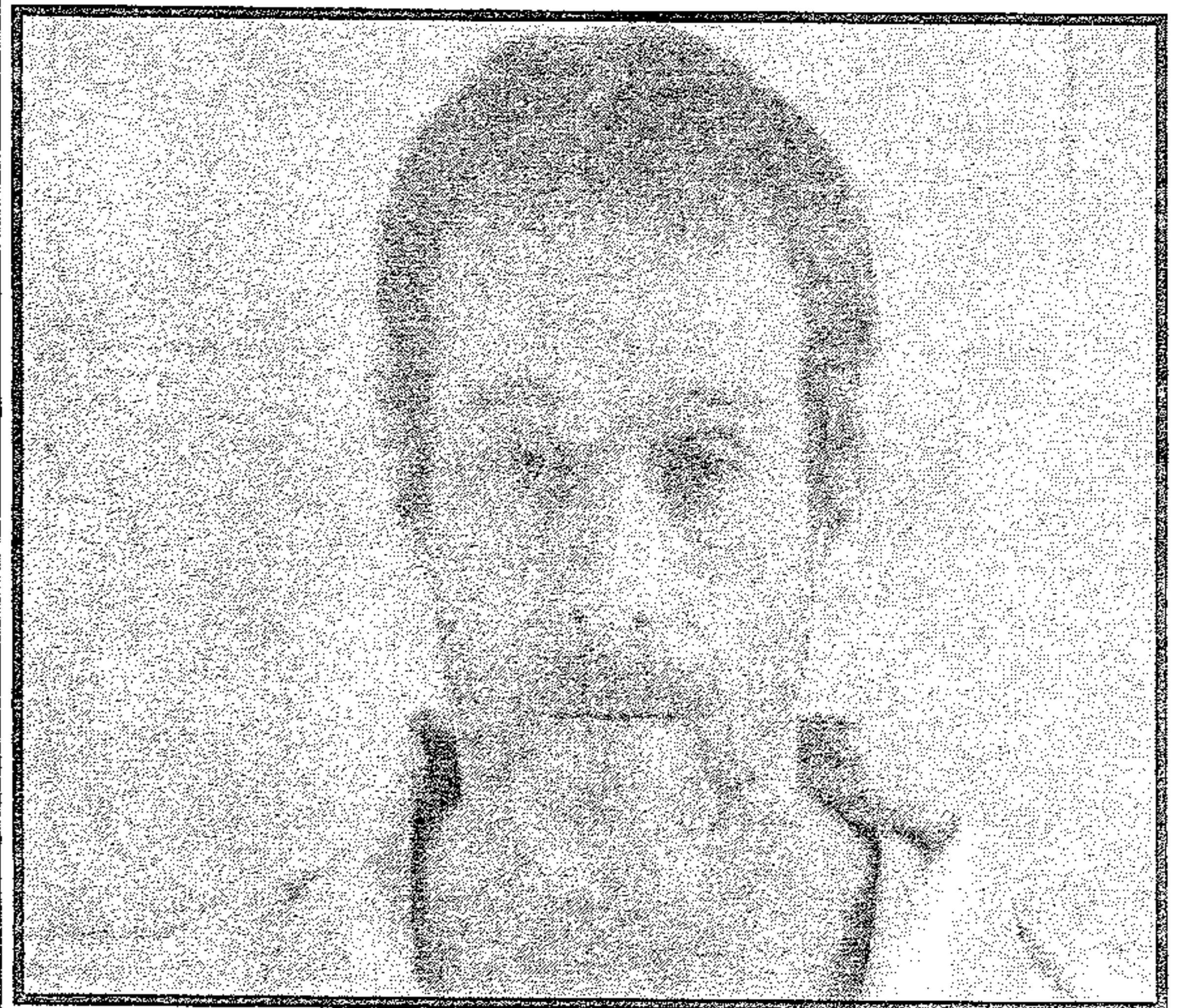

Joseph Landreth

(see DV pg. 5)

Pool fight ends with charges for Loudon woman

Ashley Claxton, 24, Hwy 72 South Loudon, was charged with Domestic Assault.

Officer Bobby Lankford LPD, received call of a white female and a black male fighting at the loudon swimming pool parking lot at 1051 mulberry st in loudon. Upon arrival this officer identified subjects known by this officer as the victim

(see fight pg. 7)



Ashley Claxton

Newseum Goes "Inside Today's FBI"

D.C. Museum Updates Popular Exhibit

Some of the FBI's biggest terrorism cases since 9/11—along with headline-grabbing espionage and cyber investigations—are featured in an exhibit that opens today in the nation's capital.

"Inside Today's FBI: Fighting Crime in the Age of Terror" is an updated and expanded version of a popular, long-running exhibit at the Newseum, a mu-

seum devoted to news and journalism located a few blocks from FBI Headquarters in Washington, D.C.

A collaboration between the Bureau and the museum, "Inside Today's FBI" will display evidence and artifacts never before seen by the public, including the blue Toyota Corolla abandoned by terrorist hijackers prior to the 9/11 attacks and the

(see FBI pg. 4)

Verse of the Day

We ought always to thank God for you, brothers, and rightly so, because your faith is growing more and more, and the love every one of you has for each other is increasing. — 2 Thessalonians 1:3

Obituaries

see inside **Wazzup**

A BIG Shout Out To First Baptist Church Lenoir City, Thanks You So Much for a great concert and especially for holding onto Mom's Scooter!

Weather

Today: Intervals of clouds and sunshine. High 63F. Winds light and variable. Tonight: Mostly cloudy skies. Low 48F. Tuesday Cloudy skies early, followed by partial clearing. High around 70F.

Tuesday Night Mainly cloudy. Low 57F.

Horoscopes

Scorpio 10/23-11/21

You have an unexpected chance today to see things that are usually buried far out of sight

(Continued on page 6)

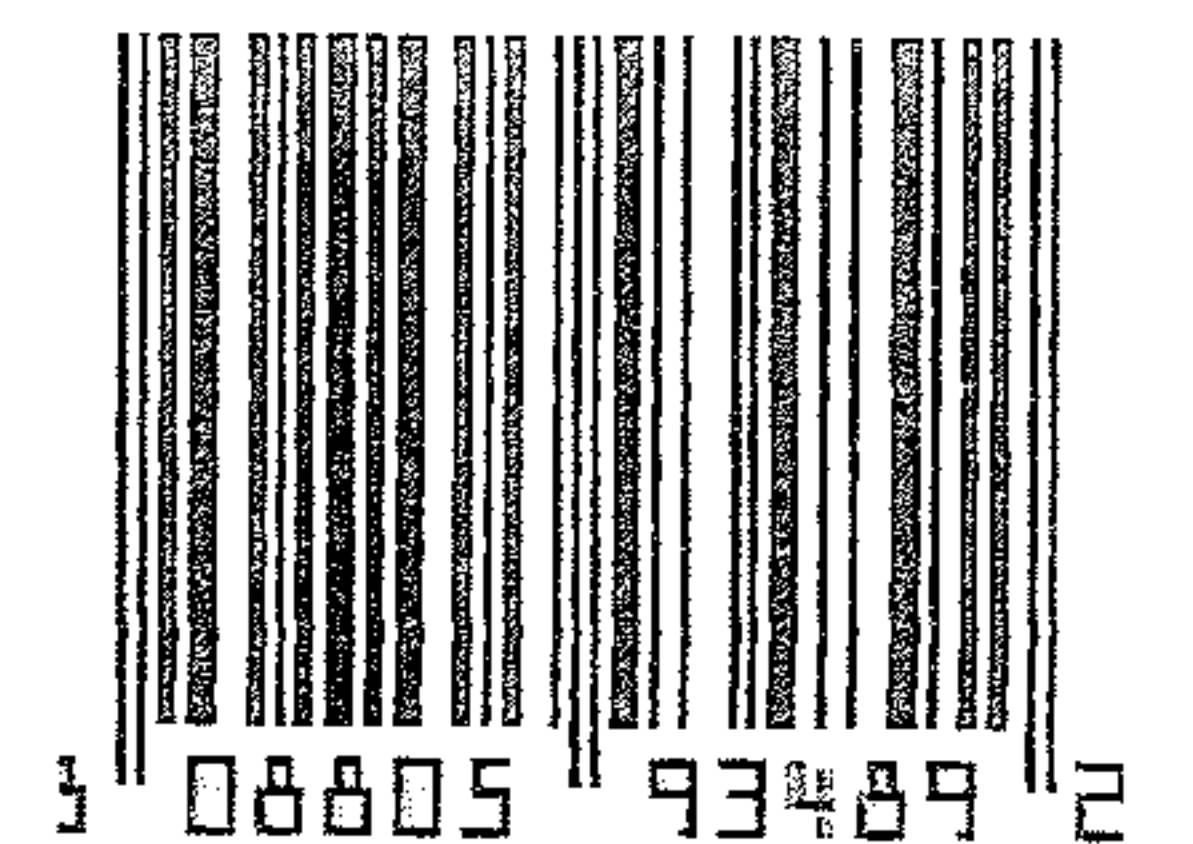

gun

Julio Rojas, 32, Spring Street Philadelphia, was charged with Reckless Endangerment.

Corporal Rondel M. Branam, was dispatched to Spring Street in reference to a possible shooting. Upon speaking with the complainant, he stated he was picked

up by friends in Loudon and was taken to Spring Street in Philadelphia, TN because some of their friends had been beaten up earlier in the day. When he arrived victim stated that he was attacked by two hispanic males, and one of the males fired a hand gun at him three times. The shooter told victim that he was going to kill him. Vic-

tim stated that he then ran to Spring Street to get a phone to call 911. Deputy did make contact with Julio Rojas at Spring Street and asked him what had happened earlier.

Julio told the officer the
(see gun ctd. pg. 3)

Notice
Vin 1G82557N87F202859
General Motors Vehicle will be sold. If anyone has a lien on this vehicle contact: Homer's Body Shop, 10609 Beals Chapel Road, Lenoir City, 37772, 865-388-0372.

Notice: The Daily Edition does not knowingly accept fraudulent or misleading materials. The Daily Edition cannot guarantee the validity of offerings or statements contained herein. All liability for the contents of all advertising, and for any claims that may arise therefrom, is the responsibility of the advertiser or its agency. The Daily Edition reserves the right to reject, edit, or abbreviate any advertisement submitted. Advertising is accepted with the understanding that all liability for all copyright violations is the sole responsibility of the advertiser. Photographs, artwork and other copy submitted for publication is considered the sole property of the advertiser. The Daily Edition will make every effort but will not be liable for failure to publish and ad or for typographical and layout errors. All statements and information about highlights featured items, letters to the editor, herein are those solely given to the interviewer or writer and the Daily Edition assumes no responsibility of the accuracy or validity thereof. The Daily Edition will gladly reprint at no charge that part of an advertisement in which an error occurs provided a claim is made within 3 days of the first publication of the ad. Information contained in the Wazzup is received anonymously and the Daily Edition assumes no responsibility for information and reserves the right to edit or reject any and/or all submissions. The Daily Edition is a daily newspaper of general circulation in Loudon County defined under TCA 2-1-104(a)(13). The Daily Edition also serves Monroe, Knox, Anderson, Roane and Blount counties and serves 30,000 readers weekly. Send mail to PO Box 1240, Lenoir City TN 37771. 865-771-2249. email: dan1204us@yahoo.com
The Daily Edition is Loudon County's premier public interest and paid advertising paper. The Daily Edition is produced and published daily Monday through Friday and is circulated throughout Loudon County and parts of Monroe and Knox Counties. Display advertising rates \$5.00 per column inch and quantity discounts available. Call for information on upcoming promotions and events.

HACIENDA Ayala's
Mexican Restaurant
Market Dr. * Lenoir City (In Front of Food City)

Real Authentic Mexican Food at Affordable Prices

BEST MARGARITA

You've Tried The Rest Now Come Have The Best!!!

We Accept ALL Competitors Coupons Outside of Mexico City!

986-3553

Good Credit OK • Bad Credit OK • Bankruptcies OK • Repo OK



2010 Kia Soul Sporty, 4 cyl, Auto, PW, PL, A/C, Great On Gas, Like New



2010 Ford Escape Limited Leather, Alloy Wheels, Heat, A/C, Luggage Rack, 79K,



2007 Dodge Ram 1500 Quad Cab, Thunder Road PKG, 20 in. Wheels, Low Miles, Hemi



2008 Ford Explorer 84k, 3rd Row Seating, Luggage Rack, Tow Pkg, PW, PL



2011 Ford Ranger Low Miles, Tow Pkg, New Tires, A/C, Heat, Bed Liner.



2011 Dodge Grand Caravan DVD, Stow & Go, Loaded, Remote Doors, Rear A/C

DEPENDABLE MOTORS 986-9343
803 E. Broadway • Lenoir City

Serving Loudon County for 20 Years

* WAC. See Dealer for details

Visit our website at: www.dependablemotorslc.com

robbery

At approximately 5:58 p.m. today, the Home Federal Bank, at 3671 Parkway, in Pigeon Forge was robbed. One white male subject, approximately 6'02" to 6'04", 225-250 pounds, wearing a full face mask, gloves and armed with a semi-automatic handgun got away with an undisclosed amount of money. The case is being investigated by the Pigeon Forge Police Dept. and the FBI Safe Streets Task Force, composed of the FBI, Knoxville PD, and the Knox County Sheriff's Office. Anyone with information about this robbery should call the FBI at 865-544-0751.

Gun ctd. from pg. 2

victim and some of his friends were harassing his wife. Julio then stated he got his hand gun and shot at victim three times. Julio told Deputy that he could take the gun and told Deputy where to retrieve it. Deputy did retrieve the gun and contacted Investigator Jeff Russell about the incidents. Investigator Russell did respond to the scene and spoke briefly to

all parties involved and did take the hand guns in to his possession. Deputy was then advised by Investigator Russell to take Julio in to custody and transport him to the Loudon County Jail. Deputy did transport Julio to the Jail and placed him on an investigational hold for Investigator Russell.

Police beat

Ismael Granados, 33, Corinth Road Loudon, was charged with Driving on Revoked License. Deputy Tony Branson LCSO, arrested Is-

The Daily Edition
serving Loudon and surrounding counties since 1986

For Sale: oak Wood Mulch



Mushroom Compost Topsoil.



Firewood

Call Steve Spoon
986-4282

mael at Hwy 444 for DORL.

Gwendlyn Heiple, 57, Kingston Hwy Loudon, was charged with Driving on Revoked License. Deputy Jimmy Yoakum LCSO, arrested Gwendlyn at Hwy 70 for DORL.

Dwayne Hubbard, 40, West 5th Ave Lenoir City, was charged with Violation of Probation. Officer

Tyrel Lorenz LCPD, arrested Dwayne at old Hwy 95 on a VOP Warrant, and transported to Loudon Jail.

Dustin Roninson, 23, County Road Sweetwater, was charged with Violation of Probation and Criminal Court Capias. Deputy Eric Curtis LCSO, served Dustin with a CC Capias and a VOP Warrant at the Loudon Co. Jail.

West End Storage & Warehouses
502 Ward Avenue • Loudon
Call 865-458-4774 or 865-679-5555

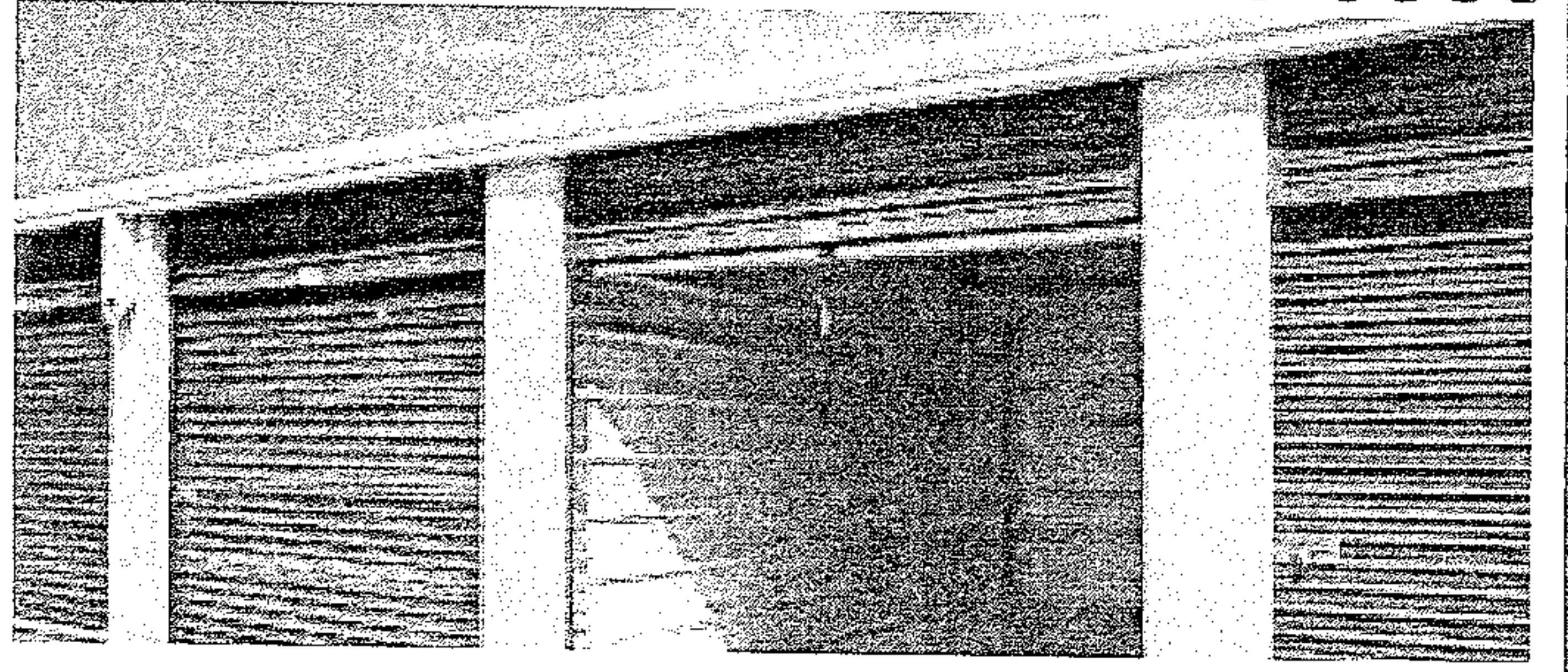

C&J Towing and Recovery
LOWEST TOWING RATES AROUND!!!

Have you been overcharged for any type of towing service in the Lenoir City area? If you have a breakdown or accident please OWNER REQUEST C&J Towing with the officer. Also please call your Sheriff and ask him to place C&J Towing on the "Rotation List*" and help other motorists save as much as you did! We at C&J are locally owned and operated, State approved, licensed, bonded and insured. Call and let us know if your denied service or how we can be of assistance.

*note: the "Rotation List" is a list of wrecker services that provide service for wrecks, DUI's, breakdowns, etc. and are on an on-call basis for service. This list is approved by the Sheriff.

Cliff Teeters • Owner
865-809-1661

BIMBO'S
Deli Open 24 Hours
865-986-9643 Call Ins Welcome
Specials
Lg. Cold Sub, bag of chips and 16 oz. fountain drink
only \$6.29
Footlong Corn Dog \$2.59

FBI

explosives-laden Nissan Pathfinder used in a failed attempt to bomb New York City's Times Square in 2010. Parts of the homemade bomb—propane tanks, alarm clocks, and a pressure cooker—can be seen inside the vehicle. Also on display will be items from the 2013 Boston Marathon bombing, including the handcuffs that restrained bomber Dzhokhar Tsarnaev.

More than 45 new artifacts have been added to the exhibit, which focuses on terrorism as well as recent espionage cases—such as the Russian spy investigation known as Operation Ghost Stories—and cyber cases, like Silk Road, in which the FBI dismantled a secret website that allowed individuals to buy and

sell illegal drugs anonymously online.

“The FBI has had a long and successful partnership with the Newseum,” said Mike Kortan, FBI assistant director of public affairs. “We are pleased that the expanded exhibit provides even more opportunity for people to learn about the FBI and our mission to protect the country.”

The Newseum's original Bureau-related exhibit, “G-Men and Journalists: Top News Stories of the FBI's First Century,” debuted in 2008 and was updated in 2011. In July 2015, the exhibit closed for renovations and opens today in a larger space with more than 160 artifacts, most of which are on loan from the FBI.

The “G-Men and Journalists” exhibit was intended to be temporary but was so popular its run was extended indefinitely. Millions of people have seen it. Other items still on display from the original exhibit include the Unabomber's cabin; engine parts and landing gear from United Air-

lines Flight 175, which crashed into the World Trade Center South Tower on 9/11; and the hiking boots worn by “shoe bomber” Richard Reid, who received al Qaeda training to blow up an American Airlines flight from Paris to Miami in December 2001. The belts passengers (see FBI ctd. pg. 5)

SARCO Enterprises Inc. Offers Complete Home and Commercial Remolding and Repairs

Our Team members have a combined total of over 40 years experience in all areas of home construction, facilities maintenance and commercial construction. Roofing, Electrical, Bath and Kitchen Renovations, we do it all with just one call. We are fully insured and our work is guaranteed.

Call us today for a free no obligation quote for your next project.
865-809-9492.

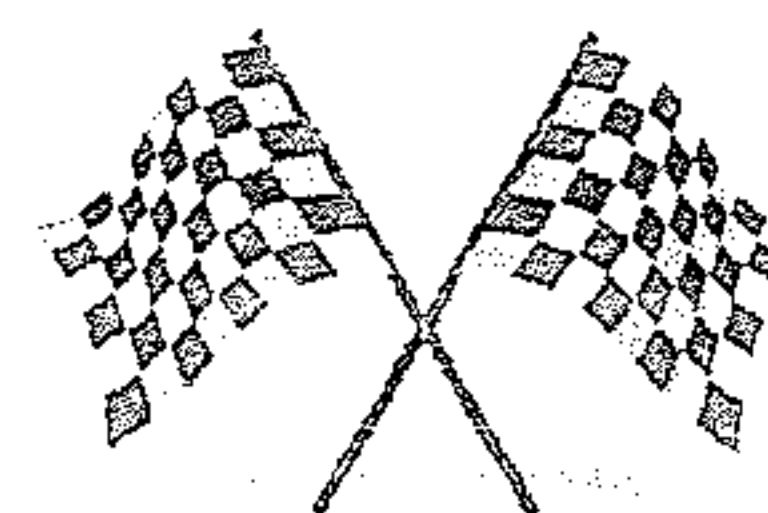

SOUTHERN AUTO DETAILING

414 WEST BROADWAY

LENOIR CITY, TN 37771

865-986-0724

Starting at \$34.95
Present this ad for \$5.00 off

BUDGET
Transmissions

Why Buy From Budget?

Free Towing From Lenoir City
or Loudon County
20 Years of BBB Zero Customer Complaints Award Member
A+ Plus Rated
Huge Transmission Inventory
Best Technicians Period!!!

Call (865) 584-4391 Today!

302 S. Northshore Drive Knoxville

(865) 584-4391

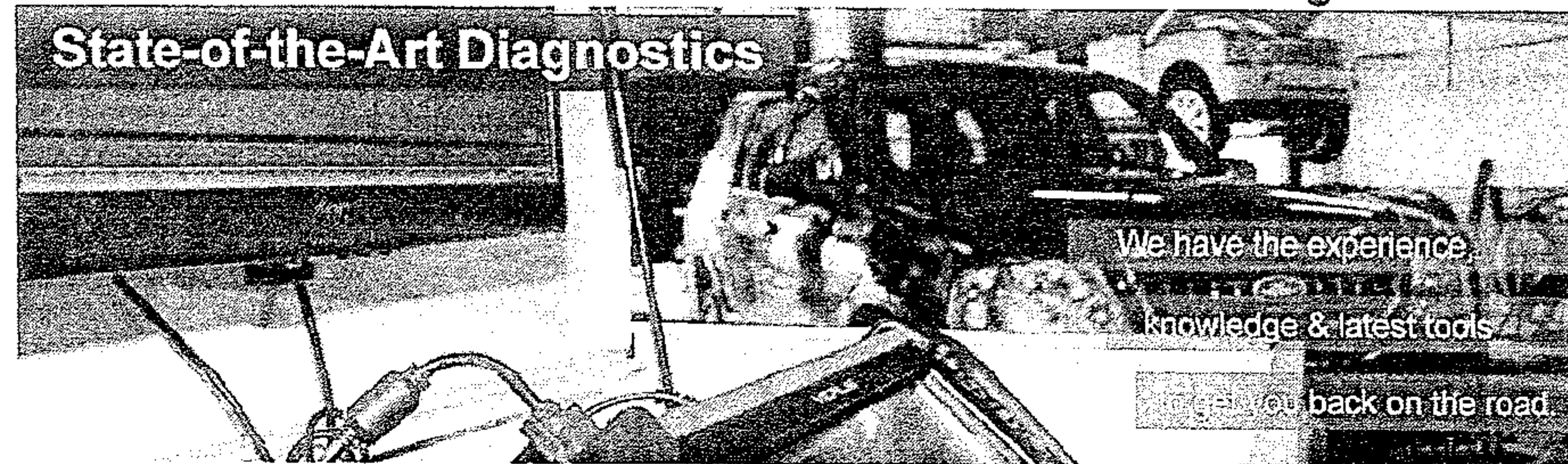
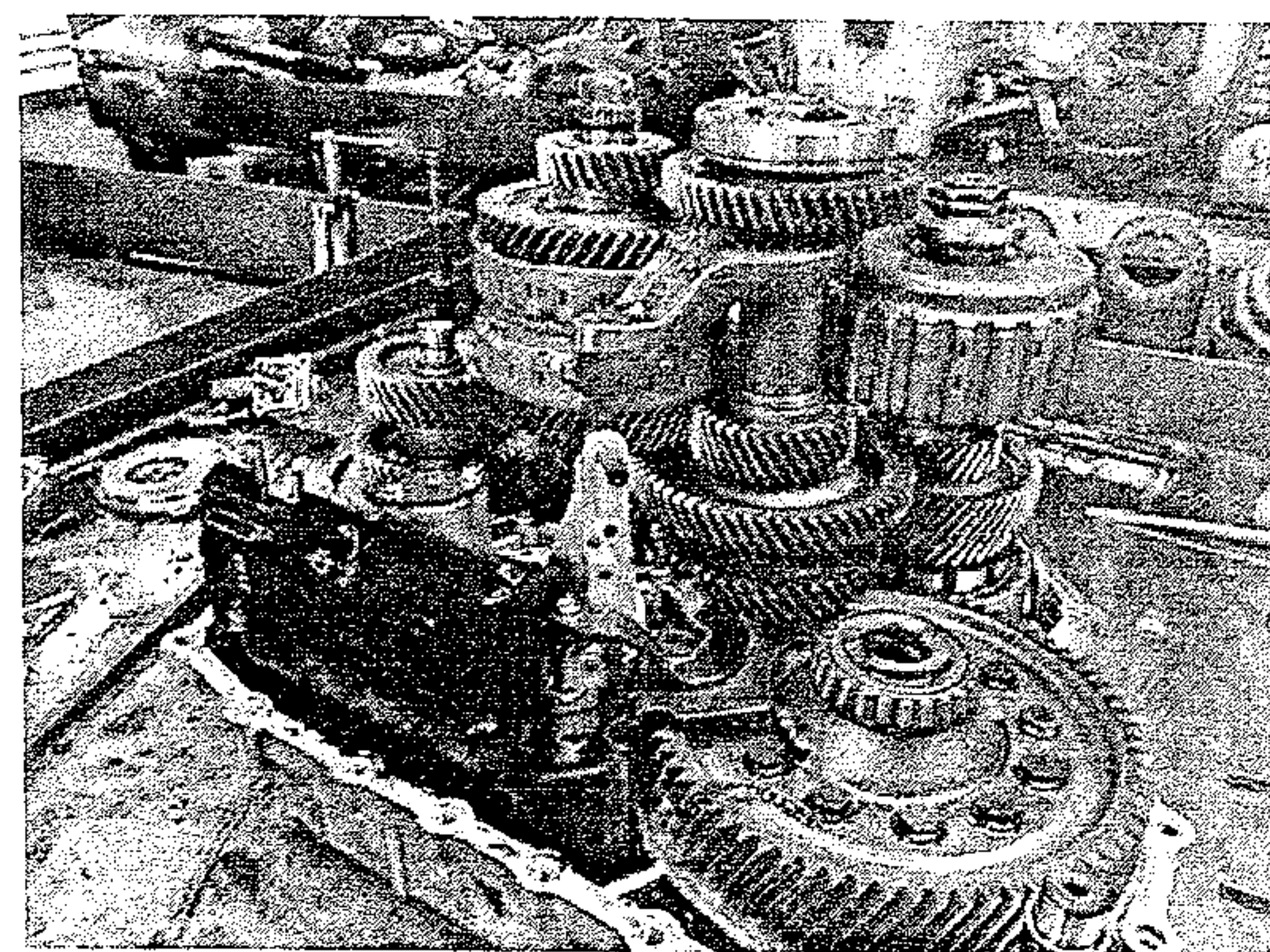

budget-transmissions.com



Approved Auto Repair



DV

Joseph Landreth, 41, Murry Chapel Road Sweetwater, was charged with Domestic Assault and Violation of Probation.

Deputy Billy Lewis LCSO, was dispatched to Murrys Chapel Road for a domestic assault. Upon arrival Deputy made contact with the victim who stated that she and her boyfriend Mr. Joseph

Scott Landreth got into an argument over children which then grew into a scuffle in the living room at which time Mr. Landreth pushed her down onto the couch got on top of her and while he had her pinned down he put his hand over her mouth so that she could not scream. Victim stated Mr. Landreth had been drinking since about 15:00 stating that he also knocked the TV

off into the floor and kicked it with his foot destroying it. Victim was able to get outside at which point Mr. Landreth came outside the residence locking the door behind himself to keep victim out of the residence.

Victim stated when Mr. Landreth discovered she had called the police he threw her purse and walked away from the scene towards the woods.

Deputy Billy Lewis found Mr. Landreth laying about 15 yards in the woods flat of his back. Upon asking Mr. Landreth why he was laying in the woods he stated to avoid conflict. Mr. Landreth had a strong odor of Alcohol coming from his person along with blood shot eyes. Mr. Landreth also had a warrant out of Loudon County General session for VOP warrant

and a Larceny warrant out of Rhea County warrant.

Deputy Billy Lewis LCSO, took Mr. Joseph Landreth into custody for Domestic assault and the warrant out of Loudon County and Rhea County and transported him to the Loudon County Jail without further incident.

FBI ctd.. from pg. 4

used to restrain Reid are also on display.

"After 9/11, the FBI's mission changed substantially to prevent another terrorism attack," Kortan said. "The Newseum exhibit captures a fascinating part of that transformation."

For more information about the "Inside Today's FBI" exhibit, visit the Newseum's website.

Loudon County Sheriff's Office Toys for Tots 2015

Thanks to the generosity year after year of the Loudon County residents, churches, businesses and industries, the Loudon County Sheriff's Office is once again able to offer the Toys for Tots program. We are beginning our 31st year of providing toys to the needy children of Loudon County, and thanks to generous contributions of time, money and gifts, we are able to make Christmas a more joyful time for more and more children. In 2014, approximately 500 children were helped by the Loudon County Sheriff's Department Toys for Tots program through their partners. Even with the difficult economic times

(see T4T ctd.. pg. 8)

PURDY'S AUTO PARTS AND SALVAGE

WE BUY SCRAP IRON • COPPER • BRASS • ALUMINUM

\$

Paying Top \$\$\$

Call For Latest Prices

You Name It, We Buy It!

Radiators, Wheels, Batteries, Appliances, Farm Equipment

Copper

Paying Top \$\$\$

Call For Latest Prices

You Call We Haul!

423-519-5402



* Prices subject to change with the market.

423 337-3977

149 County Road 323 Sweetwater

Complete Cars

per 100 lbs.

Scrap Metal

Paying Top \$\$\$

Call For Latest Prices

per 100 lb

We Buy Batteries

Aluminum Cans

Paying Top \$\$\$

Call For Latest Prices

**Now Selling
Aftermarket
Body Parts at
Discount Prices**

* Prices subject to change with the market.

fight

and a Ashley Nicole Claxton.

Officer Investigation and Ashley Nicole Claxton statement determined that Ahsley Nicole Claxton had gotten into an argument with her boyfriend the victim which led to a physical fight resulting in Ashley Nicole Claxton striking victim numerous times.

Ashley Nicole Claxton was determined to be the primary aggressor and was placed under arrest for domestic assault and transported to the Loudon County Jail.

Officer Bobby Lankford LPD, made the arrest.

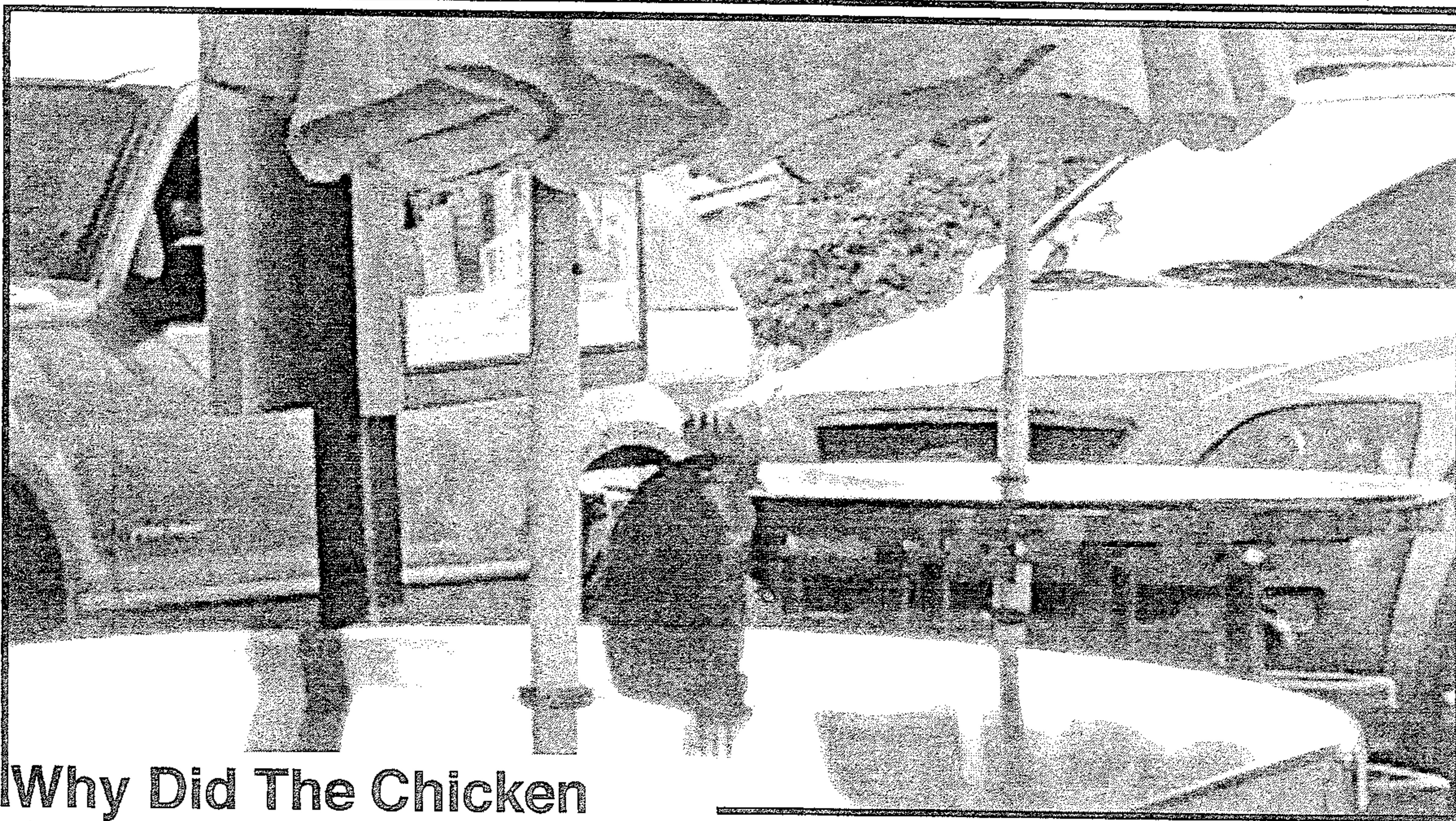

Why Did The Chicken Cross The Road?

Well to get to Sonic during Happy Hour of course! What did you think? This guy can be seen each day at the Lenoir City Sonic just "peckin around" but this time he was "table ready"! You know that's funny I don't care who ya are!

Is Your Washer Broken?
Call Me I Only Charge \$100 Period!!!
Call Allen 865-617-7113

LOOK! \$75 Weekly Payments LOOK!
 MARTY'S AUTO SALES • 986-2222 • MARTY'S AUTO SALES • 986-2222 • MARTY'S AUTO SALES • 986-2222 • MARTY'S AUTO SALES • 986-2222 • MARTY'S AUTO SALES •

Bad Credit
Divorce
Fixed Income
Repos
Bankruptcy
No Credit

APPROVED!

Visit Us On The Web At:
martysautosales.net

NO CREDIT CHECKS

 <p>\$499 down*</p> <p>07 Cobalt, 5spd, gas saver, runs great Only \$499 down*</p>	 <p>\$499 down*</p> <p>02 Sable, sunroof, loaded, Only \$499 down*</p>	 <p>\$499 down*</p> <p>04 Cavalier, 2dr, Sporty, Only \$499 down*</p>	 <p>\$499 down*</p> <p>01 Sebring 2dr. sporty, Only \$499 down*</p>
 <p>\$299 down*</p> <p>97 Escort, auto, Gas Saver, Only \$299 down*</p>	 <p>\$499 down*</p> <p>03 Focus 5 speed, Gas Saver Only \$499 down*</p>	 <p>\$399 down*</p> <p>01 Venture, 7 passenger, Runs Great Only \$399 down*</p>	 <p>\$499 down*</p> <p>00 Ram, High Top Conversion Van, Loaded only \$499 down*</p>

NO Credit Checks

Marty's Auto Sales
986-2222 *Se Habla Espanol*

100% Approval*

*See Dealer for details. All down payments plus tax, tag, title and fees.

MARTY'S AUTO SALES • 986-2222 • MARTY'S AUTO SALES • 986-2222 • MARTY'S AUTO SALES • 986-2222 • MARTY'S AUTO SALES • 986-2222 • MARTY'S AUTO SALES •

T4T etd. from pg. 5

we are experiencing, we hope that the people of Loudon County will be there once again to help.

Names will be available beginning in mid-October through business and churches. If you are considering helping a child this Christmas, please be assured that applicants are thoroughly checked to

make sure they require this assistance. Names are also compared with the school systems to make sure no one is receiving duplicate assistance.

If your business or church would be willing to take names please call Debbie Hines, Toys for Tots Coordinator at 986-4823.

LONNIE JONES OPTICAL DISPENSARY

"We Make The Difference You Can See"
Locally Owned and Operated

Over 1000 Frames To
Choose From
No Frame Over \$69.00



On the corner of A & Depot Street, Lenoir City

986-7803

Serving Loudon County for over 40 years

A Name You Already Know And Trust Just Got Even More Dependable DEPENDABLE AUTO SERVICE, LUBE AND TIRES is Now Offering Expert, Affordable Transmission Service

All ASE Certified Technicians

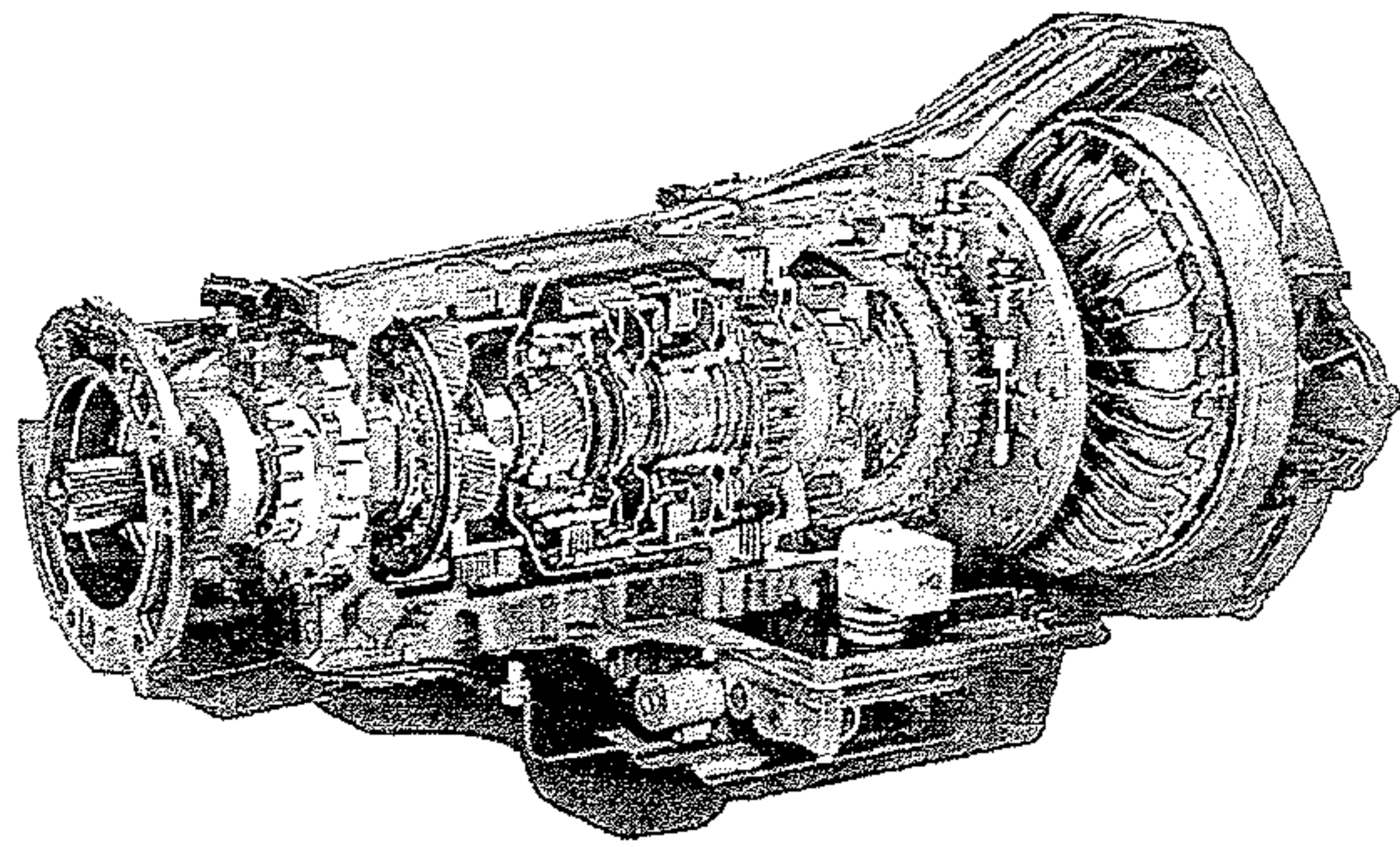

We proudly welcome all New Customers
and Former Advanced Transmission
Customers with a 10% Discount and Any
Transmission Service or Repair*

865-986-9359

865-986-5050

Bad Credit, No Credit OK!!! We Finance Everybody!!!

Low Down Payment!!!

Over 100 Cars, Trucks & Vans in Stock - Warranties On ALL Vehicles Sold!!!

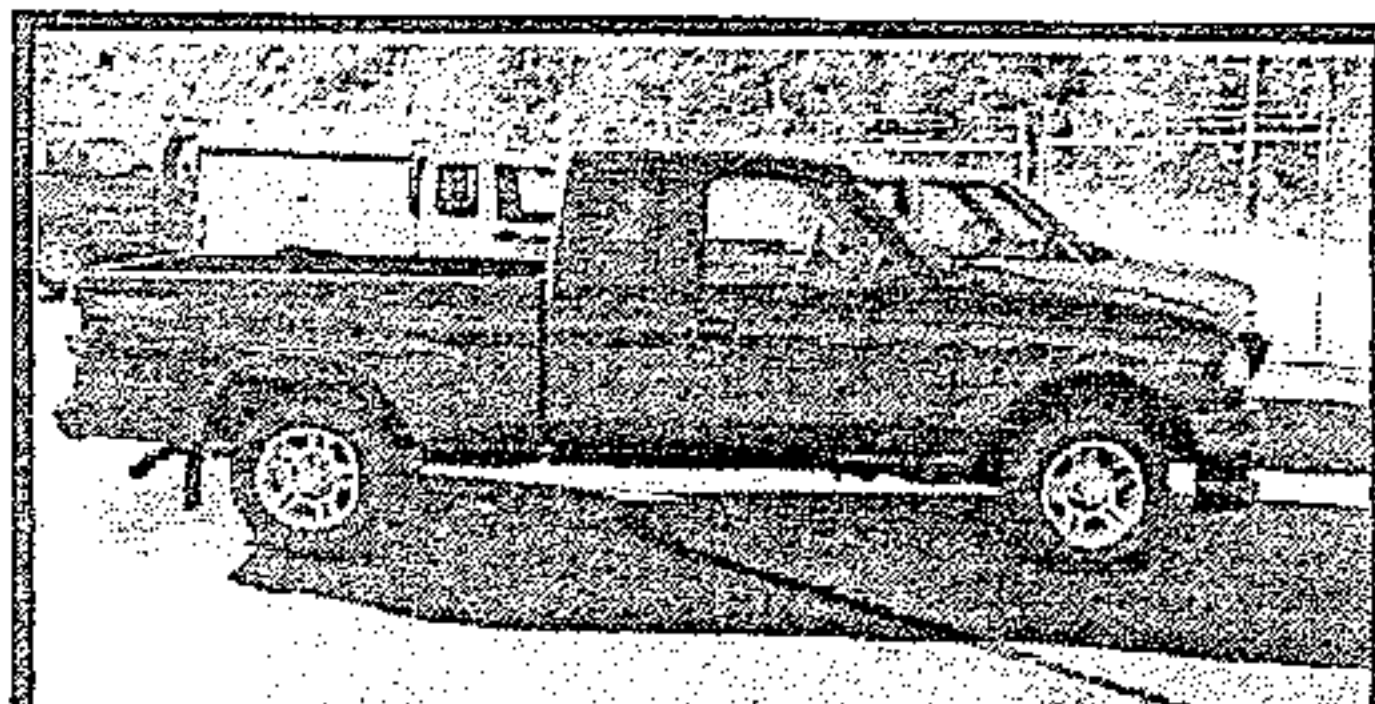

2005 Ford Ranger, Super
Nice Truck. Very Low Miles

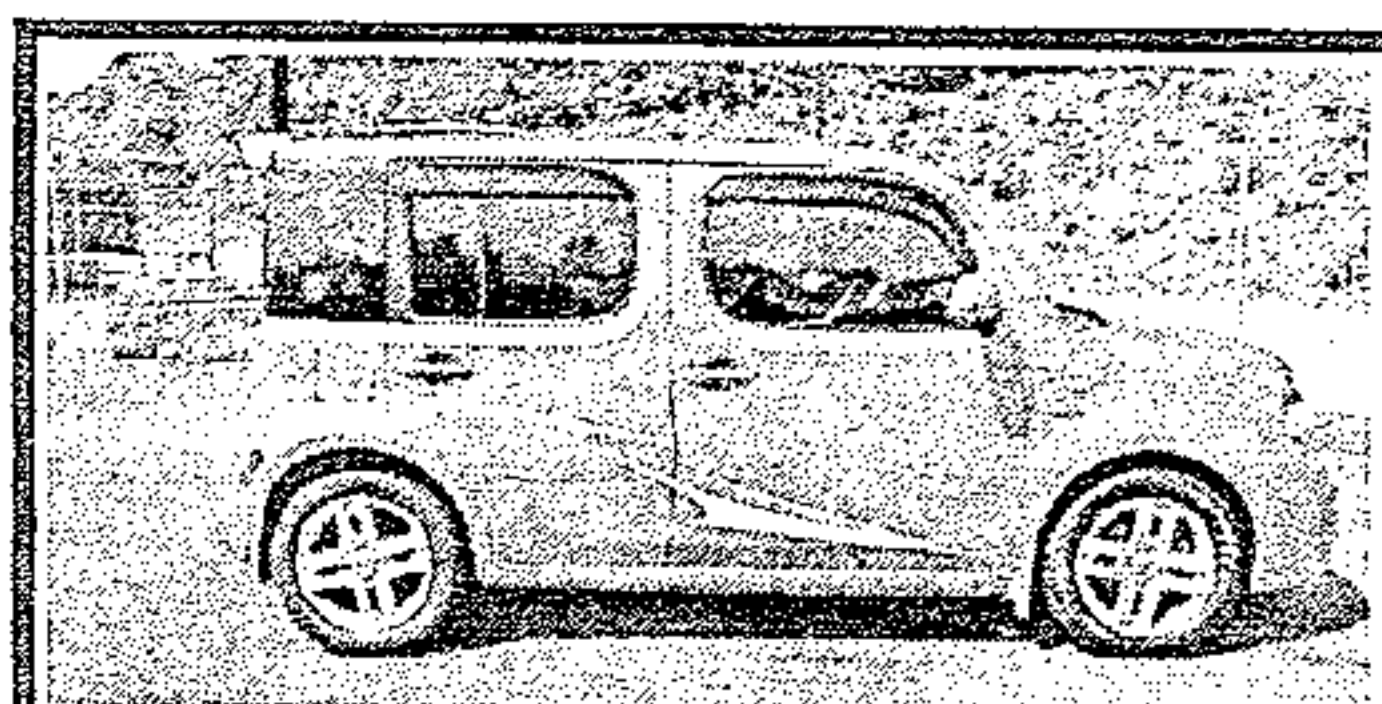

2009 Nissan Cube, Great
Gas Saver, Clean



2010 Ford Ranger, nice truck,
low miles, extended cab



2006 Chrysler 300, Loaded,
Nice Ride

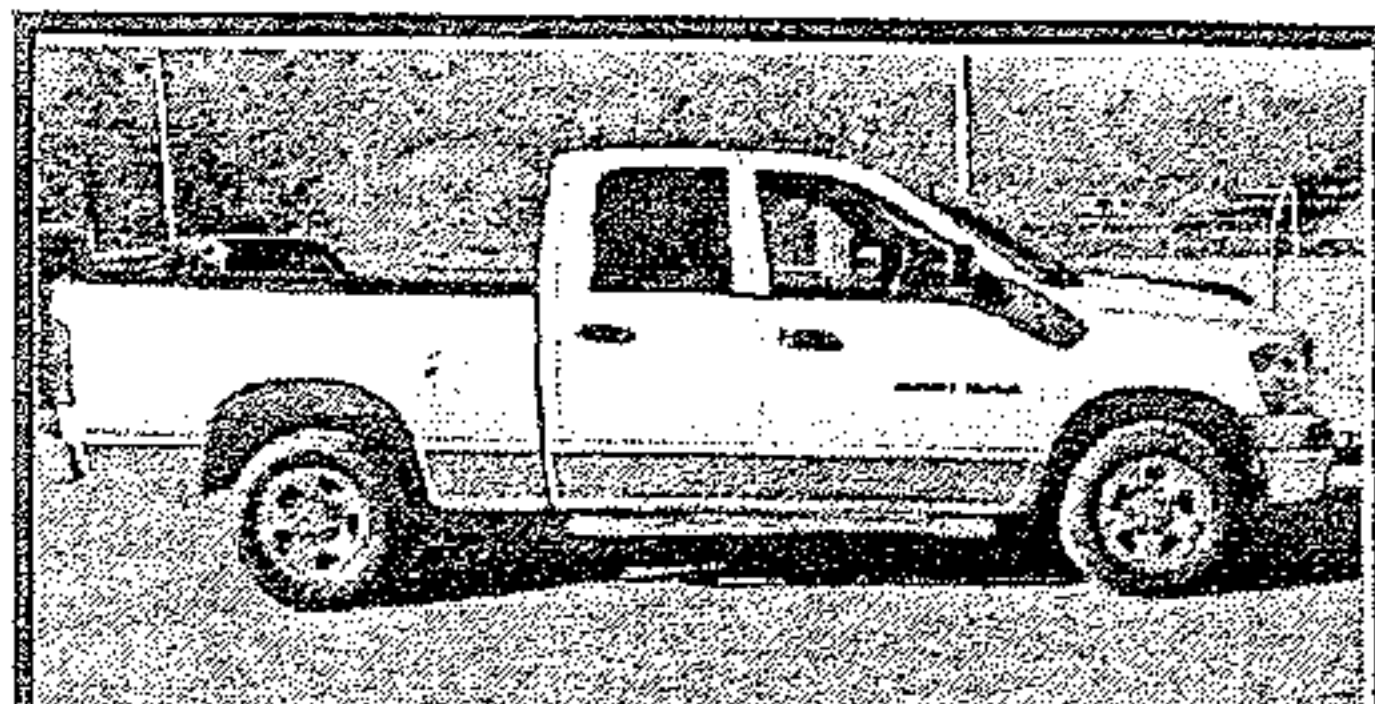

2010 Dodge Ram, 4dr, Great
Work Truck, lots of room

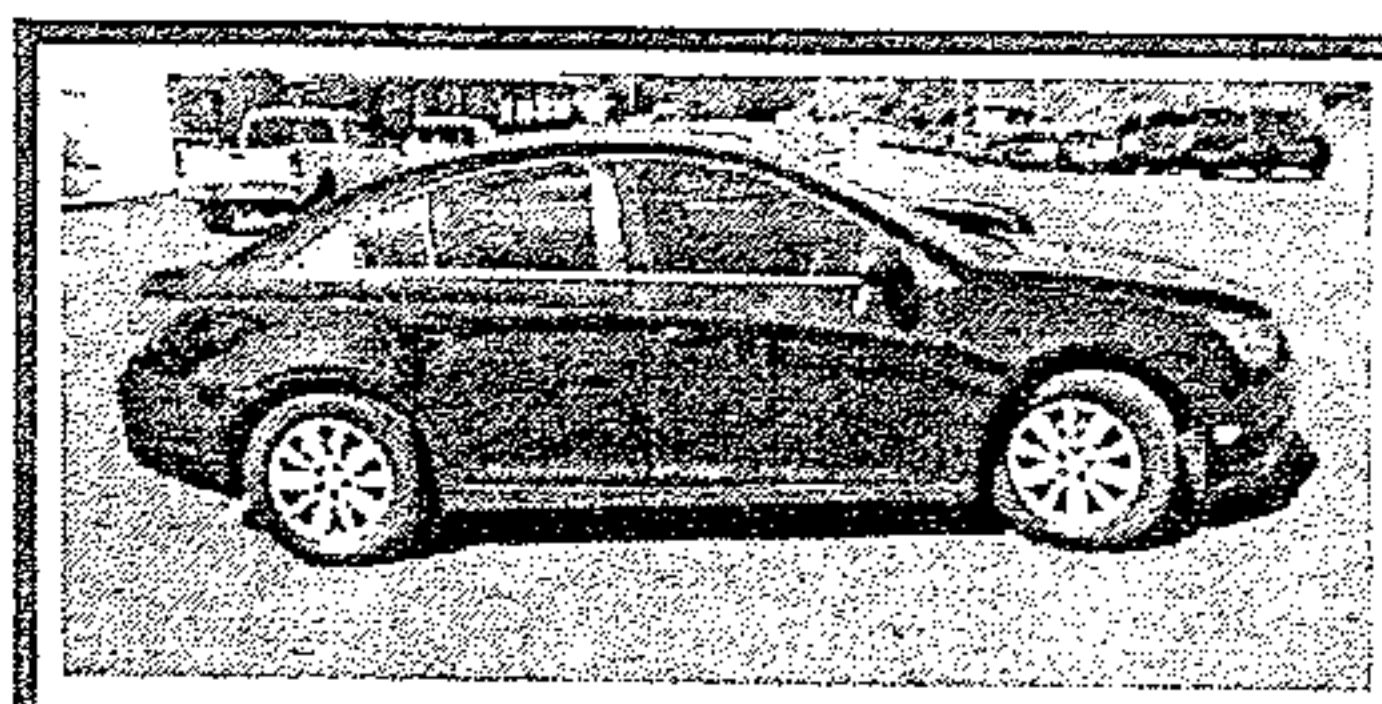

2011 Chevrolet Cruze, LOAD-
ED!!!

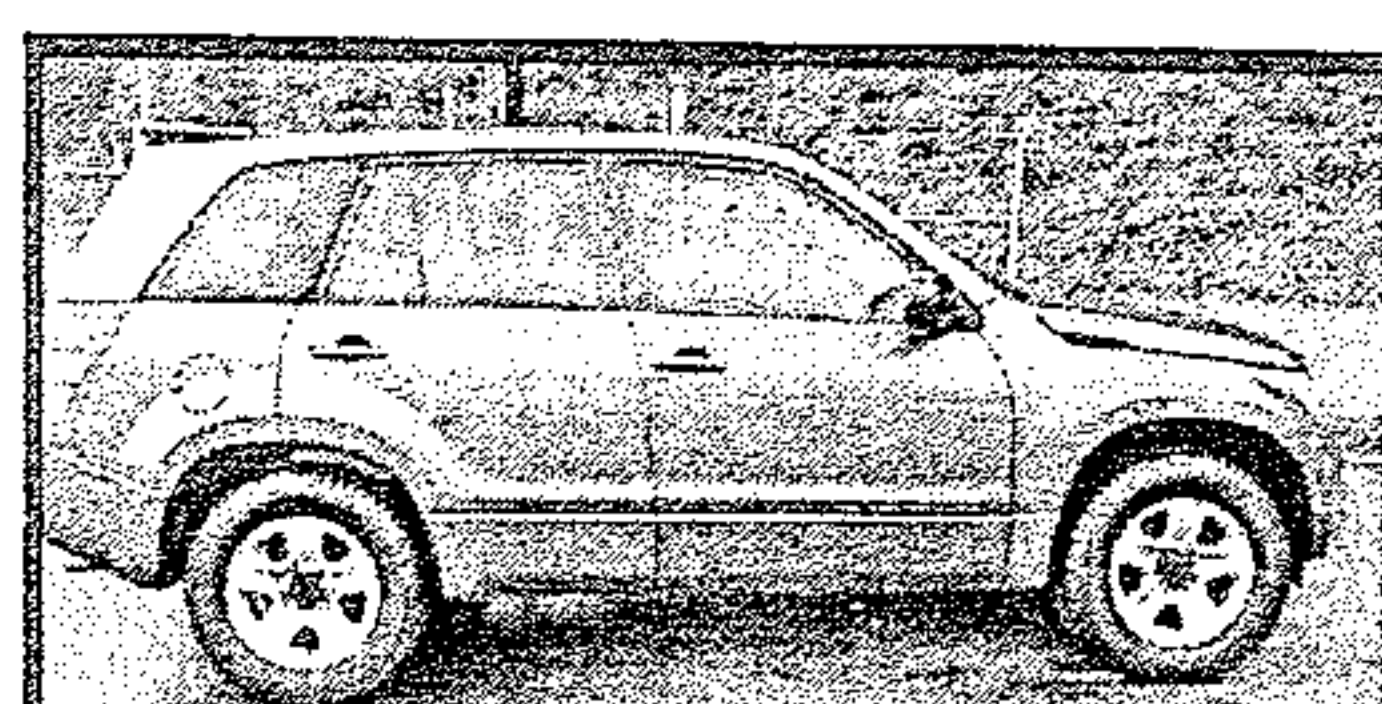

2007 Suzuki Grand Vitara, V6,
Nice!

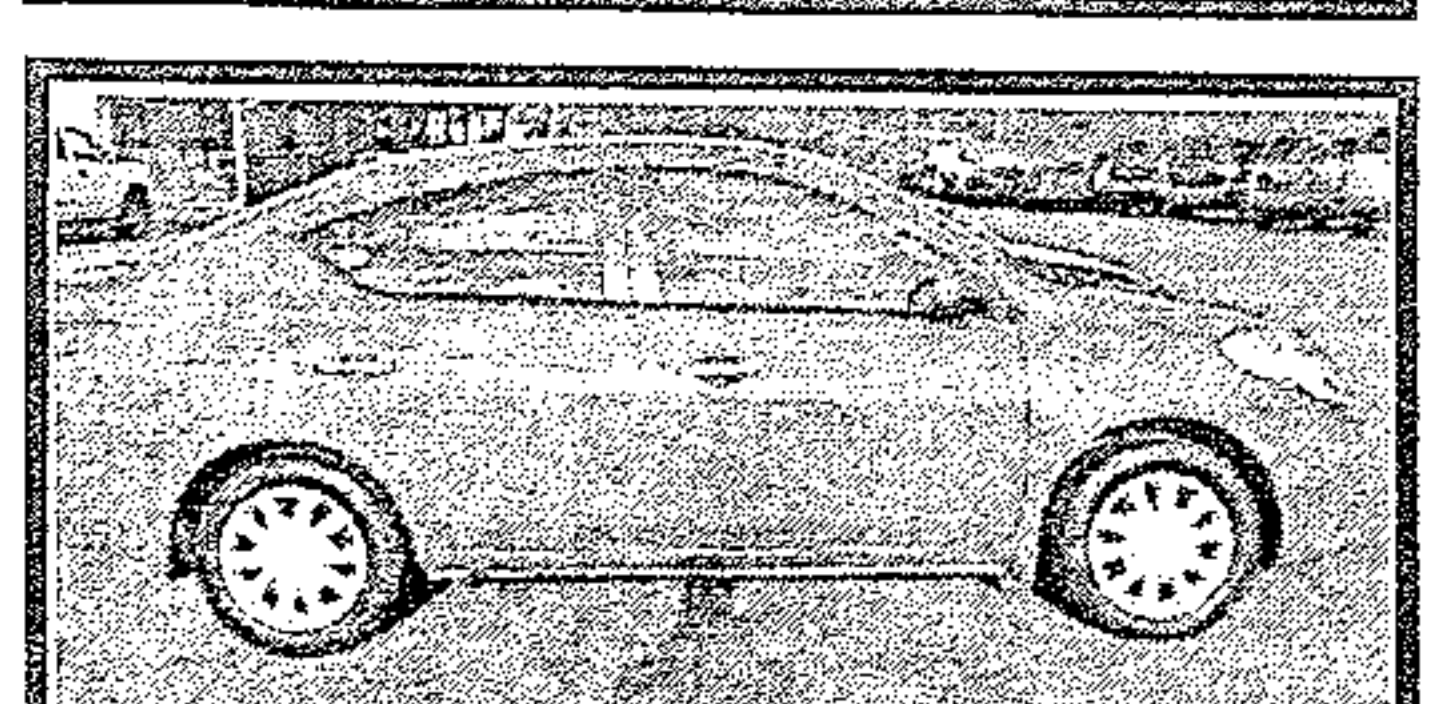

2013 Nissan Versa, Like New!
LOADED!!!

WALT WILLIAMS, INC.

*with approved credit

3003 Highway 11

Lenoir City, TN

865-986-1111