

# The Daily Edition

50¢

Serving Loudon, Monroe and Surrounding Counties

Friday, November 13, 2015

Victim suffers severe beating and choking

Man charged after threats to kill one and slap another

Charges placed after reported suicide attempt



Fred Bridges

(see assault pg. 3)



Eugene Akins

(see threats pg. 2)



Anthony Bright

(see charges pg. 5)

## Reckless driver decides to urinate in patrol car after resisting

Whitney Washington, 27, Mountain Pass Lane Knoxville, was charged with DUI, Violation of Implied Consent, Resisting Arrest, and Aggravated Assault. Deputy Kenneth Palmer LCSO, was dispatched to a reckless driver on Hwy 444 going toward Tellico Village. Dispatch advised the complaint was behind

(see Reckless pg. 7)



Whitney Washington

## Missouri Woman Sentenced for Defrauding Service-Disabled Veteran-Owned Small Business Program

A Missouri woman was sentenced Tuesday to 20 months in federal prison for defrauding a federal program that set aside contracts for businesses owned by service-disabled veterans, U.S. Attorney Barry Grissom said. In addition, she was ordered to pay a \$30,000 money judgment.

Mary Parker, 70, Blue Springs, Mo., pleaded guilty to one

count of aiding and abetting wire fraud. In her plea, she admitted she assisted her husband, Warren Parker and her son, Michael J. Parker, in making false claims in order for their company, Silver Star Construction LLC of Blue Springs, Mo., and Stilwell, Kan., to obtain more than \$6.7 million in contracts from the Veterans Administration. The con-

(see sentenced pg. 4)

### Verse of the Day

Thanks be to God, who always leads us in triumphal procession in Christ and through us spreads everywhere the fragrance of the knowledge of him. — 2 Corinthians 2:14

### Obituaries

see inside **Wazzup**

If you haven't tried out the We're Cooking on Hwy 321 in Lenoir City you definitely should, it's great and they have a food challenge!

### Weather

Today: A mainly sunny sky. High 59F.  
Tonight: Clear skies. Low near 35F.  
Saturday Sunny skies. High 56F.  
Saturday Night Clear skies. Low 34F.  
Sunday A mainly sunny

sky. High around 60F.  
Sunday Night A mostly clear sky. Low 38F.  
Horoscopes  
*Scorpio 10/23-11/21*  
Understanding where your life is leading these days is a real mystery;

(Continued on page 6)

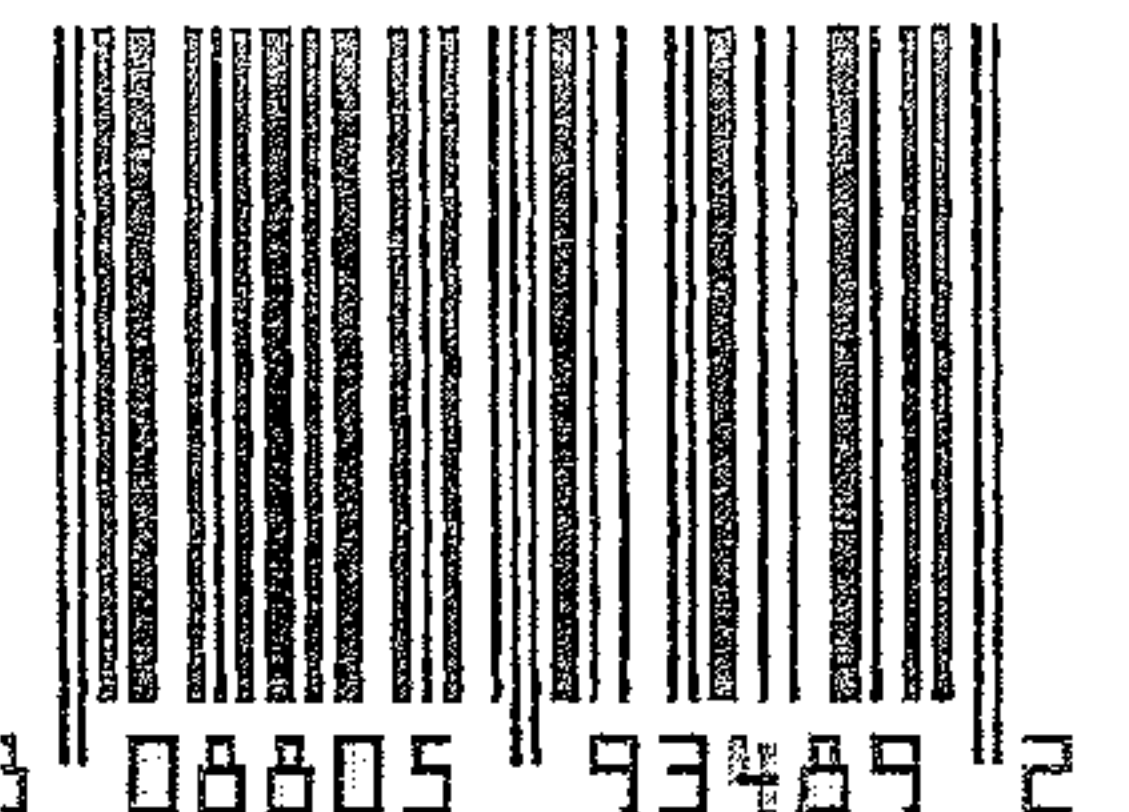

3 08805 93489 2

threats

Eugene Akins, 64, Rest Camp Road Lenoir City, was charged with Domestic Assault.

According to the report, Deputy Kevin Parks LCSO, was dispatched to Rest Camp Road on a disturbance call. Victim stated to Deputy that Eugene Akins had called 911

in reference to the victim and his girlfriend arguing. Upon talking with the victims and written statements, victim stated that Eugene had threatened to get a gun and shoot victim.

Victims stated that Eugene started yelling and told then he was going to kill one and slap the other.

Deputy spoke with Eugene

who stated he was going to kill the victim. Eugene was determined to be the primary aggressor and placed under arrest.

Deputy Kevin Parks LCSO, made the arrest.

**Notice**  
 Vin 1G82557N87F202859  
 General Motors Vehicle will be sold. If anyone has a lien on this vehicle contact: Homer's Body Shop, 10609 Beals Chapel Road, Lenoir City, 37772, 865-388-0372.

Notice: The Daily Edition does not knowingly accept fraudulent or misleading materials. The Daily Edition cannot guarantee the validity of offerings or statements contained herein. All liability for the contents of all advertising, and for any claims that may arise therefrom, is the responsibility of the advertiser or its agency. The Daily Edition reserves the right to reject, edit, or abbreviate any advertisement submitted. Advertising is accepted with the understanding that all liability for all copyright violations is the sole responsibility of the advertiser. Photographs, artwork and other copy submitted for publication is considered the sole property of the advertiser. The Daily Edition will make every effort but will not be liable for failure to publish and ad or for typographical and layout errors. All statements and information about highlights featured items, letters to the editor, herein are those solely given to the interviewer or writer and the Daily Edition assumes no responsibility of the accuracy or validity thereof. The Daily Edition will gladly reprint at no charge that part of an advertisement in which an error occurs provided a claim is made within 3 days of the first publication of the ad. Information contained in the Wazzup is received anonymously and the Daily Edition assumes no responsibility for information and reserves the right to edit or reject any and/or all submissions. The Daily Edition is a daily newspaper of general circulation in Loudon County defined under TCA 2-1-104(a)(13). The Daily Edition also serves Monroe, Knox, Anderson, Roane and Blount counties and serves 30,000 readers weekly. Send mail to PO Box 1240, Lenoir City TN 37771. 865-771-2249. email: dan1204us@yahoo.com  
 The Daily Edition is Loudon County's premier public interest and paid advertising paper. The Daily Edition is produced and published daily Monday through Friday and is circulated throughout Loudon County and parts of Monroe and Knox Counties. Display advertising rates \$5.00 per column inch and quantity discounts available. Call for information on upcoming promotions and events.

**HACIENDA Ayala's**  
**Mexican Restaurant**  
 Market Dr. \* Lenoir City (In Front of Food City)

**Real Authentic Mexican Food at Affordable Prices**

**BEST MARGARITA**

You've Tried The Rest  
 Now Come Have The Best!!!

We Accept ALL Competitors Coupons Outside of Mexico City!

986-3553



**Good Credit OK • Bad Credit OK • Bankruptcies OK • Repo OK**



2010 Kia Soul Sporty, 4 cyl, Auto, PW, PL, A/C, Great On Gas, Like New



2010 Ford Escape Limited Leather, Alloy Wheels, Heat, A/C, Luggage Rack, 79K,



2007 Dodge Ram 1500 Quad Cab, Thunder Road PKG, 20 in. Wheels, Low Miles, Hemi



2008 Ford Explorer 84k, 3rd Row Seating, Luggage Rack, Tow Pkg, PW, PL



2011 Ford Ranger Low Miles, Tow Pkg, New Tires, A/C, Heat, Bed Liner.



2011 Dodge Grand Caravan DVD, Stow & Go, Loaded, Remote Doors, Rear A/C

**DEPENDABLE MOTORS 986-9343**  
 803 E. Broadway • Lenoir City

*Serving Loudon County for 20 Years*

\* WAC. See Dealer for details

Visit our website at: [www.dependablemotorslc.com](http://www.dependablemotorslc.com)

**assault**

Fred Bridges, 28, Harmon Lane Lenoir City, was charged with Aggravated Assault. Deputy Charlie Huskins LCSO, was dispatched to a domestic taking place at Harmon Lane. When Deputy arrived on scene no one was around the scene. After further investigation Deputy was able to find the victim of the incident. The victim stated to Deputy that Fred Bridges had held her against her will, and assaulted her several times, by punching her in the kidney area, trying to choke her out, and throwing her around. Deputy did see several abrasion around the neck area as well as bruising around the left kidney area. Deputy Ronnie Reagan LCSO, located Fred Bridges and made the arrest.

**Obituaries**

Christine (Chris) Haworth -age 45 of Lenoir City, passed away suddenly Thursday, November 5, 2015. She was an employee of Aubrey's Restaurant in Farragut. Chris was a loving and devoted mother to her son, Dylan Haworth. The

family will receive friends from 2 - 3 p.m. Wednesday November 11 at Click Funeral Home in Lenoir City. A memorial service will follow at 3 p.m. in the Click Funeral Home Chapel. A private interment will be held. Click Funeral Home in Lenoir City is in charge of arrangements.

Roy C. Riddle - age 78 of the Alwick Community, passed away Friday, November 5, 2015. Mr. Riddle was an electrician and retired from the Blount County Schools, Maintenance department. A veteran serving in the US

**The Daily Edition**

serving Loudon and surrounding counties since 1986

**For Sale: Oak Wood Mulch**



Mushroom Compost Topsoil.

**Firewood**



Call Steve Spoon 986-4282

Navy. He was preceded in death by his precious wife of 55 years, Katherine (Worthy) Riddle, in July of this year; his parents, John Daniel and Ruby Merritt (Thompson) Riddle; brothers and sisters in-law, Joseph and Jan Riddle, Bill and Jean Cavett; sister and brother in-law, Blanche and Donald Watkins, and infant sister, Katherine. He is survived by his sister and

brother in-law, Margaret and Harold Heiser, Pennsylvania; brother and sister in-law, Glenn and Katherine Riddle, Maryville; several nieces, nephews and friends. Graveside services will be held 2:00 PM Wednesday, November 11, 2015 in the Loudon County Memorial Gardens, 6505 Hwy 11 West, Lenoir City. McGill-Karnes Funeral (see obits ctd. pg. 5)

**West End Storage & Warehouses**  
**502 Ward Avenue • Loudon**  
**Call 865-458-4774 or 865-679-5555**

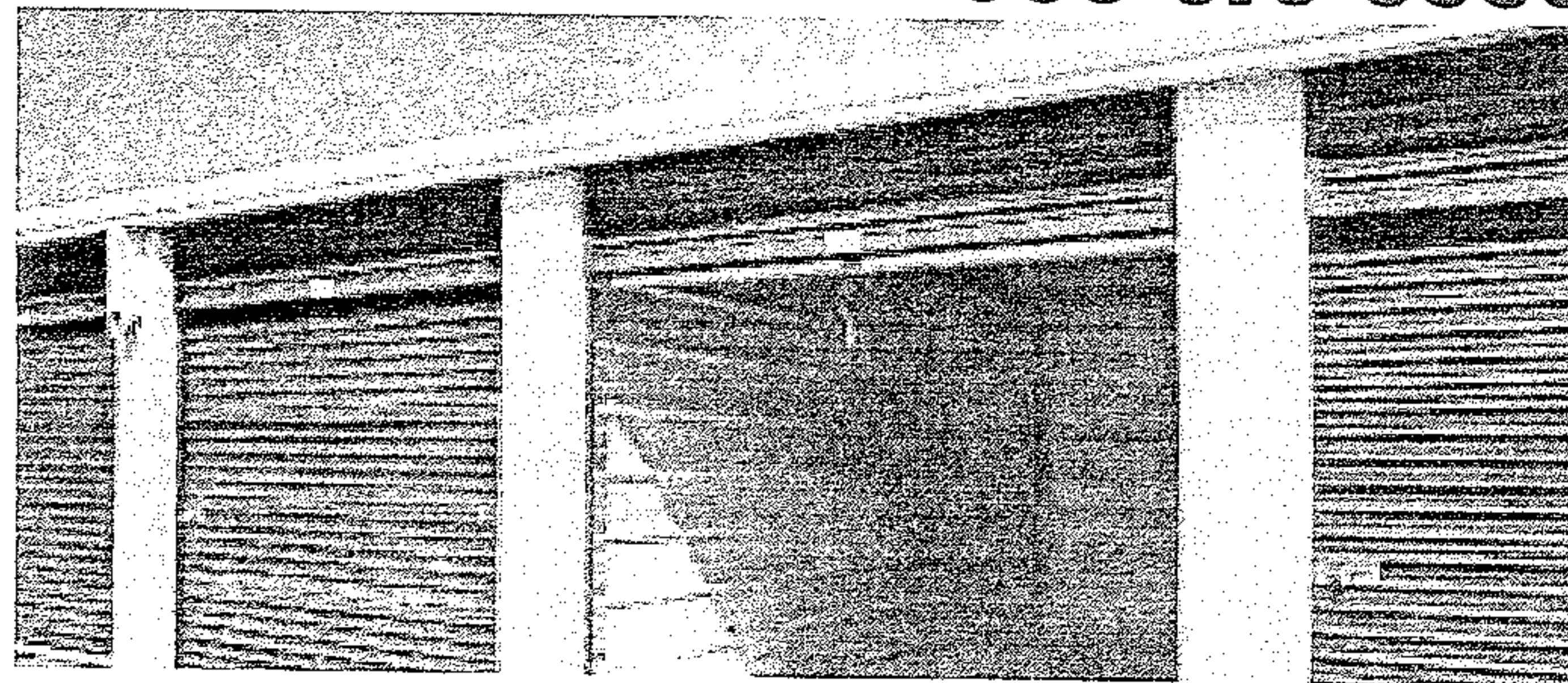

**C&J Towing and Recovery**



**LOWEST TOWING RATES AROUND!!!**

Have you been overcharged for any type of towing service in the Lenoir City area? If you have a breakdown or accident please OWNER REQUEST C&J Towing with the officer. Also please call your Sheriff and ask him to place C&J Towing on the "Rotation List\*" and help other motorists save as much as you did! We at C&J are locally owned and operated, State approved, licensed, bonded and insured. Call and let us know if your denied service or how we can be of assistance.

\*note: the "Rotation List" is a list of wrecker services that provide service for wrecks, DUI's, breakdowns, etc. and are on an on-call basis for service. This list is approved by the Sheriff.

Cliff Teeters • Owner

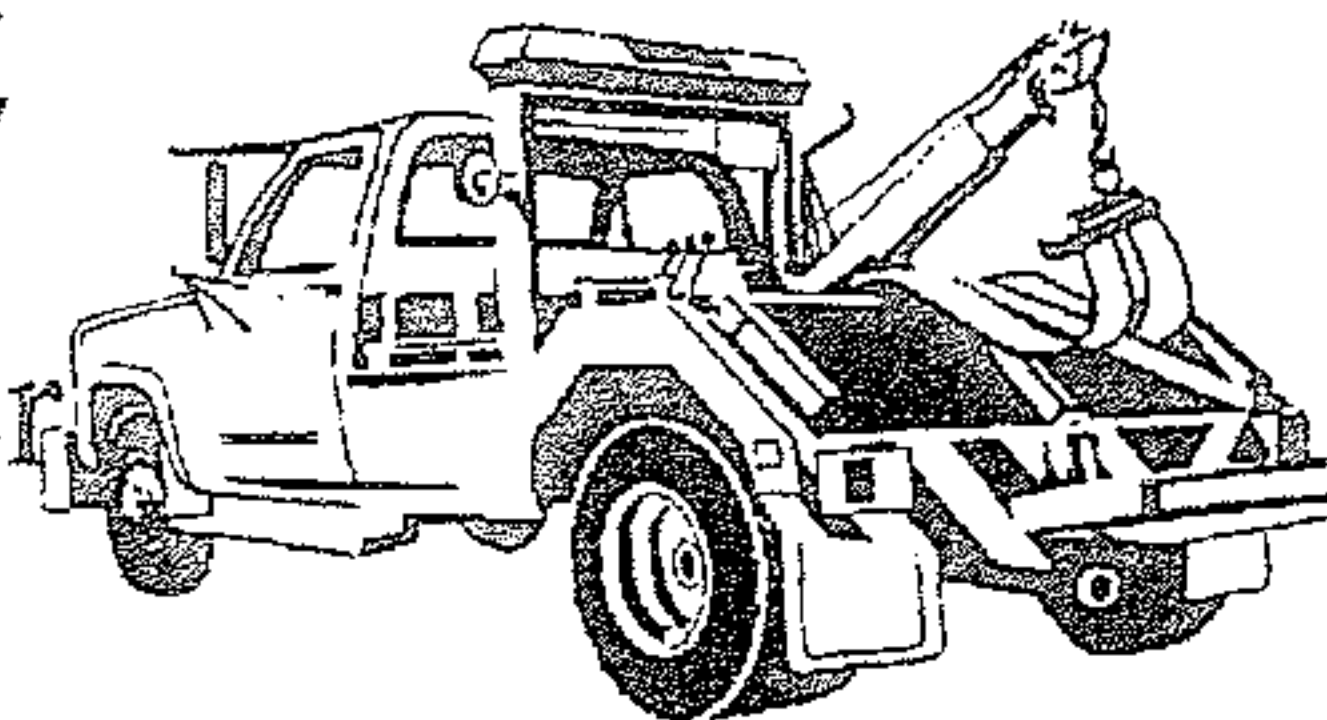
865-809-1661

**BIMBO'S**  
**Deli Open 24 Hours**  
**865-986-9643 Call Ins Welcome**  
**Specials**  
**Lg. Cold Sub, bag of chips and 16 oz. fountain drink only \$6.29**  
**Footlong Corn Dog \$2.59**

sentenced

tracts were awarded under the Service-Disabled Veteran-Owned Small Business Program.

Mary Parker admitted she was responsible for all Silver Star Construction's finances. She accepted monies on the company's behalf that were paid from government contracts that were fraudulently obtained. An investigation by federal agents determined that Warren Parker never was classified as a service-disabled veteran by the Veterans Administration or the Department of Defense.

Warren K. Parker was sentenced to 87 months in federal prison.

Grissom commended the Small Business Administration's

Office of Inspector General; the Defense Criminal Investigative Service; the Department of Veterans Affairs, Office of Inspector General, Criminal Investigation Division and the General Services Administration's Office of Inspector General; and Assistant U.S. Attorney Tris Hunt for their work on

the case.

Loudon County Sheriff's Office Toys for Tots 2015

Thanks to the generosity year after year of the Loudon County residents, churches, businesses and industries, the Loudon County Sheriff's Office is once again able to offer the Toys for Tots program. We are beginning our

31st year of providing toys to the needy children of Loudon County, and thanks to generous contributions of time, money and gifts, we are able to make Christmas a more joyful time for more and more children. In 2014, approximately 500 children were helped by the Loudon County Sheriff's De-

partment Toys for Tots program through their partners. Even with the difficult economic times we are experiencing, we hope that the people of Loudon County will be there once again to help.

Names will be available beginning in mid-October through business and churches. If (see T4T ctd. pg. 5)

**SARCO Enterprises Inc. Offers Complete Home and Commercial Remolding and Repairs**

Our Team members have a combined total of over 40 years experience in all areas of home construction, facilities maintenance and commercial construction. Roofing, Electrical, Bath and Kitchen Renovations, we do it all with just one call. We are fully insured and our work is guaranteed.

Call us today for a free no obligation quote for your next project.  
865-809-9492.

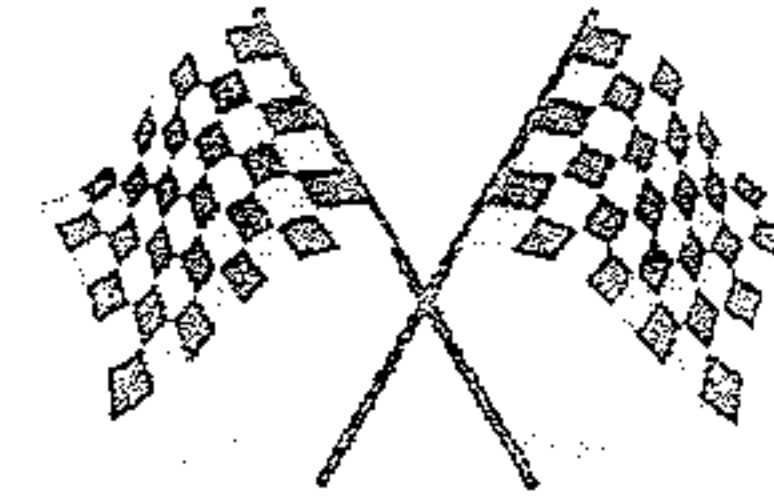

**SOUTHERN AUTO DETAILING**

**414 WEST BROADWAY  
LENOIR CITY, TN 37771  
865-986-0724**

**Starting at \$34.95  
Present this ad for \$5.00 off**

**BUDGET  
Transmissions**

**Why Buy From Budget?**

**Free Towing From Lenoir City  
or Loudon County  
20 Years of BBB Zero Customer Com-  
plaints Award Member  
A+ Plus Rated  
Huge Transmission Inventory  
Best Technicians Period!!!**

**Call (865) 584-4391 Today!**

**302 S. Northshore Drive Knoxville  
(865) 584-4391**

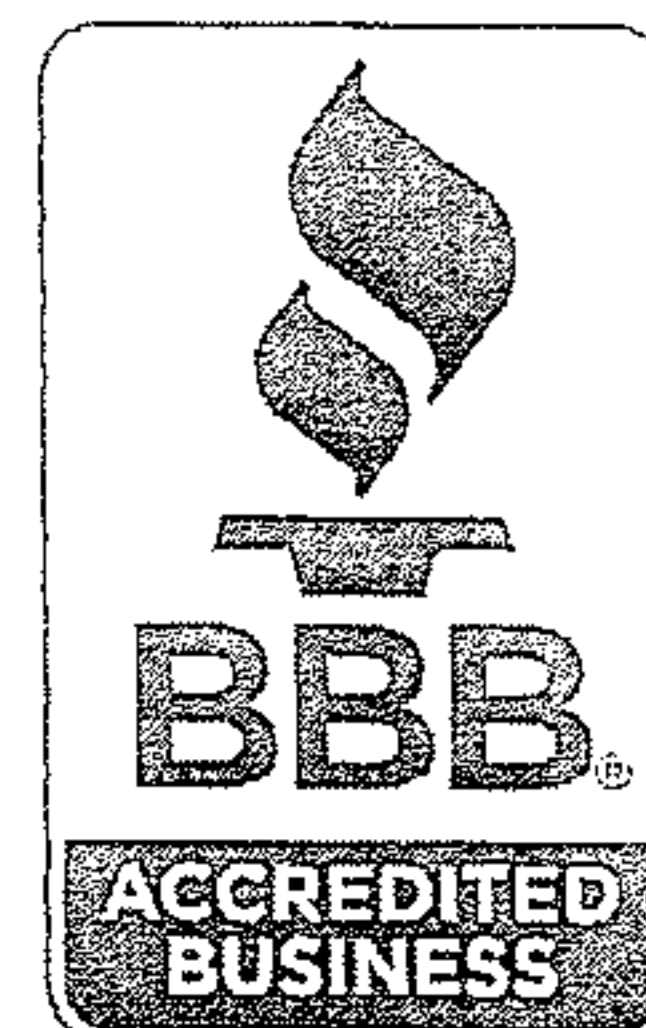
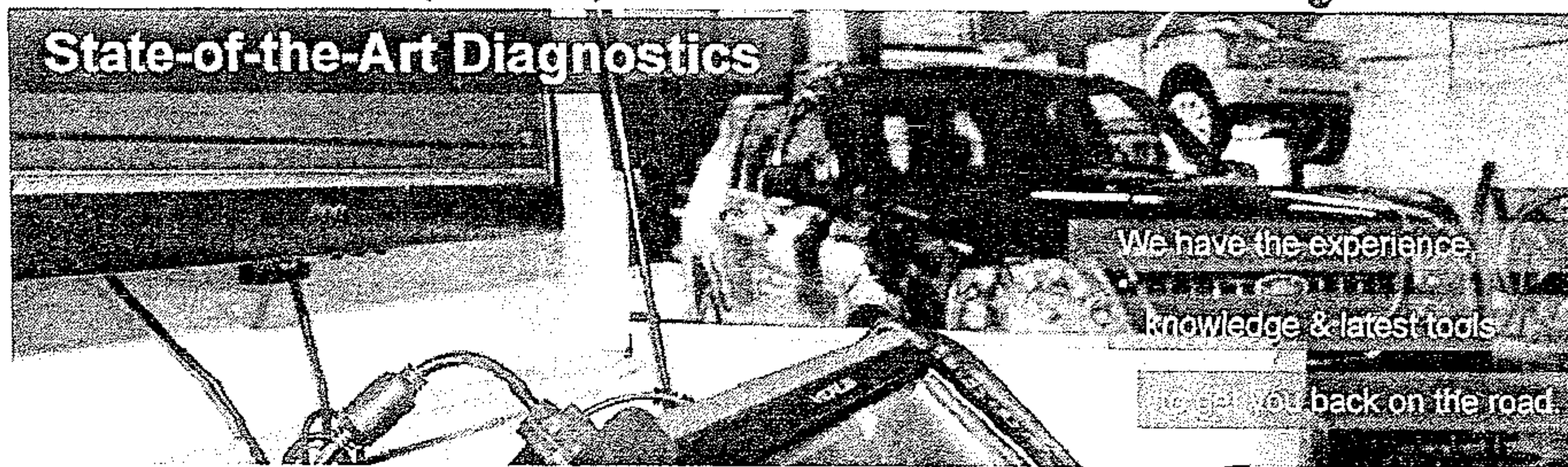
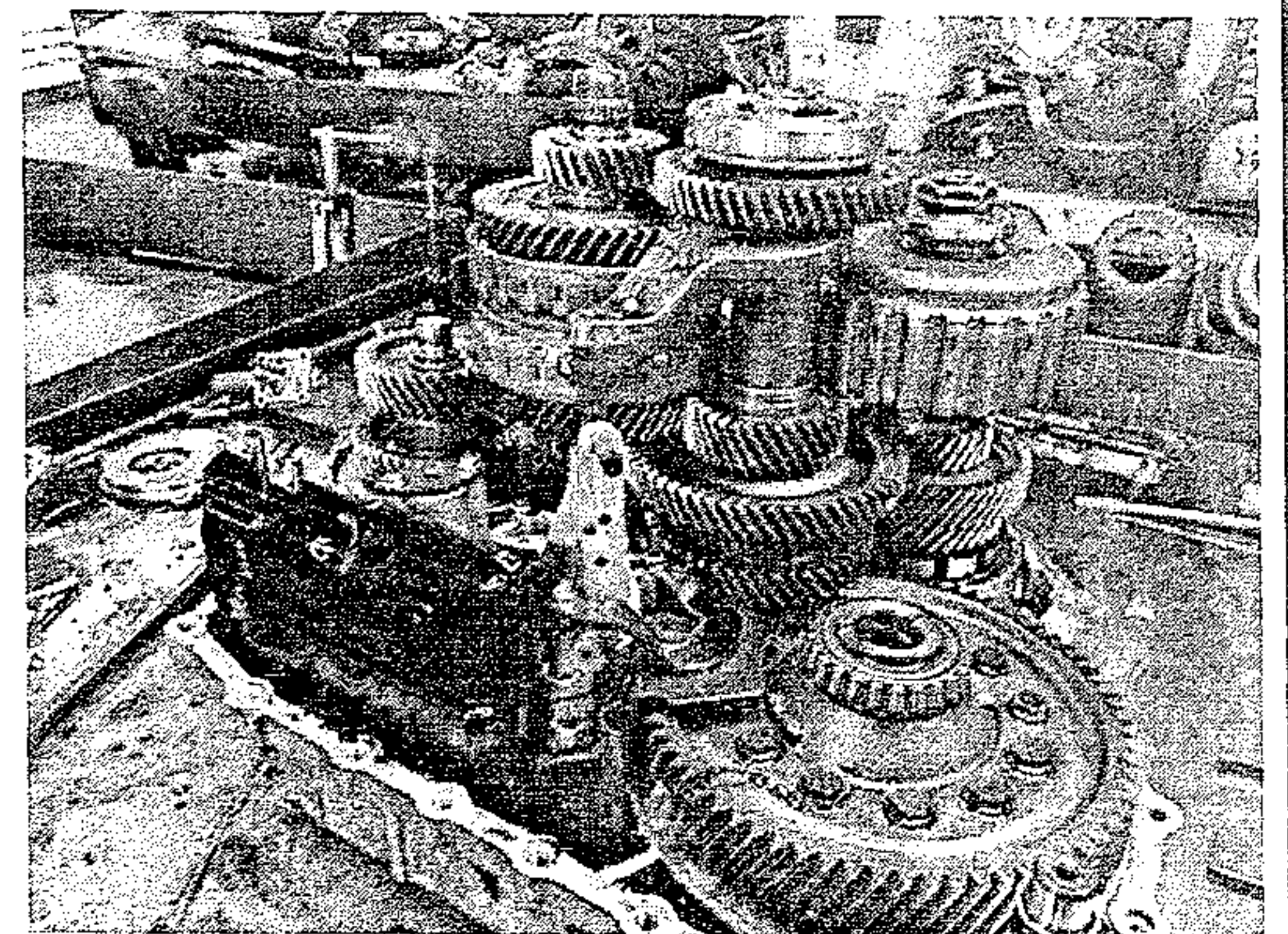

*budget-transmissions.com*



**Approved  
Auto Repair**



**charges**

Anthony Bright, 39, Steekee Street Loudon, was charged with Domestic Assault.

According to the report, Deputy Jamie Ketner LCSO, and Charlie Huskins LCSO, was dispatched to a possible suicide attempt.

Deputy made contact with the parties. Victim stated that they

were arguing. Victim stated that Anthony Bright had pushed her down and she had hit her head on the vent, and Anthony punched her in the back. Victim did have marks on her head and back consistent with her story. Victim was transported to the hospital and Anthony was placed under arrest. Deputy Jamie Ketner LCSO, made the arrest.

Oblits ctd. from pg. 3

Home, Loudon.

Joanne Aldene (Al) Kinser - age 84 of Lenoir City went to be with her Lord on Wednesday, November 11, 2015. Al was a member of Calvary Baptist Church for 62 years. She worked in Quality Control for Genesco. Al was faithful to take care of her grandmother, Stella

Ryan Nichols for many years. She was preceded in death by her parents, Floyd Kinser and Gladys Nichols Stout; half brother, Ron Stout; grandparents, Bill Nichols and Stella Ryan Nichols, Martin (M. L.) and Julia Kinser; several aunts and cousins. Survived by her twin sister, Ernestine (Teeny) Young and husband, Johnny

Young; aunt, Margaret Wells (Ralph); many cousins; special friends, Janice Reynolds, Ken and Jane Ezell. Friends may call at their convenience at Click Funeral Home in Lenoir City. Family and friends will gather at 1 p.m. Friday, November 13th at Click Funeral Home and proceed to the Lenoir City Cemetery for graveside services at 1:30 p.m. with Rev. Jim Best officiating. In lieu of flowers, memorials may be made to East Tennessee Children's Hospital, 2018 West Clinch Avenue, Knoxville, TN 37916. Click Funeral Home, 109 Walnut Street, Lenoir City is in charge of arrangements.

Ads starting at only \$1 per day. Call 865-771-2249

T4T ctd.. from pg. 4

you are considering helping a child this Christmas, please be assured that applicants are thoroughly checked to make sure they require this assistance. Names are also compared with the school systems to make sure no one is receiving duplicate assistance.

If your business or church would be willing to take names please call Debbie Hines, Toys for Tots Coordinator at 986-4823.

**PURDY'S AUTO PARTS AND SALVAGE**

**WE BUY SCRAP IRON • COPPER • BRASS • ALUMINUM**

\$

**Paying Top \$\$\$**

Call For Latest Prices

*You Name It, We Buy It!*

*Radiators, Wheels, Batteries, Appliances, Farm Equipment*

**Copper**

**Paying Top \$\$\$**

Call For Latest Prices

**You Call We Haul!**

**423-519-5402**

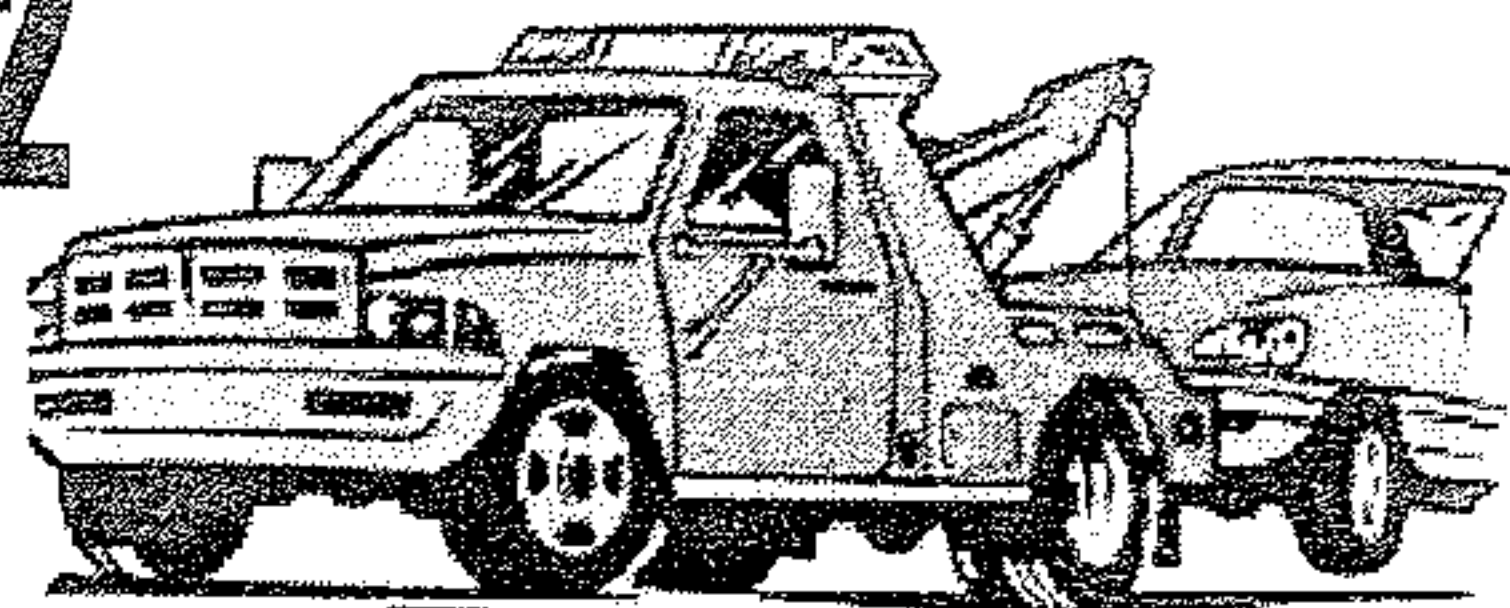

Prices subject to change with the market.

**423 337-3977**

**149 County Road 323 Sweetwater**

**Complete Cars**

per 100 lbs.

**Scrap Metal**

**Paying Top \$\$\$**

Call For Latest Prices

per 100 lb

**We Buy Batteries**

**Aluminum Cans**

**Paying Top \$\$\$**

Call For Latest Prices

**Now Selling Aftermarket Body Parts at Discount Prices**

Prices subject to change with the market.

## Reckless

the vehicle and stated it was a white SUV. Dispatch advised the complainant stated the vehicle was all over the roadway, and almost struck her vehicle. Dispatch advised the vehicle crossed the center line almost striking a vehicle head on. Deputy made contact with the vehicle Maple Hill Road, and it turned into a driveway. Deputy activated his blue lights and made contact with the driver Whitney Washington. While speaking with Whitney Deputy noticed her eyes were red and glassy, Deputy could smell a strong odor of an alcoholic beverage emitting

from the vehicle. Deputy ask Whitney how much she had to drink she stated 2 glasses of wine. Deputy could smell a strong odor of alcoholic beverage emitting from her person. Whitney did poorly on sobriety test and told she was under arrest. While Deputy was trying to place handcuff on Whitney she started pulling away and resisting. While placing Whitney in the patrol car Whitney did kick Deputy in the stomach. Whitney was very uncooperative kicking the window, and urinated in the back of the patrol car. Deputy Kenneth Palmer LCSO, made the arrest.

## How To Design Posters With The Help Of Adobe Photoshop

by: Charen smith

For expert artist and designers, the exciting thing about utilizing personal computer sets is that most of these individuals can now combine the technology with the traditional art without compromising others aspects. Utilizing a computer program such as the Adobe Photoshop will now allow you to do the same things that would have done traditional by some people with a pencil and paper, however, much faster and with less waste materials. Most designers and even you can now redraw and get rid of illustrations and images with the aid of this advanced computer

technology, even in the last phase of the design process, without having to get more pencils and papers.

This goes for all amateur and professional designers like you, you and all others that are more often than not making business marketing materials such as stickers, postcards and especially posters can now make use of the steps that is printed in this article for you to cut down on printing cost and especially on waste materials.

You will also accomplish plenty of time when it comes to setting up something errors with

the aid of these programs. To further improve your know how about these things, below are some of the fundamental steps that you can consider every time you are designing your print materials with the aid of the Adobe Photoshop.

The sketching in Photoshop most of the professional designers usually believes that the process of sketching is similar when it comes to traditional and digital art. The palette graphics of this program almost replicates the feeling of the drawing on paper materials. However, the

(see Posters ctd. pg. 8)

### Is Your Washer Broken?

Call Me I Only Charge \$100 Period!!!

Call Allen 865-617-7113

**LOOK!**

**\$75 Weekly Payments**

**LOOK!**

MARTY'S AUTO SALES • 986-2222 • MARTY'S AUTO SALES • 986-2222 • MARTY'S AUTO SALES • 986-2222 • MARTY'S AUTO SALES • 986-2222 • MARTY'S AUTO SALES • 986-2222 • MARTY'S AUTO SALES • 986-2222

Bad Credit  
Divorce  
Fixed Income  
Repos  
Bankruptcy  
No Credit

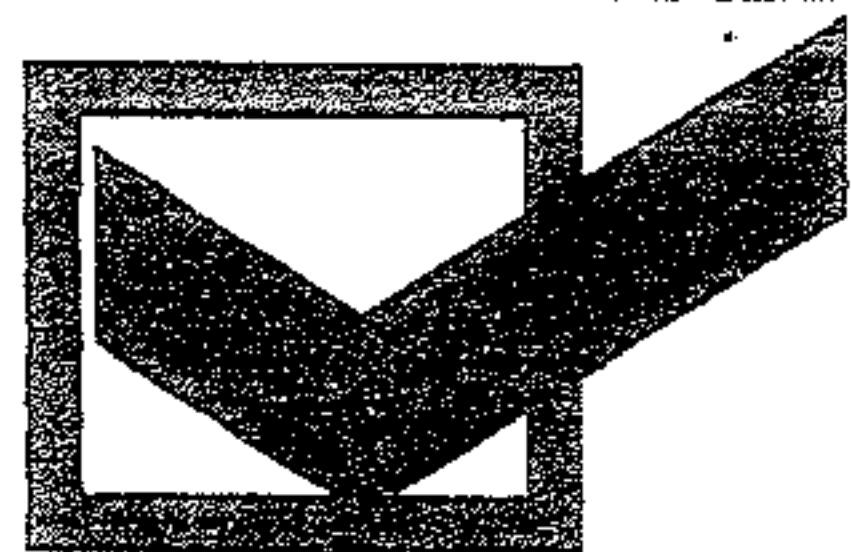

# APPROVED!

**NO CREDIT CHECKS**

Visit Us On The Web At:  
[martyautosales.net](http://martyautosales.net)

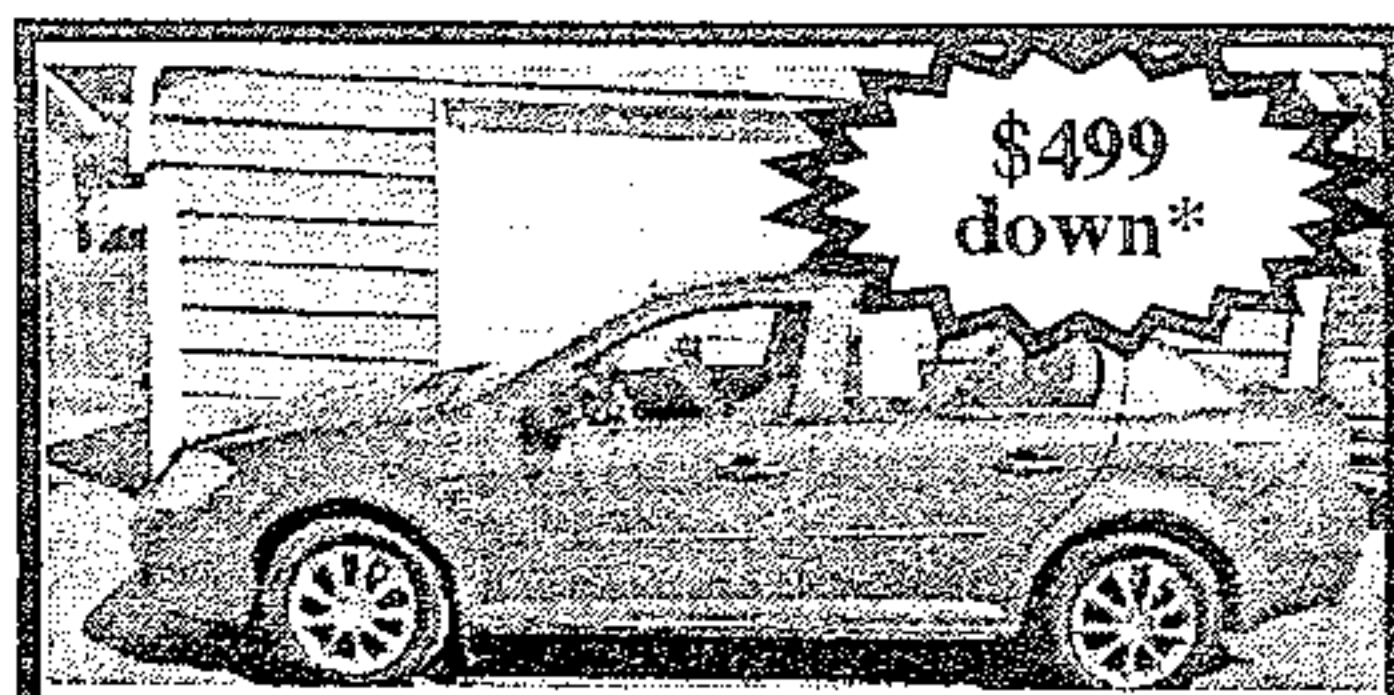

\$499 down\*

07 Cobalt, 5spd, gas saver, runs great Only \$499 down \*

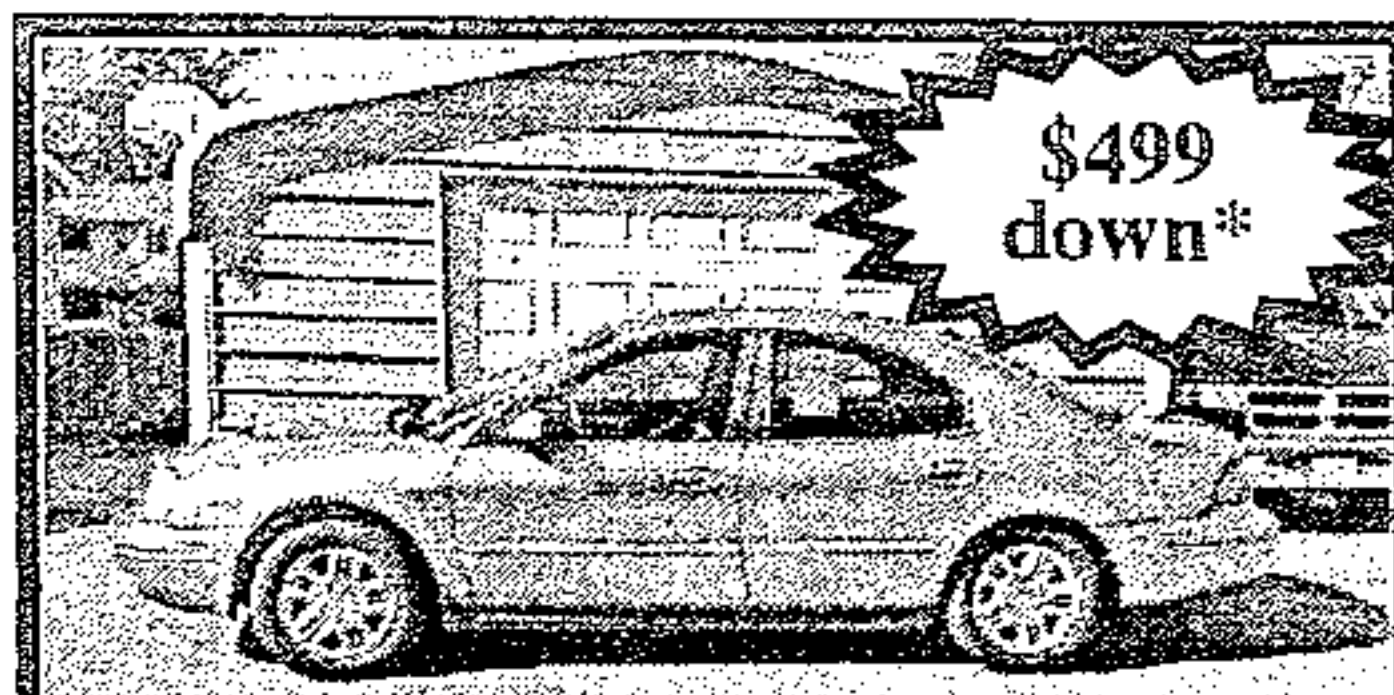

\$499 down\*

02 Sable, sunroof, loaded, Only \$499 down \*

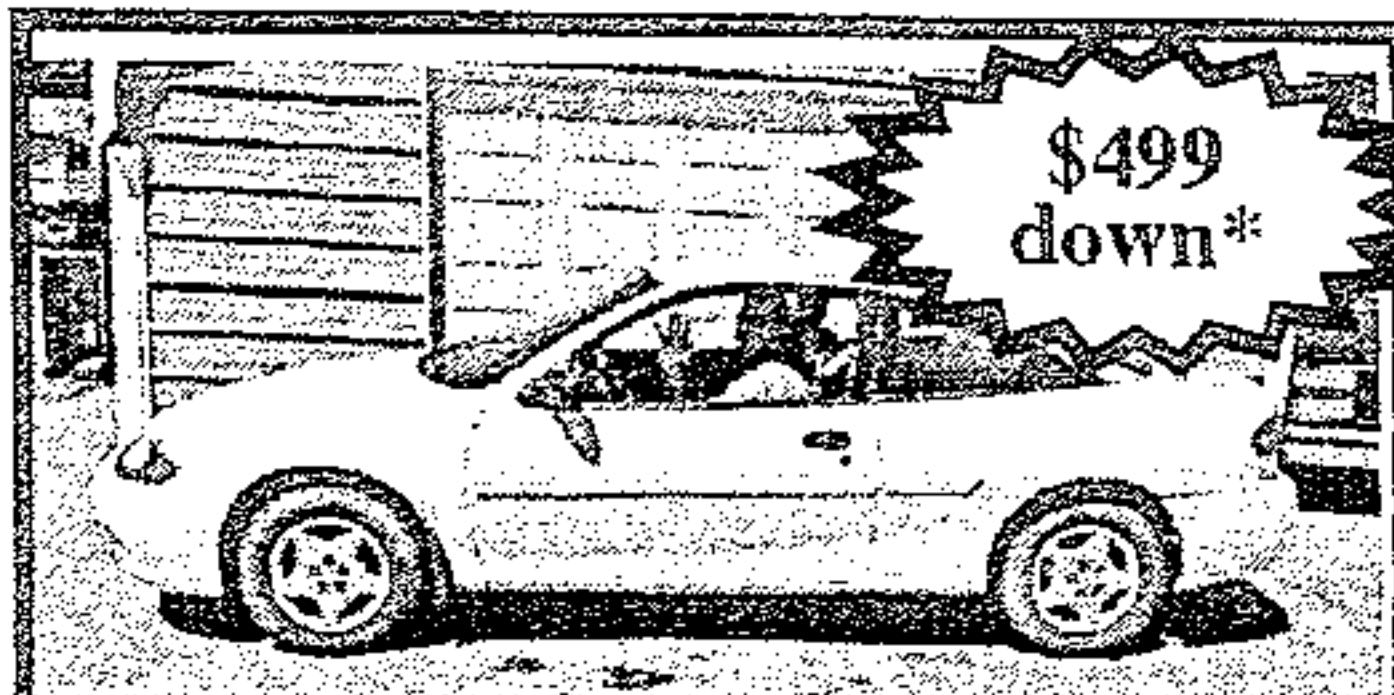

\$499 down\*

04 Cavalier, 2dr, Sporty, Only \$499 down \*

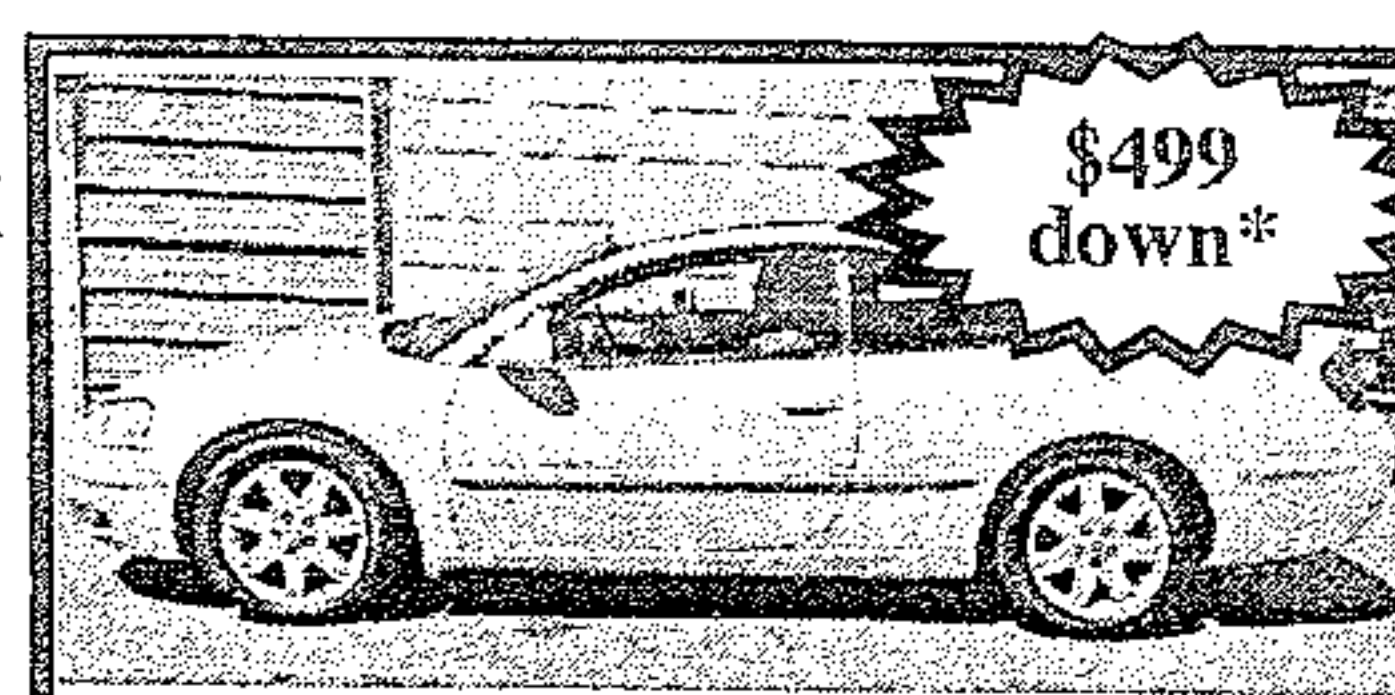

\$499 down\*

01 Sebring 2dr. sporty, Only \$499 down \*

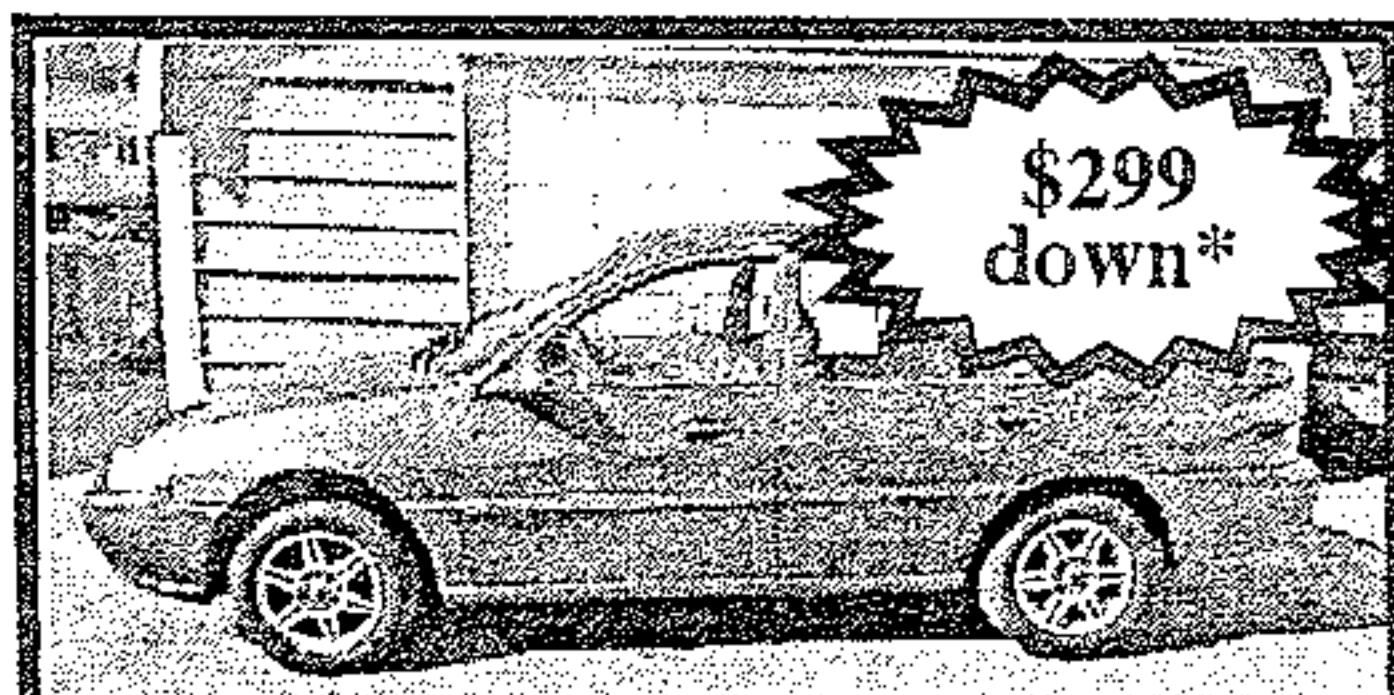

\$299 down\*

97 Escort, auto, Gas Saver, Only \$299 down \*

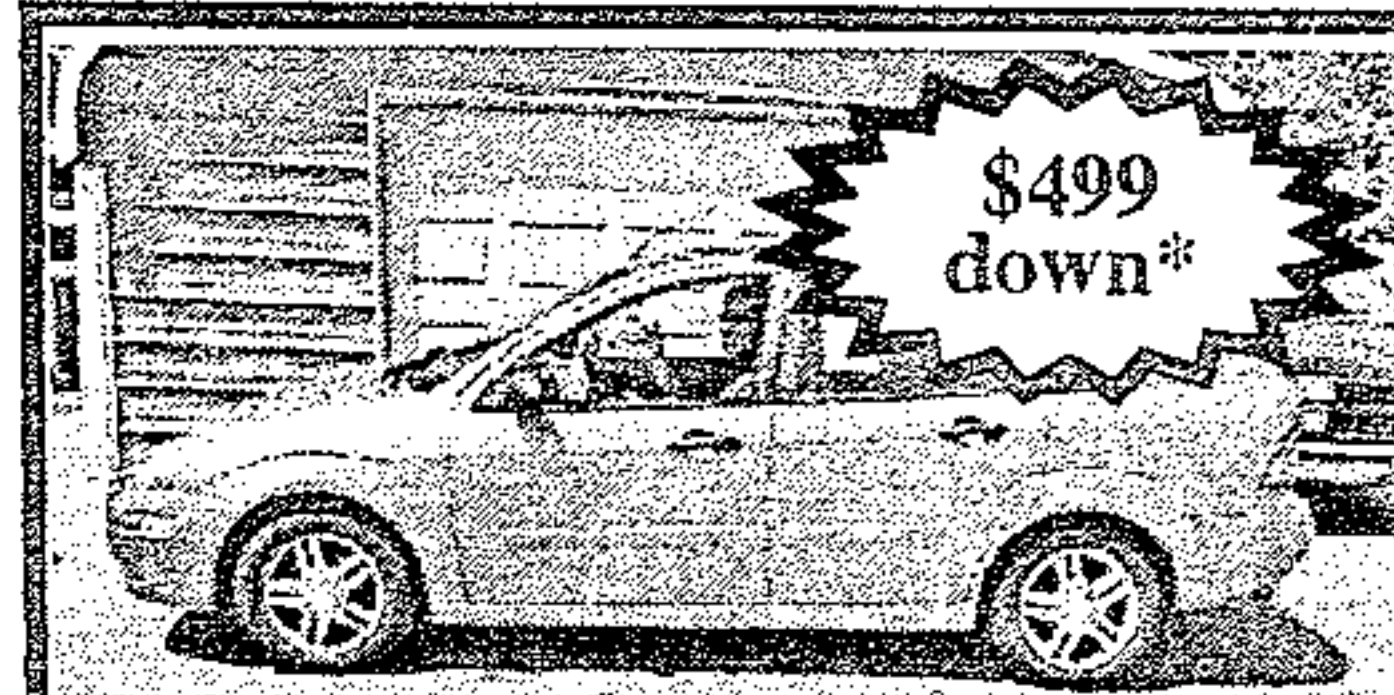

\$499 down\*

03 Focus 5 speed, Gas Saver, Only \$499 down \*

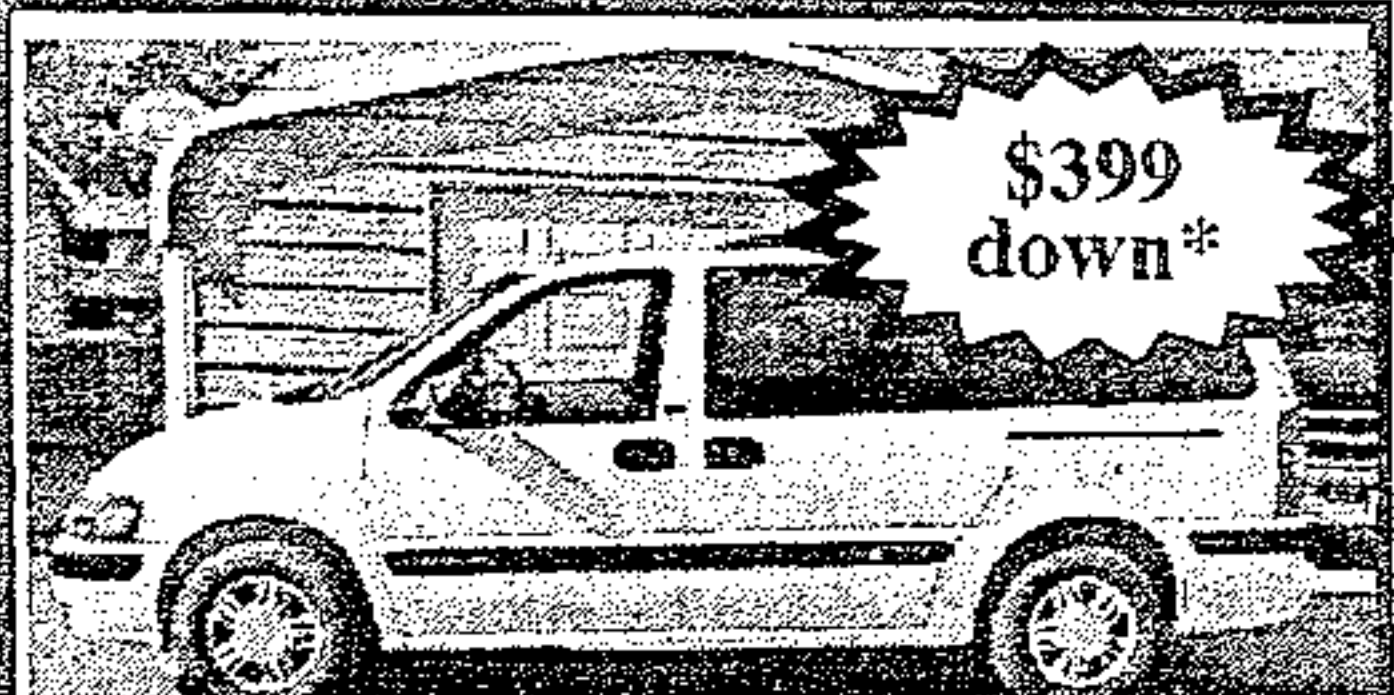

\$399 down\*

01 Venture, 7 passenger, Runs Great Only \$399 down \*

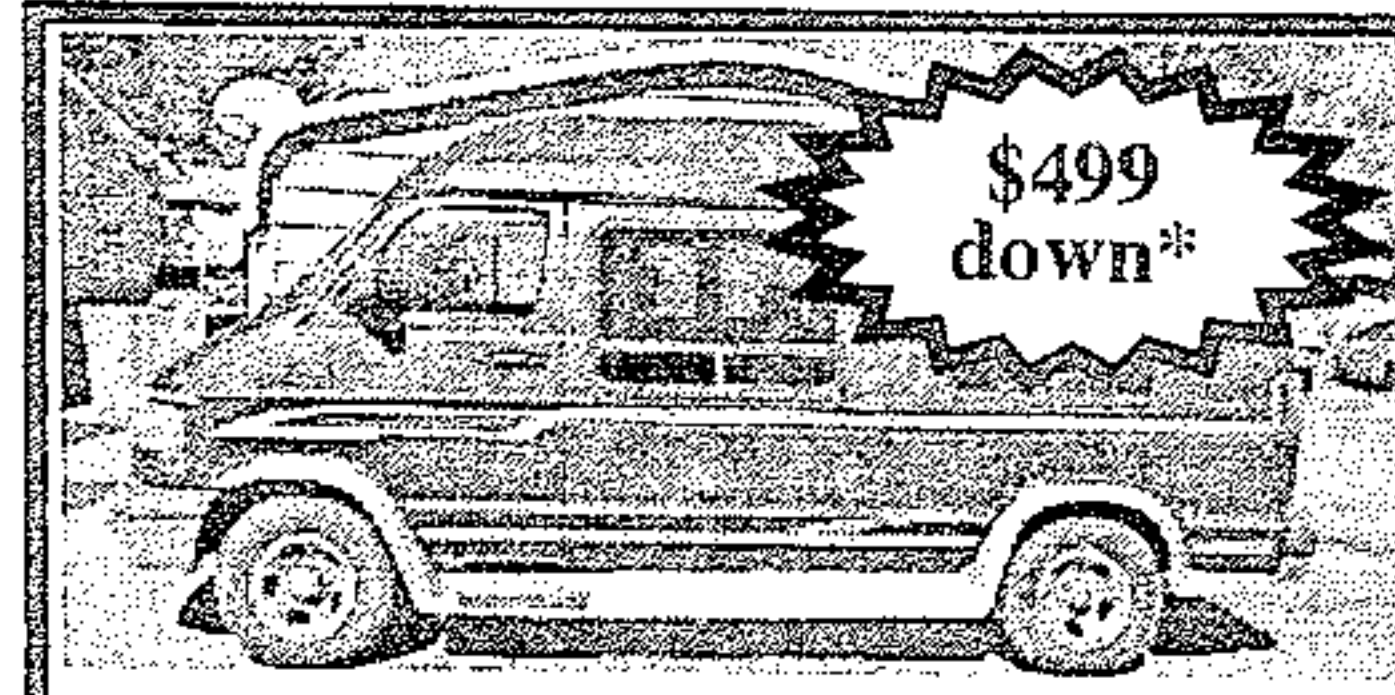

\$499 down\*

00 Ram, High Top Conversion Van, Loaded only \$499 down \*

**NO Credit Checks**

**Marty's Auto Sales**  
986-2222

Se Habla Espanol

**100% Approval\***

\*See Dealer for details. All down payments plus tax, tag, title and fees.

MARTY'S AUTO SALES • 986-2222 • MARTY'S AUTO SALES • 986-2222 • MARTY'S AUTO SALES • 986-2222 • MARTY'S AUTO SALES • 986-2222 • MARTY'S AUTO SALES • 986-2222

Posters ctd. from pg. 7

drawing process in this program is not really as fast as the drawing process in paper materials. On the other side of the working sheet of this given program, you can make effects such as the halftones that cannot be drawn with the use of pencils and papers.

Preparing layers after you have finished with the sketching process, it is now the time for you to convert all the images in your print materials into sepia tones before you work on the color elements. The process of converting the images into sepia tones is a very easy task that you can do on your own. After that, you can utilize the sliders to colorize the lines into yellow or some other colors that you want. In sepia, the sketch lines usually yield halftones that are subtle, which makes it easier for you to view the image but retain its

given form while in the coloring process.

Working with the lower layer always select a dominant dark type color that the secondary aspect can relate to without losing or decreasing the contrast in your print materials. It is a must for you to do this process so that you will not be lost in the details of all the given colors and images that is floating around your print materials.

Working with the top layer finally, the top layer is usually where you can work with the lines of the drawing in your poster printing by adjusting, refining and correcting them. This is also where you can work with the lighter colors to aid you smooth out uneven shapes. Once you are done coloring your poster design, the top layer is also, where you can get rid of the lines that will just negatively affect your print materials functionality.

**A Name You Already Know And Trust Just Got Even More Dependable**  
**DEPENDABLE AUTO SERVICE, LUBE AND TIRES**  
**is Now Offering**  
**Expert, Affordable Transmission Service**

All ASE Certified Technicians

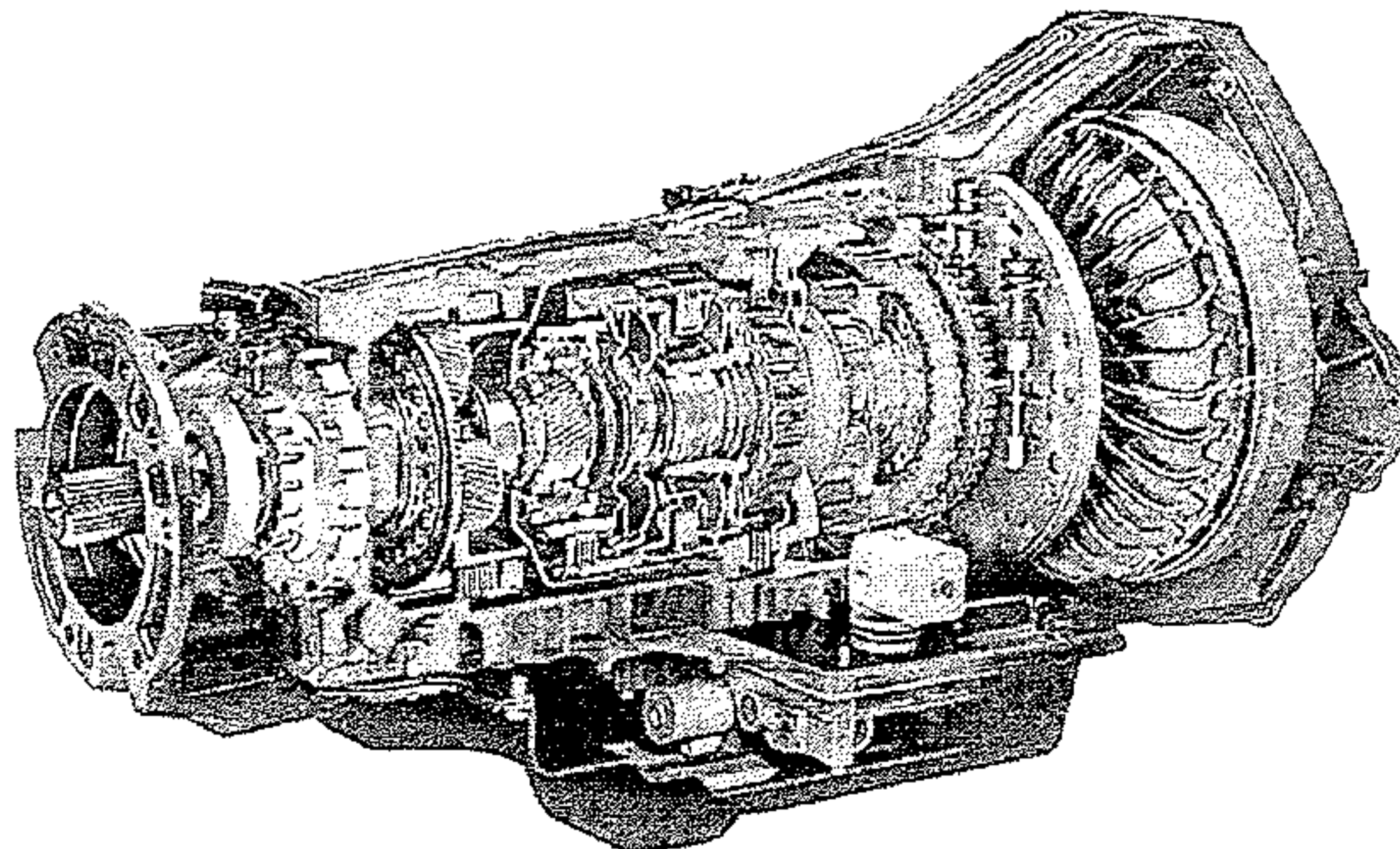

**We proudly welcome all New Customers and Former Advanced Transmission Customers with a 10% Discount and Any Transmission Service or Repair\***

**865-986-9359**

**865-986-5050**

**Bad Credit, No Credit OK!!! We Finance Everybody!!!**

**Low Down Payment!!!**

**Over 100 Cars, Trucks & Vans in Stock - Warranties On ALL Vehicles Sold!!!**

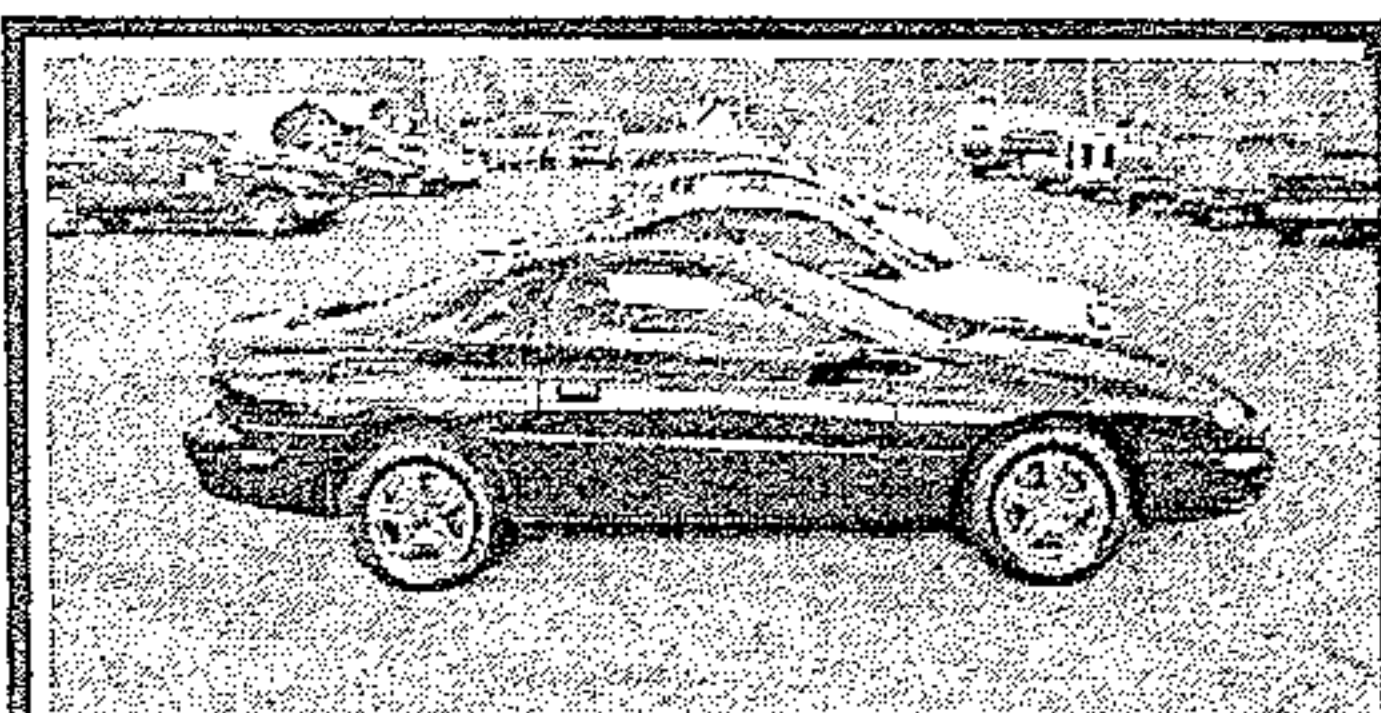

**2002 Chevy Camaro, 5 speed, low miles, NICE**

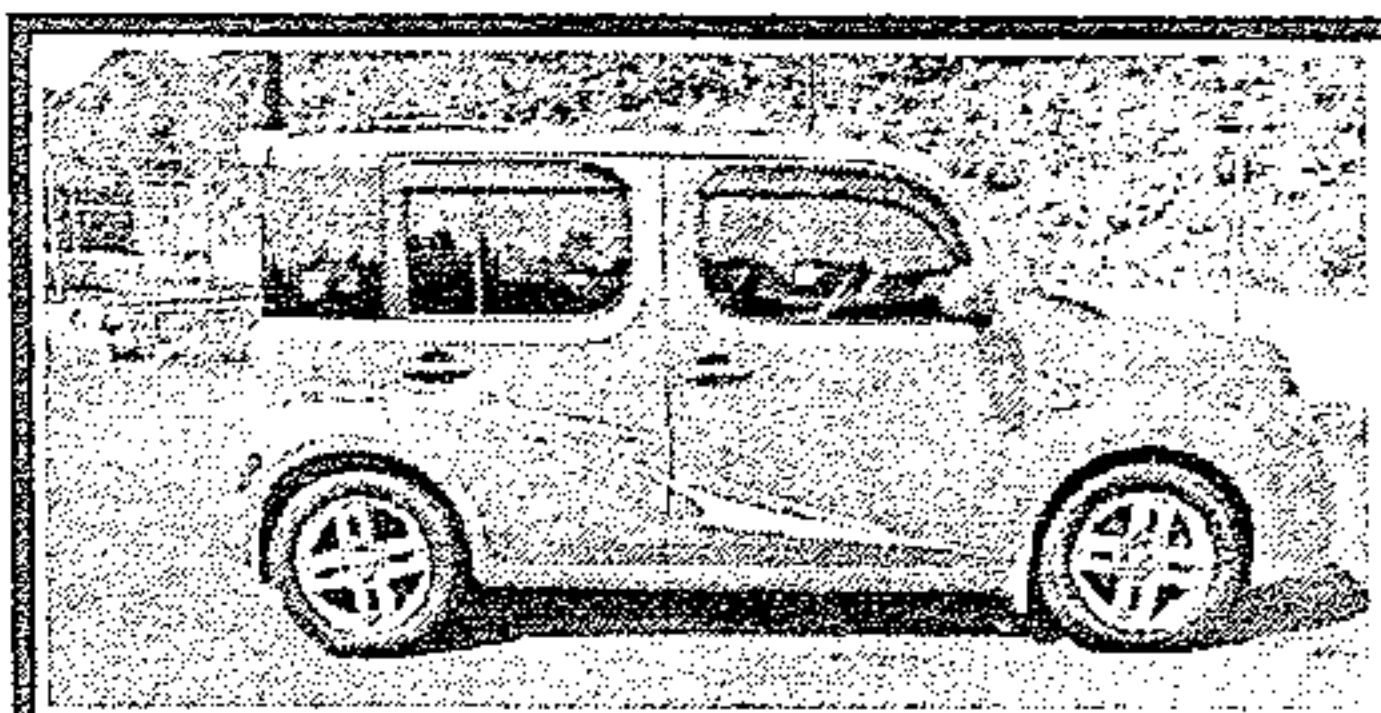

**2009 Nissan Cube, Great Gas Saver, Clean**



**2006 Rendevous, leather, 3rd row seat**

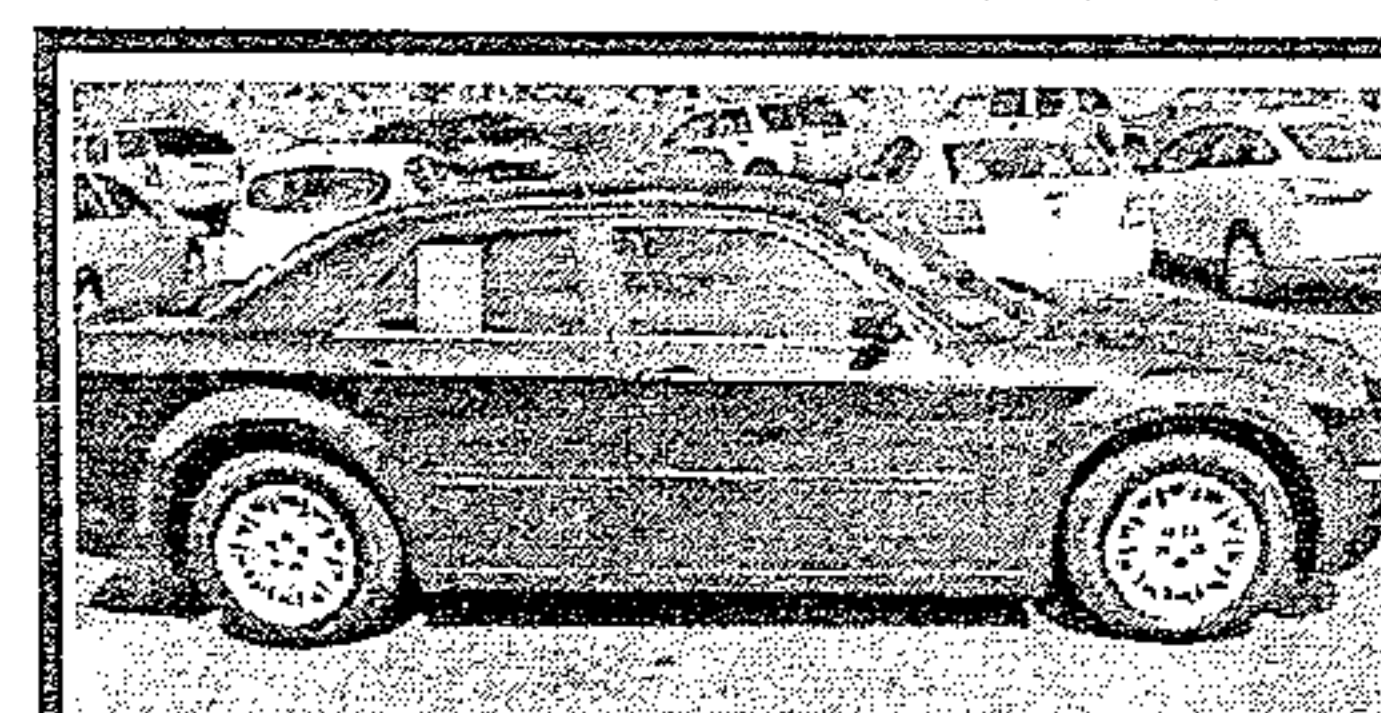

**2006 Chrysler 300, Loaded, Nice Ride**

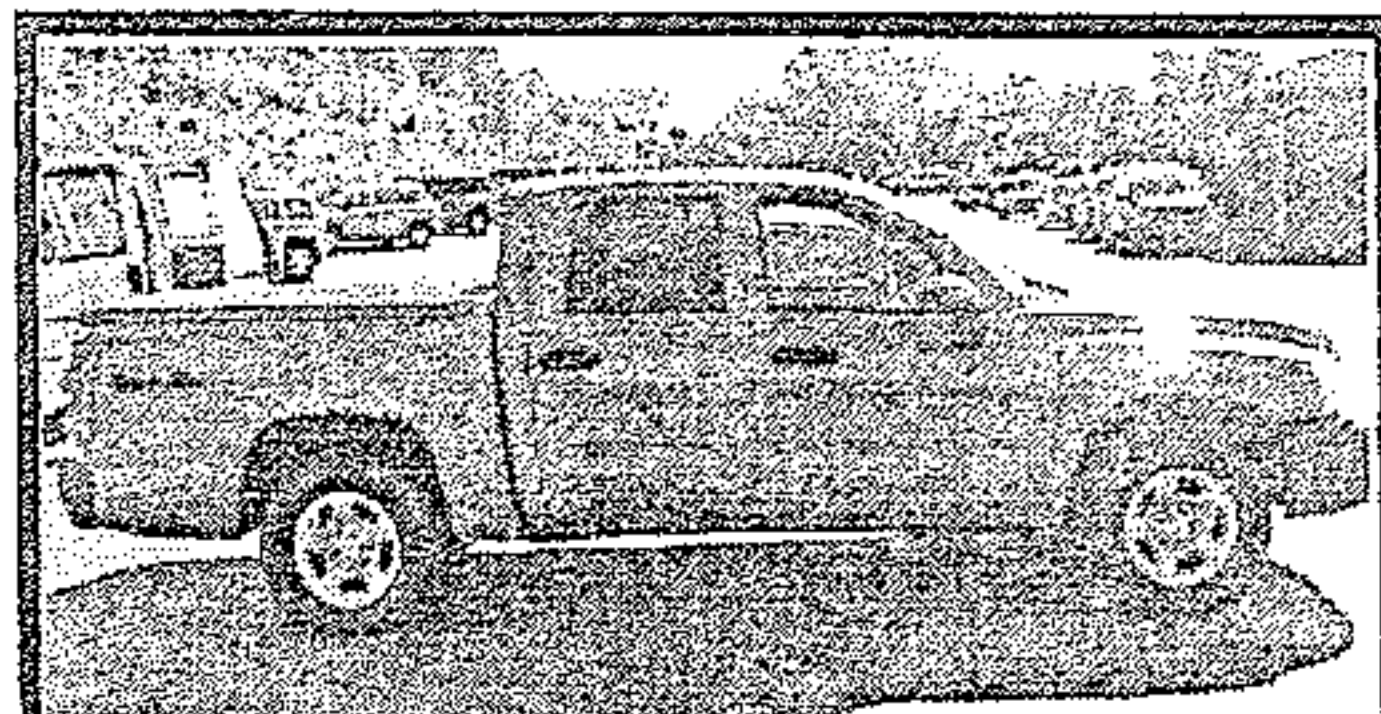

**2005 Dodge Dakota, 4dr, 4x4, Extra Clean, lots of room**

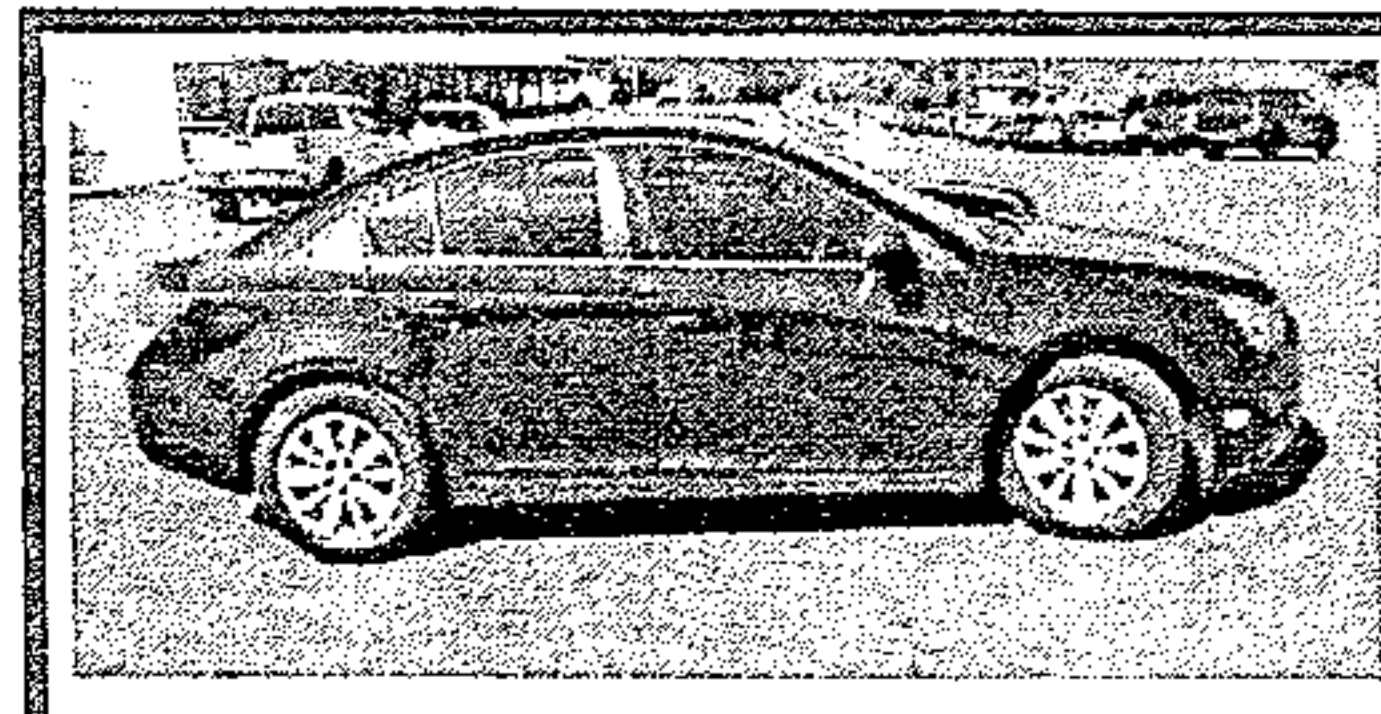

**2011 Chevrolet Cruze, LOADED!!!**



**2007 Suzuki Grand Vitara, V6, Nice!**

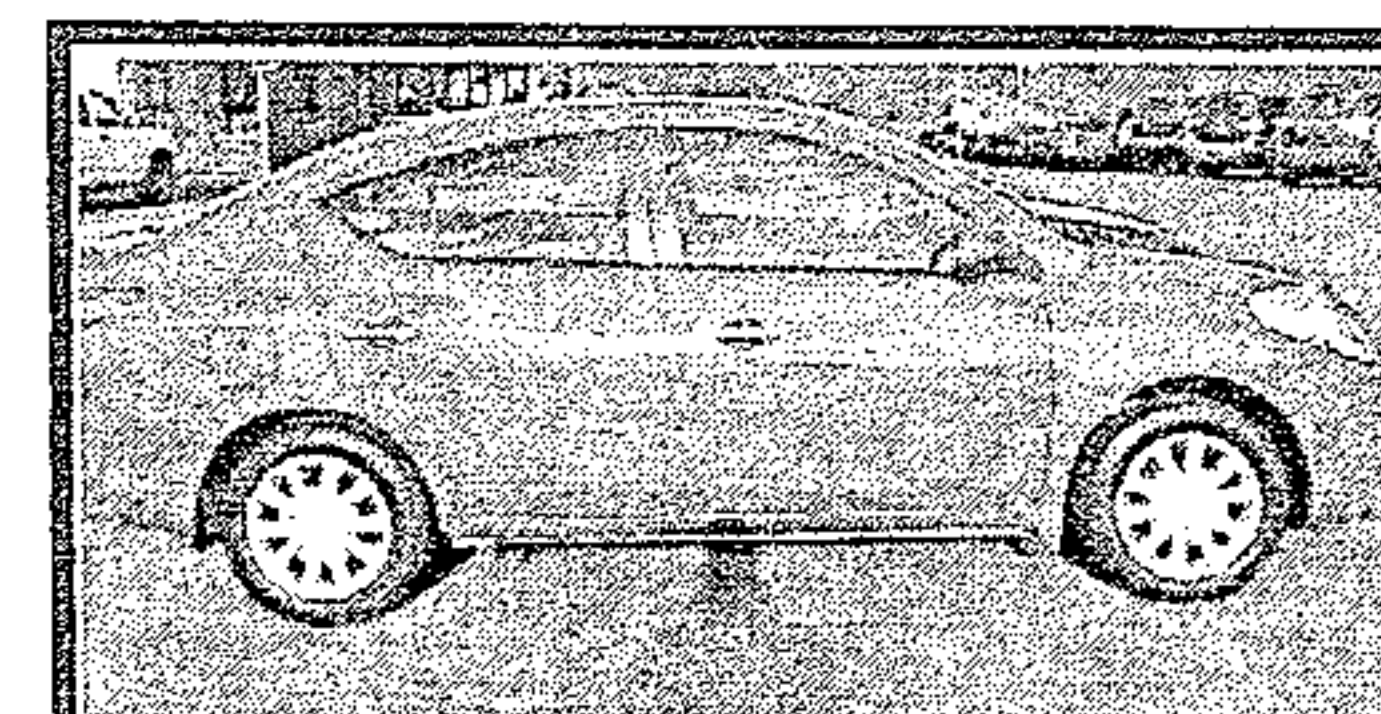

**2013 Nissan Versa, Like New! LOADED!!!**

**WALT WILLIAMS, INC.**

\*with approved credit

**3003 Highway 11 Lenoir City, TN 865-986-1111**