

The Daily Edition

50¢

Serving Loudon, Monroe and Surrounding Counties

Thursday, November 12, 2015

Thief nabbed in parking lot



Timothy Tindell

(see thief pg. 3)

Get Outta My Way!!!

Man charged after hitting vehicle and running



Andrew Hess

(see hit and run pg. 2)

4 more individuals sentenced in large A-PVP Conspiracy

Between Oct. 26 and Nov. 9, 2015, four more individuals involved in an extensive a-PVP (alpha-pyrrolidinopentiophenone) distribution conspiracy centered in northeast Tennessee, southwest Virginia and western North Carolina, were sentenced to serve time in federal prison by the Honorable Pamela L. Reeves, U.S. District Court Judge.

Melissa Carol Williams, 39, of Greeneville, Tenn., was sentenced to serve 115 months; Jason Kyle Dulworth, 35, of Greeneville, Tenn., was sentenced to serve 46 months; Jonathon Rae Watson, 32, of Concord, N.C., was sentenced to serve 80 months; and, Richard Carmen Ware, 72, of Hendersonville, N.C., was sentenced to serve 60 months.

(see sentenced pg. 5)

LCPD's Condee charges 2 following aggravated burglary



Shawn Scott



Jason Roberts

(see LCPD pg. 7)

Former Mount Juliet Police Sergeant Sentenced for Federal Program Fraud and Wire Fraud

Jason Ezell, 40, of Lebanon, Tenn., was sentenced today by Chief U.S. District Judge Kevin H. Sharp, to serve six months in prison and one year supervised release, announced David Rivera, U.S. Attorney for the Middle District of Tennessee. Ezell, a former sergeant with the Mount Juliet Police Department, pleaded guilty on July 23, 2015,

to federal program fraud and wire fraud. The Court also ordered him to pay more than \$13,000 in restitution.

Ezell was charged on July 10, 2015, with fraudulently preparing time cards and submitting fraudulent overtime logs, falsely claiming that he worked more than 500 hours of overtime in support of and assisting in federal Or-

(see FBI pg. 4)

Verse of the Day

Blessed is the man who perseveres under trial, because when he has stood the test, he will receive the crown of life that God has promised to those who love him. — James 1:12

Obituaries

see inside **Wazzup**
Thanks for all the great work you do Lenoir City Parks and Recreation Department, Keep up the Great Work. Looking forward to whats next!

Weather

Today: Showers in the morning, then clearing with ample sunshine in the afternoon. High 66F. Tonight: A mostly clear sky. Low 42F. Friday A mainly sunny sky. High 59F. Friday Night Clear. Low

near 35F.

Horoscopes

Scorpio 10/23-11/21

You can do nearly anything now if you put your mind to it and commit to relentlessly executing

(Continued on page 6)



hit and run

Andrew Hess, 24, Veal Heights Madisonville, was charged with Aggravated Assault x2, and Leaving the scene of an accident. Deputy JC Schultz LCSO, was dispatched to a hit and run road rage accident at I-75 SB at the 72 exit. The victim and her passenger were traveling SB at the 74 mm in the

fast lane, and a gold Toyota with bright blue headlights and a partial tag flashed its light for her to get over but she couldn't because she was blocked by semi trucks. The vehicle continued to follow victim flashing its light then struck the back of victim's vehicle. The vehicle was stopped by Monroe Co. Sheriff and the driver was identified as Andrew Hess,

who stated that he knew he should have stopped after hitting the vehicle. Cpl. M. Branam LCSO, transported Andrew to the Loudon Co Jail where he was charged. Deputy JC. Schultz LCSO, made the arrest.

Notice
 Vin 1G82557N87F202859
 General Motors Vehicle will be sold. If anyone has a lien on this vehicle contact: Homer's Body Shop, 10609 Beals Chapel Road, Lenoir City, 37772, 865-388-0372.

Notice: The Daily Edition does not knowingly accept fraudulent or misleading materials. The Daily Edition cannot guarantee the validity of offerings or statements contained herein. All liability for the contents of all advertising, and for any claims that may arise therefrom, is the responsibility of the advertiser or its agency. The Daily Edition reserves the right to reject, edit, or abbreviate any advertisement submitted. Advertising is accepted with the understanding that all liability for all copyright violations is the sole responsibility of the advertiser. Photographs, artwork and other copy submitted for publication is considered the sole property of the advertiser. The Daily Edition will make every effort but will not be liable for failure to publish and ad or for typographical and layout errors. All statements and information about highlights featured items, letters to the editor, herein are those solely given to the interviewer or writer and the Daily Edition assumes no responsibility of the accuracy or validity thereof. The Daily Edition will gladly reprint at no charge that part of an advertisement in which an error occurs provided a claim is made within 3 days of the first publication of the ad. Information contained in the Wazzup is received anonymously and the Daily Edition assumes no responsibility for information and reserves the right to edit or reject any and/or all submissions. The Daily Edition is a daily newspaper of general circulation in Loudon County defined under TCA 2-1-104(a)(13). The Daily Edition also serves Monroe, Knox, Anderson, Roane and Blount counties and serves 30,000 readers weekly. Send mail to PO Box 1240, Lenoir City TN 37771. 865-771-2249. email: dan1204us@yahoo.com
 The Daily Edition is Loudon County's premier public interest and paid advertising paper. The Daily Edition is produced and published daily Monday through Friday and is circulated throughout Loudon County and parts of Monroe and Knox Counties. Display advertising rates \$5.00 per column inch and quantity discounts available. Call for information on upcoming promotions and events.

HACIENDA Ayala's
Mexican Restaurant
 Market Dr. * Lenoir City (In Front of Food City)

Real Authentic Mexican Food at Affordable Prices

BEST MARGARITA

You've Tried The Rest
 Now Come Have The Best!!!

We Accept ALL Competitors Coupons Outside of Mexico City!

986-3553



Good Credit OK • Bad Credit OK • Bankruptcies OK • Repo OK



2010 Kia Soul Sporty, 4 cyl, Auto, PW, PL, A/C, Great On Gas, Like New



2010 Ford Escape Limited Leather, Alloy Wheels, Heat, A/C, Luggage Rack, 79K,



2007 Dodge Ram 1500 Quad Cab, Thunder Road PKG, 20 in. Wheels, Low Miles, Hemi



2008 Ford Explorer 84k, 3rd Row Seating, Luggage Rack, Tow Pkg, PW, PL



2011 Ford Ranger Low Miles, Tow Pkg, New Tires, A/C, Heat, Bed Liner.



2011 Dodge Grand Caravan DVD, Stow & Go, Loaded, Remote Doors, Rear A/C

DEPENDABLE MOTORS 986-9343
 803 E. Broadway • Lenoir City

Serving Loudon County for 20 Years

* WAC. See Dealer for details

Visit our website at: www.dependablemotorslc.com

thief

Timothy Tindell, 41, Outer Drive Oak Ridge, was charged with Theft of Property. Officer Brandon Johnson LCPD, was dispatched to the Walmart on regards to a shoplifter. Upon arrival Officer made contact with a subject matching the description of the shoplifter in the parking lot. Officer identified the subject as Timothy Tindell. While Officer search Timothy he located 2 knives, 2 flashlights, and Pet Armor that had been opened and taken out of the packing. Timothy was placed under arrest. Officer Brandon Johnson LCPD, made the arrest.

Obituaries

Christine (Chris) Haworth -age 45 of Lenoir City, passed away suddenly Thursday, November 5, 2015. She was an employee of Aubrey's Restaurant in Farragut. Chris was a loving and devoted mother to her son, Dylan Haworth. The family will receive friends from 2 - 3 p.m. Wednesday November 11 at Click Funeral Home in Lenoir City. A memorial service will follow at 3 p.m. in the Click Funeral Home Chapel. A private interment will

be held. Click Funeral Home in Lenoir City is in charge of arrangements.

Roy C. Riddle - age 78 of the Alwick Community, passed away Friday, November 5, 2015. Mr. Riddle was an electrician and retired from the Blount County Schools, Maintenance department. A veteran serving in the US Navy. He was preceded in death by his precious wife of 55 years, Katherine (Worthy) Riddle, in July of this year; his parents, John Daniel and Ruby Merritt (Thompson) Riddle; brothers and sisters in-law, Joseph and Jan

Riddle, Bill and Jean Cavett; sister and brother in-law, Blanche and Donald Watkins, and infant sister, Katherine. He is survived by his sister and brother in-law, Margaret and Harold Heiser, Pennsylvania; brother and sister in-law, Glenn and Katherine Riddle, Maryville; several nieces, nephews and friends. Graveside services will be held 2:00 PM Wednesday, November 11, 2015 in the

Loudon County Memorial Gardens, 6505 Hwy 11 West, Lenoir City. McGill-Karnes Funeral Home, Loudon.

Joanne Aldene (Al) Kinser - age 84 of Lenoir City went to be with her Lord on Wednesday, November 11, 2015. Al was a member of Calvary Baptist Church for 62 years. She worked in Quality Control for Genesco. Al was faithful to take care of

(see obits ctd. pg. 5)

The Daily Edition
serving Loudon and surrounding counties since 1986

For Sale: oak Wood Mulch

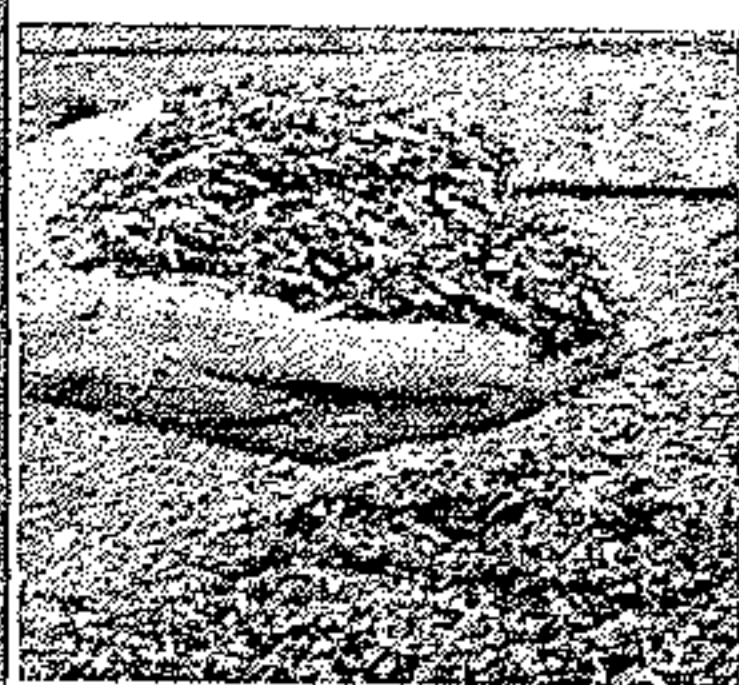

Mushroom Compost Topsoil.



Call Steve Spoon
986-4282

West End Storage & Warehouses
502 Ward Avenue • Loudon
Call 865-458-4774 or 865-679-5555



C&J Towing and Recovery

LOWEST TOWING RATES AROUND!!!

Have you been overcharged for any type of towing service in the Lenoir City area? If you have a breakdown or accident please OWNER REQUEST C&J Towing with the officer. Also please call your Sheriff and ask him to place C&J Towing on the "Rotation List*" and help other motorists save as much as you did! We at C&J are locally owned and operated, State approved, licensed, bonded and insured. Call and let us know if your denied service or how we can be of assistance.

*note: the "Rotation List" is a list of wrecker services that provide service for wrecks, DUI's, breakdowns, etc. and are on an on-call basis for service. This list is approved by the Sheriff.

Cliff Teeters • Owner
865-809-1661

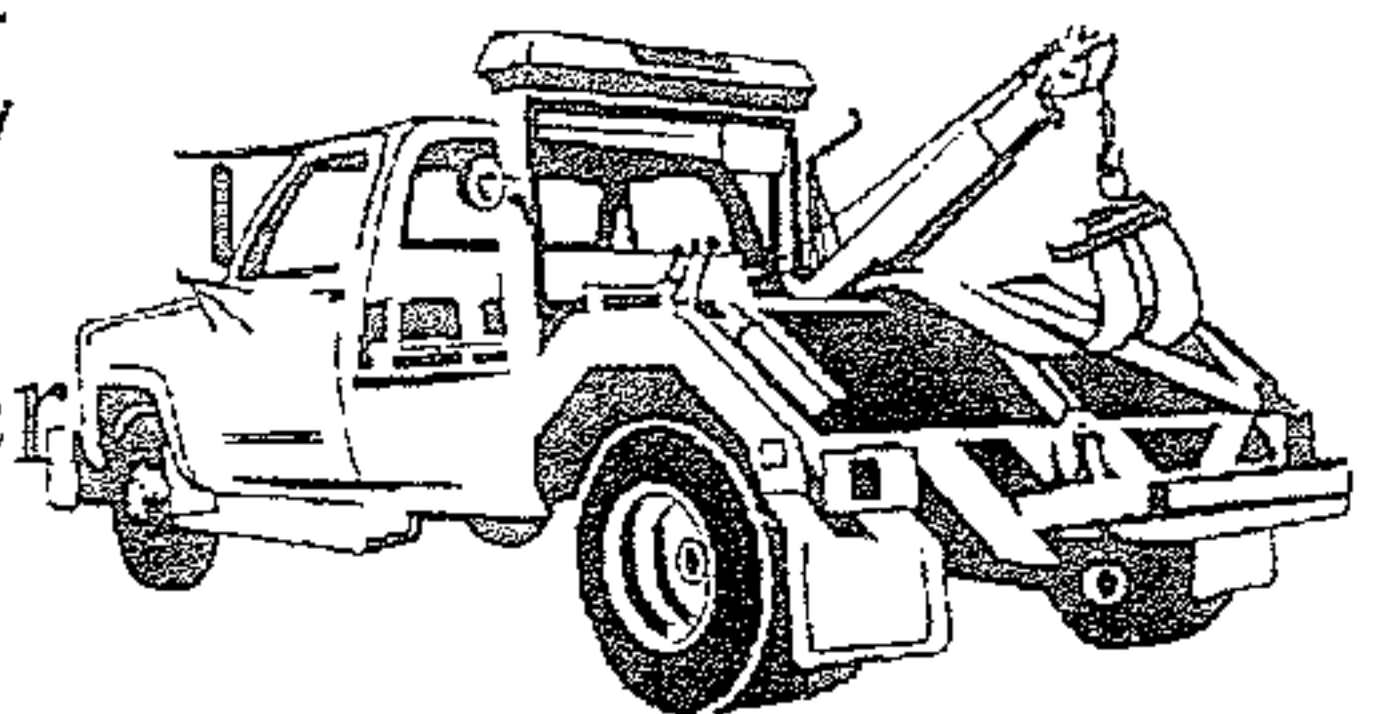

BIMBO'S
Deli Open 24 Hours
865-986-9643 Call Ins Welcome
Specials
Lg. Gold Sub, bag of chips and 16 oz. fountain drink only \$6.29
Footlong Corn Dog \$2.59

FBI

ganized Crime Drug Enforcement Task Force (OCDETF) investigations during the period of January 2013 through April 2015. During that time, Ezell was a sergeant with the Mount Juliet Police Department and supervised the Crime Suppression Unit.

In sentencing Ezell, Chief Judge Sharp noted that "there was an abuse of trust of the position the people placed him in to be a good steward of the public's money." Judge Sharp also said the sentence "needs to reflect the seriousness of the offense and send a message that you can't dip into the public till and receive probation if you're caught."

This case was investigated by the Ten-

nessee Bureau of Investigation; the FBI; the District Attorney's Office for the 19th Judicial District; and the DOJ Office of Inspector General. Assistant U.S. Attorney Thomas J. Jaworski is prosecuting the case.

Loudon County Sheriff's Office Toys for Tots 2015

Thanks to the gener-

osity year after year of the Loudon County residents, churches, businesses and industries, the Loudon County Sheriff's Office is once again able to offer the Toys for Tots program. We are beginning our 31st year of providing toys to the needy children of Loudon County, and thanks to generous contributions of time,

money and gifts, we are able to make Christmas a more joyful time for more and more children. In 2014, approximately 500 children were helped by the Loudon County Sheriff's Department Toys for Tots program through their partners. Even with the difficult economic times we are experiencing, we

hope that the people of Loudon County will be there once again to help.

Names will be available beginning in mid-October through business and churches. If you are considering helping a child this Christmas, please be assured that applicants are thoroughly checked to (see T4T ctd. pg. 5)

SARCO Enterprises Inc. Offers Complete Home and Commercial Remolding and Repairs

Our Team members have a combined total of over 40 years experience in all areas of home construction, facilities maintenance and commercial construction. Roofing, Electrical, Bath and Kitchen Renovations, we do it all with just one call. We are fully insured and our work is guaranteed.

Call us today for a free no obligation quote for your next project.
865-809-9492.

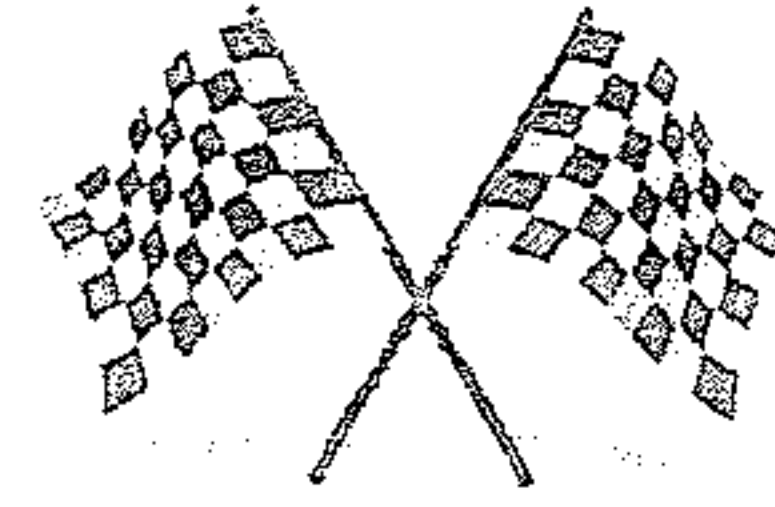

SOUTHERN AUTO DETAILING

414 WEST BROADWAY

LENOIR CITY, TN 37771

865-986-0724

Starting at \$34.95

Present this ad for \$5.00 off

BUDGET
Transmissions

Why Buy From Budget?

Free Towing From Lenoir City or Loudon County

20 Years of BBB Zero Customer Complaints Award Member

A+ Plus Rated

Huge Transmission Inventory
Best Technicians Period!!!

Call (865) 584-4391 Today!

302 S. Northshore Drive Knoxville

(865) 584-4391

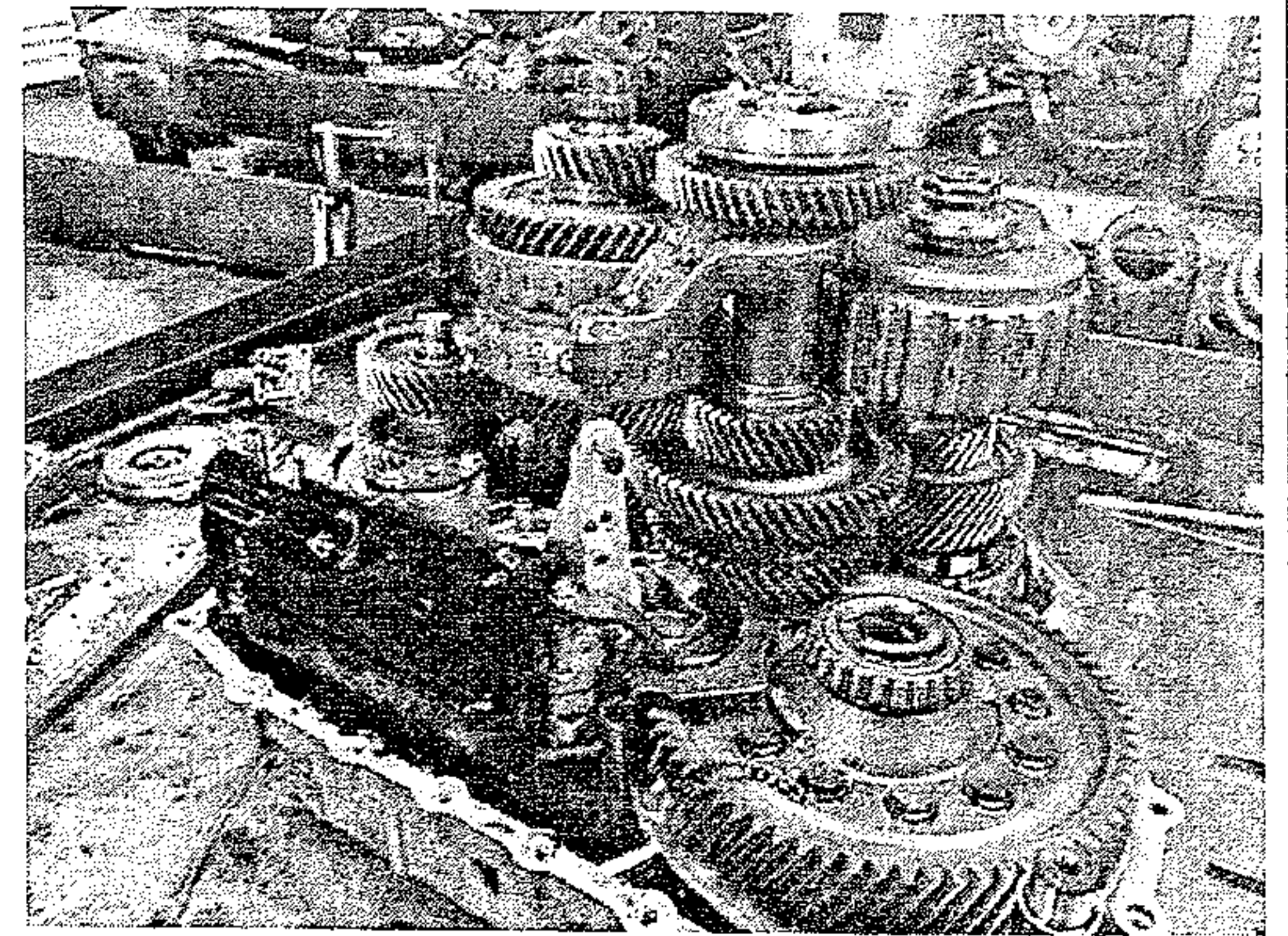

State-of-the-Art Diagnostics

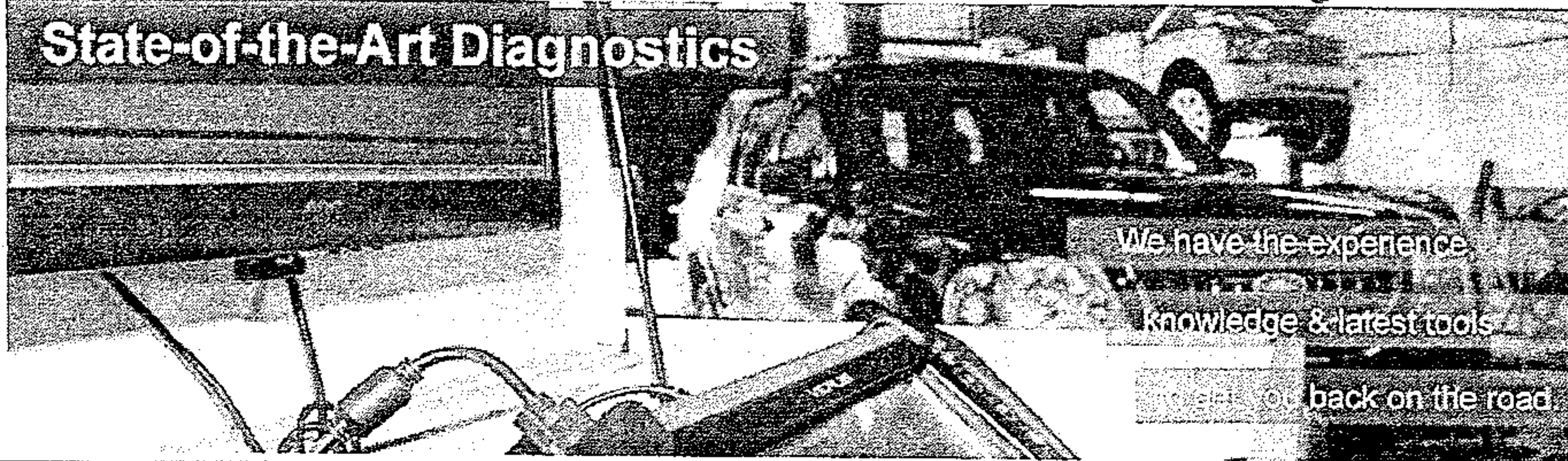

We have the experience

Knowledge & latest tools

to get you back on the road.

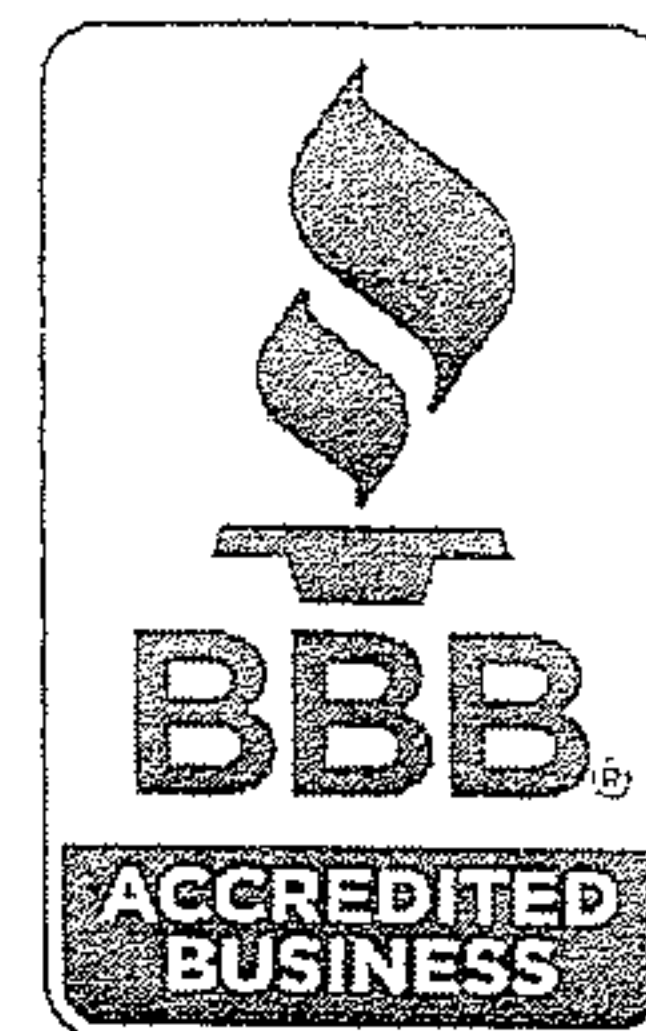

budget-transmissions.com



Approved Auto Repair



sentenced

Twelve others who were previously sentenced in this conspiracy received prison sentences ranging from 110 to 235 months.

According to the plea agreements on file with the U.S. District Court Clerk, the combined aggregate total of a-PVP stipulated to by Williams, Dulworth, Watson and Ware was approximately 19,275 grams.

A-PVP is a synthetic

drug, primarily ordered from China, which is commonly referred to on the street as "gravel" or "flakka." Common effects on users include: extreme paranoia; hallucinations; elevated blood pressure; extremely high body temperature; excited delirium; staying awake for days; hostility and having exceptional strength without apparent fatigue. These characteristics of the drug make it very dangerous for

both the user and law enforcement responding to people who are using the drug. Users of a-PVP have referred to the substance as "meth on steroids."

Law enforcement agencies participating in this investigation included the Drug Enforcement Administration, Bureau of Alcohol, Tobacco and Firearms, Homeland Security Investigations, Sullivan County Sheriff's Office, Kingsport Police

Department, Hawkins County Sheriff's Department, Johnson City Police Department, Greeneville, Tennessee Police Department, Hendersonville, North Carolina Police Department, and the Scott County, Virginia Sheriff's Office, all of which provided invaluable assistance during the course of the investigation. Assistant U.S. Attorney Wayne Taylor represented the United States.

Obits ctd. from pg. 3

her grandmother, Stella Ryan Nichols for many years. She was preceded in death by her parents, Floyd Kinser and Gladys Nichols Stout; half brother, Ron Stout; grandparents, Bill Nichols and Stella Ryan Nichols, Martin (M. L.) and Julia Kinser; several aunts and cousins. Survived by her twin sister, Ernestine (Teeny) Young and husband, Johnny Young; aunt, Margaret Wells (Ralph); many cousins; special friends, Janice Reynolds, Ken and Jane Ezell. Friends may call at their convenience at Click Funeral Home in Lenoir City. Family and friends will gather at 1 p.m. Friday, November 13th at Click Funeral Home and proceed to the Lenoir City Cemetery for graveside services at 1:30 p.m. with Rev. Jim Best officiating. In lieu of flowers, memorials may be made to East Tennessee Children's Hospital, 2018 West Clinch Avenue, Knoxville, TN 37916. Click Funeral Home, 109 Walnut Street, Lenoir City is in charge of arrangements.

FBI ctd.. from pg. 4

make sure they require this assistance. Names are also compared with the school systems to make sure no one is receiving duplicate assistance.

If your business or church would be willing to take names please call Debbie Hines, Toys for Tots Coordinator at 986-4823.

PURDY'S AUTO PARTS AND SALVAGE
WE BUY SCRAP IRON • COPPER • BRASS • ALUMINUM

\$ **Paying Top \$\$\$**
Call For Latest Prices

You Name It, We Buy It!

Radiators, Wheels, Batteries, Appliances, Farm Equipment

Copper
Paying Top \$\$\$
Call For Latest Prices

Complete Cars
per 100 lbs.

Scrap Metal
Paying Top \$\$\$
Call For Latest Prices
per 100 lb

We Buy Batteries

Aluminum Cans
Paying Top \$\$\$
Call For Latest Prices

You Call We Haul!
423-519-5402

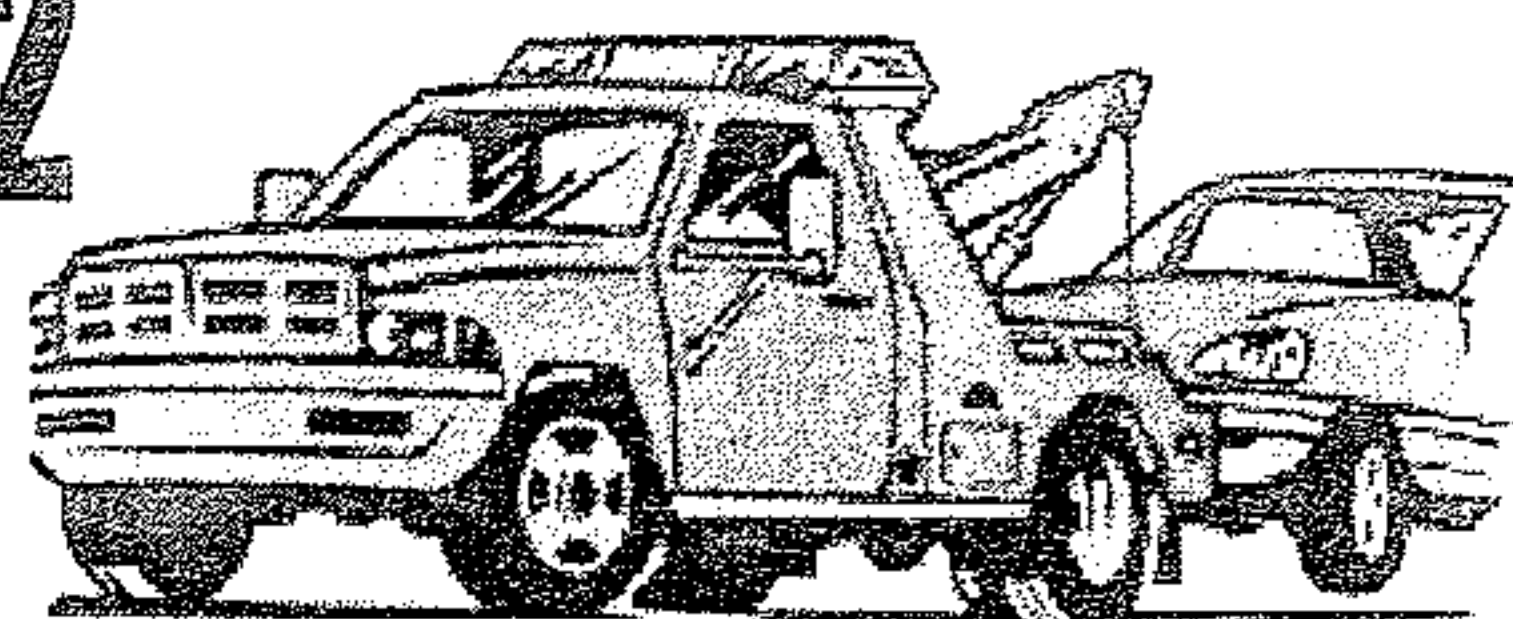

Now Selling
Aftermarket
Body Parts at
Discount Prices

Prices subject to change with the market.

423 337-3977
149 County Road 323 Sweetwater

Prices subject to change with the market.

LCPD

Jason Roberts, 28, Summer Street Loudon, was charged with Vandalism, and Aggravated Burglary.

Shawn Scott, 32, Cemetery Road Loudon, was charged with Aggravated Burglary, and Vandalism.

Capt. Kevin Condee LCPD, investigated a burglary at Jim Hartsook Drive. After investigation it was learned that Jason Roberts and co-defendant Shawn Scott did attempt to enter victim apt. the purpose of committing a theft. Scott assisted and otherwise facilitated this crime by conspiring with Roberts and then assisting Roberts into

the attic of an adjacent apt to the victim. From there Roberts forced through a firewall and attempted to enter the victim apt. by breaking the sheetrock wall.

It did not appear that Roberts was successful in gaining entry but did cause significant damage. Both parties were charged. Capt. Kevin Condee LCPD, made the arrest.

Holiday Loans: Worth enjoying a vacation

by: James Roy

Every person has a desire to spend some of his or her free time with his or her family. Even we have left the nomadic life long after the development of abodes, but we feel like relaxing or going for a small holiday once in a while. We dream of spending vacations at an

exotic place. But spending time with your family enjoying holidays could be expensive. You would certainly require a great amount of money to enjoy the dream as this cannot be fulfilled out of a fixed salary scale that is where some holiday loans come into picture! These loans are very economical.

These are small but helpful cash advances which are offered to the people who want to spend their free time or vacations. The loan amount is not fixed as it depends on the credit position of the borrower. This loan amount is usually granted for a short span of few weeks only. These loans are offered in both secured as well as unsecured way. In the secured ones, you have to

vow your assets with the lending institutions while in another case, there is no such requirement, but it has a demerit. Loans without collateral are offered at higher rate of interest and for a shorter span of time.

You may also apply for such over the Internet. It is the easiest and fastest way to get the money approved. Just do a small research and visit any lending institutions r banking websites and apply for a holiday loan via filling an online form. It takes a while to get loan approved which may take one day

to a week. As a borrower one should always do a research on interest rates and facilities provided. These loans are easy to get and economical too. You must be above 18 years of age while applying for this lone and you should have a continuous income flow as it is a mandate. Refreshment is equally important as important is your work. Enjoy the vacations but do not forget that timely payment of loans will not only add to your credit rating but it will make sure that you do not end up paying a huge amount!

Is Your Washer Broken?
Call Me I Only Charge \$100 Period!!!
Call Allen 865-617-7113

LOOK! \$75 Weekly Payments LOOK!

MARTY'S AUTO SALES • 986-2222 • MARTY'S AUTO SALES • 986-2222 • MARTY'S AUTO SALES • 986-2222 • MARTY'S AUTO SALES • 986-2222 • MARTY'S AUTO SALES • 986-2222 • MARTY'S AUTO SALES • 986-2222

- Bad Credit
- Divorce
- Fixed Income
- Repos
- Bankruptcy
- No Credit

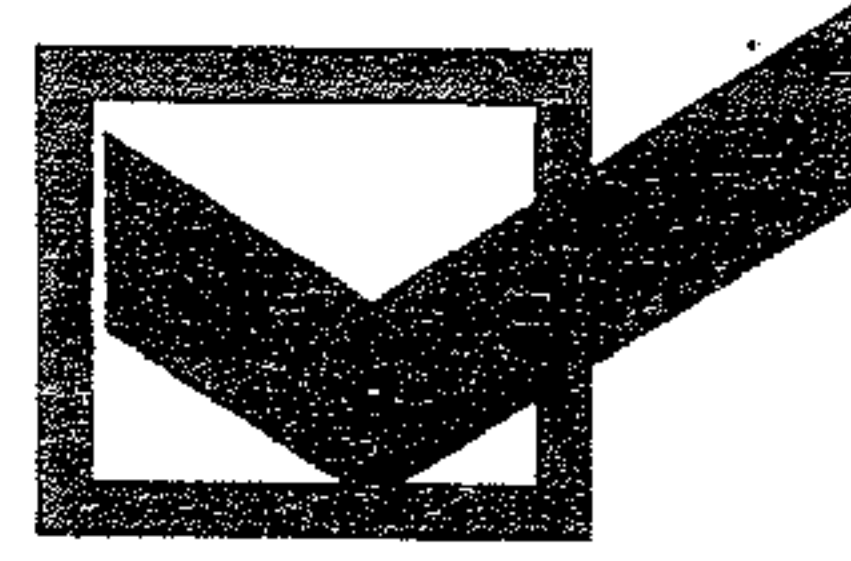

APPROVED!

Visit Us On The Web At:
martysautosales.net

NO CREDIT CHECKS



07 Cobalt, 5spd, gas saver, runs great Only \$499 down*



02 Sable, sunroof, loaded, Only \$499 down*



04 Cavalier, 2dr, Sporty, Only \$499 down*

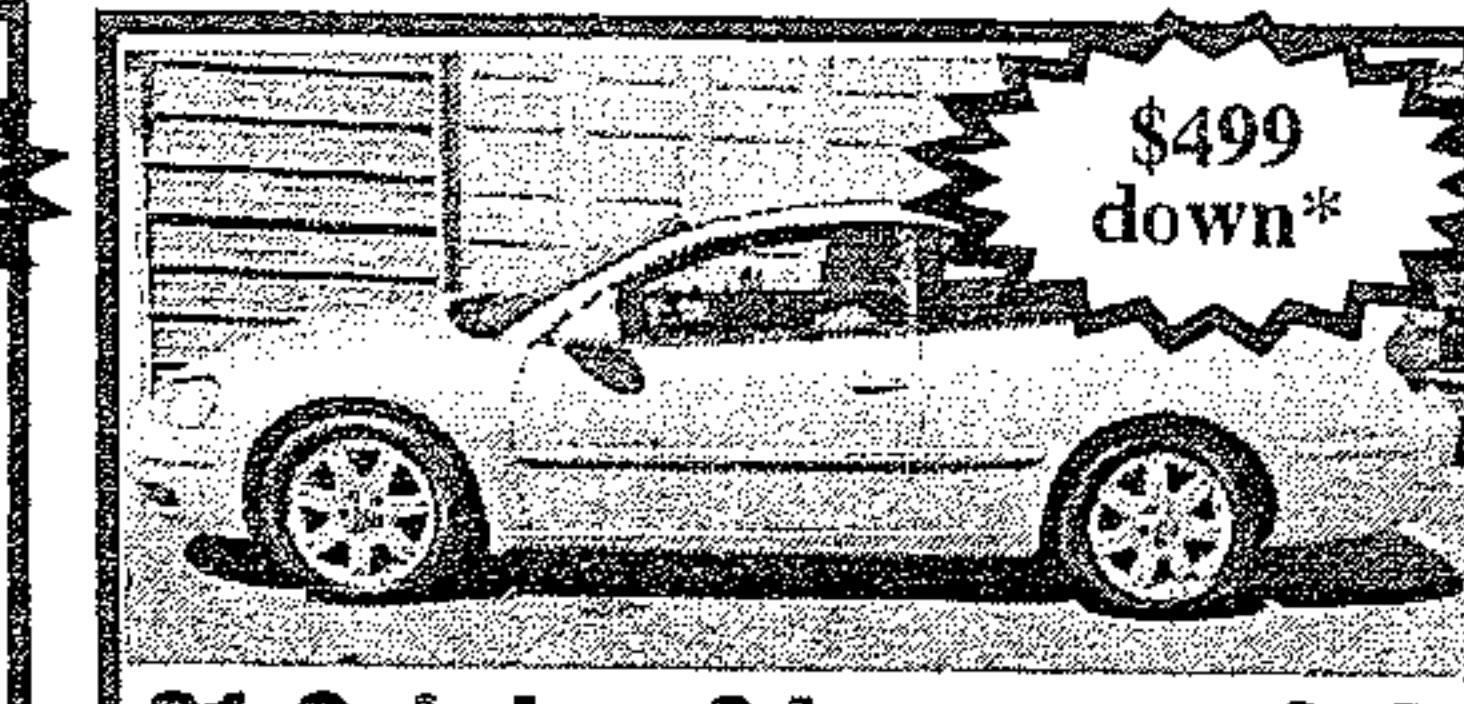

01 Sebring 2dr. sporty, Only \$499 down*



97 Escort, auto, Gas Saver, Only \$299 down*



03 Focus 5 speed, Gas Saver, Only \$499 down*

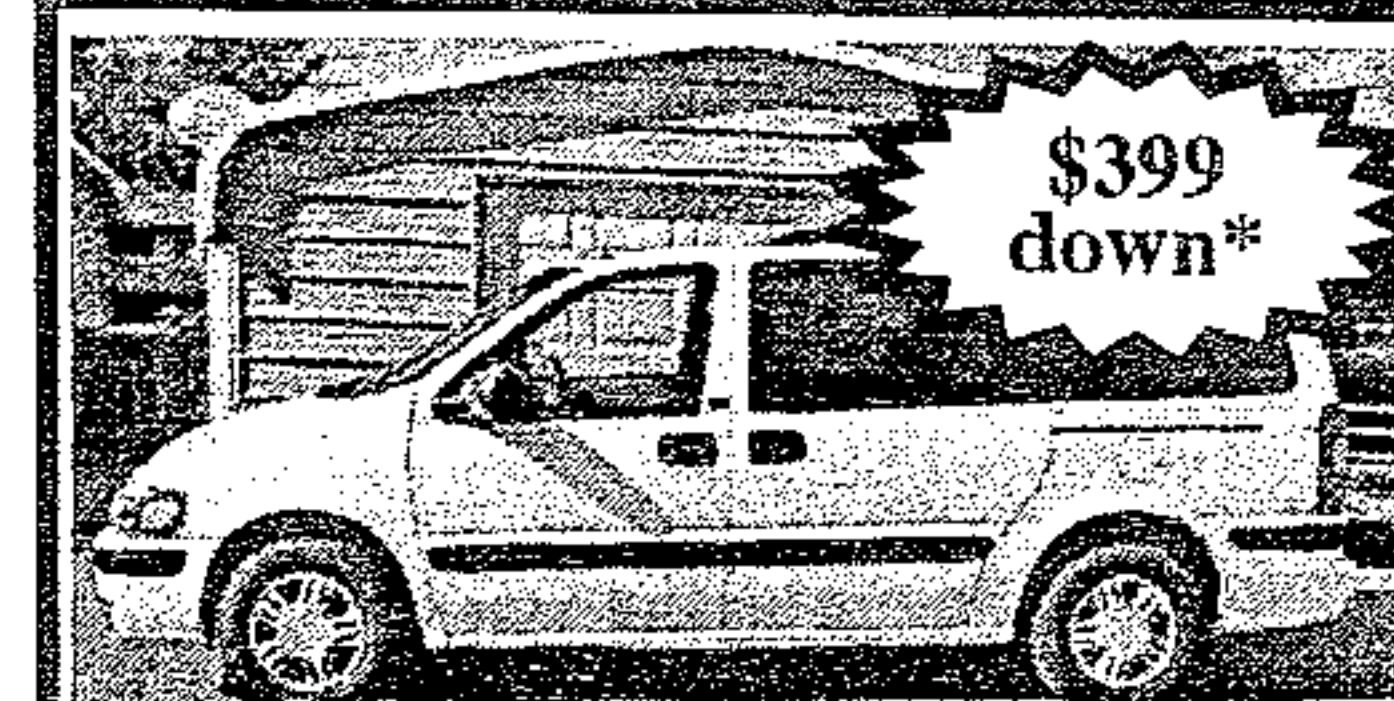

01 Venture, 7 passenger, Runs Great Only \$399 down*

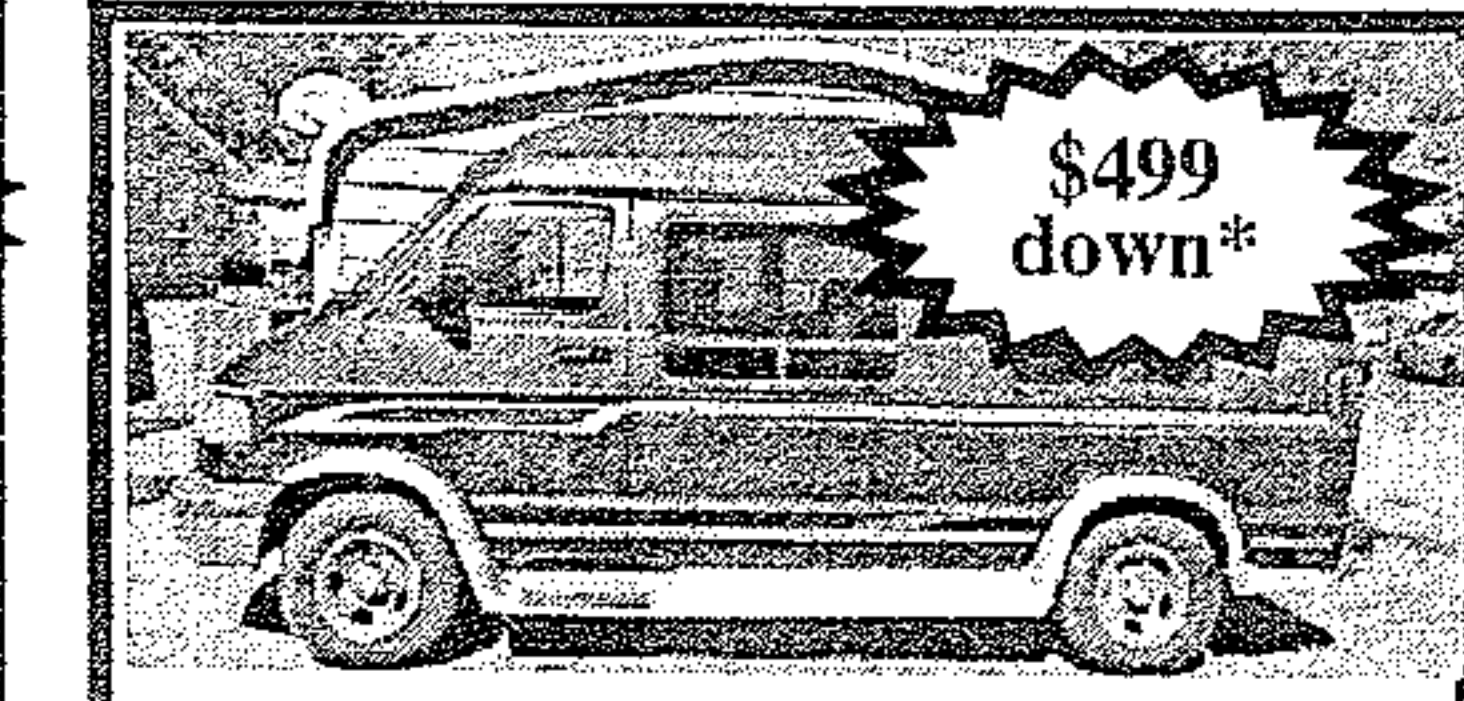

00 Ram, High Top Conversion Van, Loaded only \$499 down*

NO Credit Checks

Marty's Auto Sales
986-2222

Se Habla Español

100% Approval*

*See Dealer for details. All down payments plus tax, tag, title and fees.

MARTY'S AUTO SALES • 986-2222 • MARTY'S AUTO SALES • 986-2222 • MARTY'S AUTO SALES • 986-2222 • MARTY'S AUTO SALES • 986-2222 • MARTY'S AUTO SALES • 986-2222 • MARTY'S AUTO SALES • 986-2222

Theft reported

Deputy Mark Tinnel LCSO, responded to Spring Street to the theft of an aluminum john boat, taken from the yard on the left side of the residence. The Victim stated to the deputy someone took the boat and two oars and anchor without his permission. The case is under investigation by CID.

Police beat

Charles Bell, 45, Ithica Drive Knoxville, was charged with Violation of Probation. Deputy John Toney LCSO, served Charles with a VOP Warrant at the Loudon jail.

Theresa Brandfast, 52, Corntassel Road Madisonville, was charged with Driving on Revoked License. Deputy Kevin Dailey LCSO, made the arrest.

LONNIE JONES OPTICAL DISPENSARY

"We Make The Difference You Can See"
Locally Owned and Operated

Over 1000 Frames To Choose From
No Frame Over \$69.00

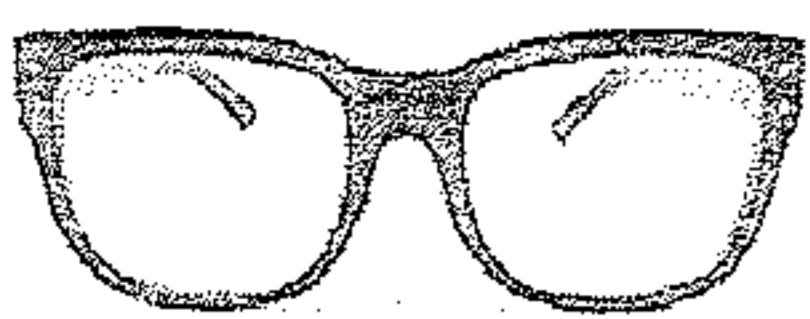

On the corner of A & Depot Street, Lenoir City

986-7803

Serving Loudon County for over 40 years

A Name You Already Know And Trust Just Got Even More Dependable
DEPENDABLE AUTO SERVICE, LUBE AND TIRES
is Now Offering

Expert, Affordable Transmission Service

All ASE Certified Technicians

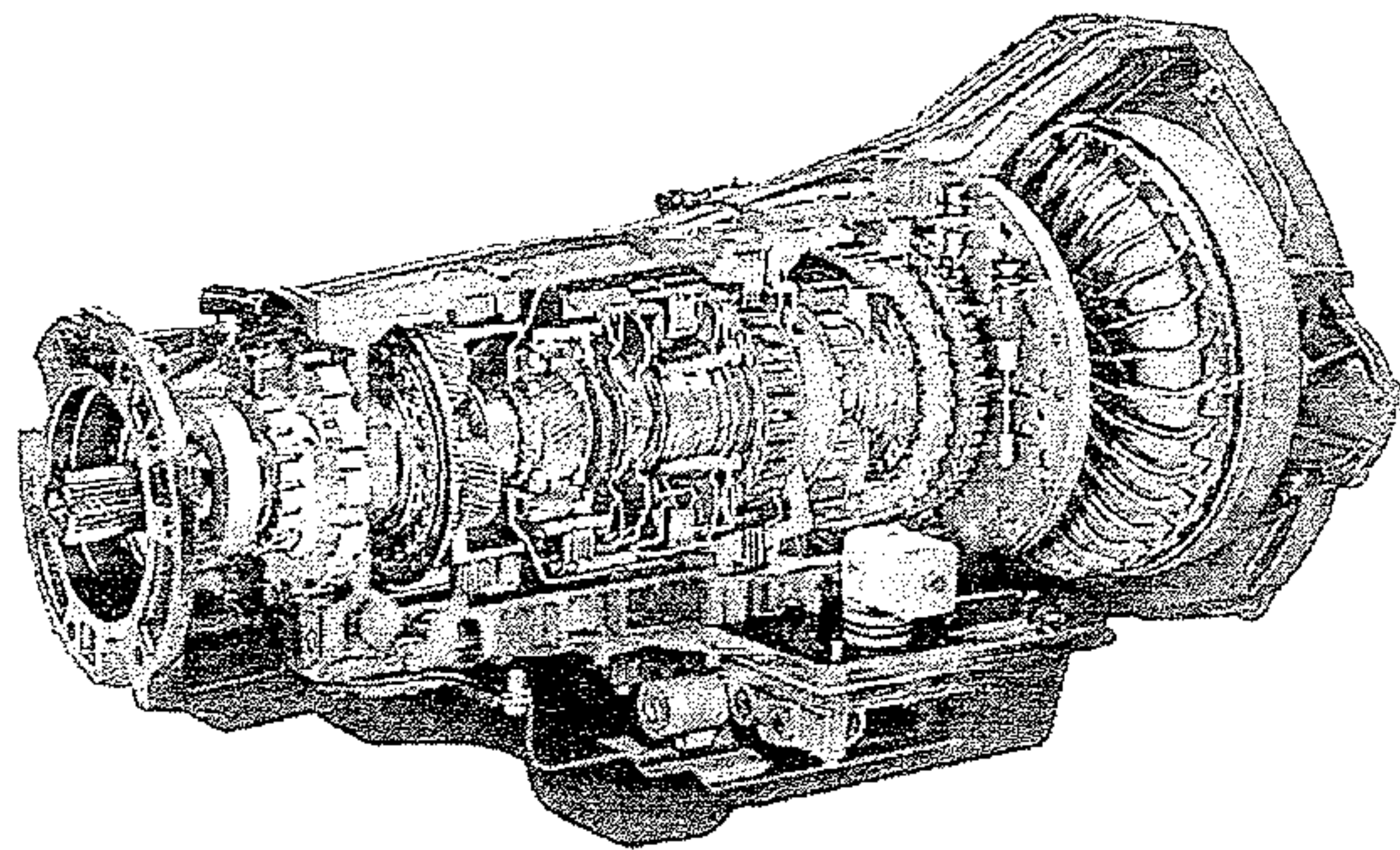

We proudly welcome all New Customers and Former Advanced Transmission Customers with a 10% Discount and Any Transmission Service or Repair*

865-986-9359

865-986-5050

Bad Credit, No Credit OK!!! We Finance Everybody!!!

Low Down Payment!!!

Over 100 Cars, Trucks & Vans in Stock - Warranties On ALL Vehicles Sold!!!

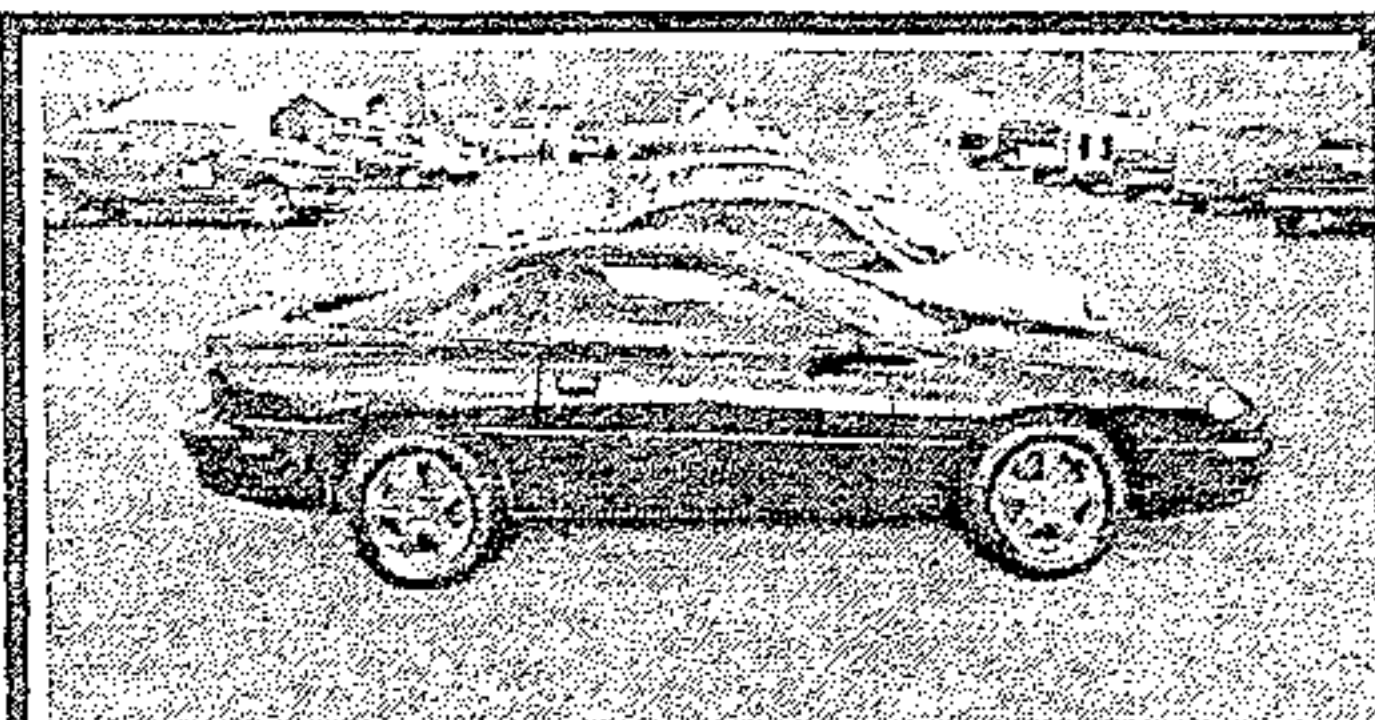

2002 Chevy Camaro, 5 speed, low miles, NICE

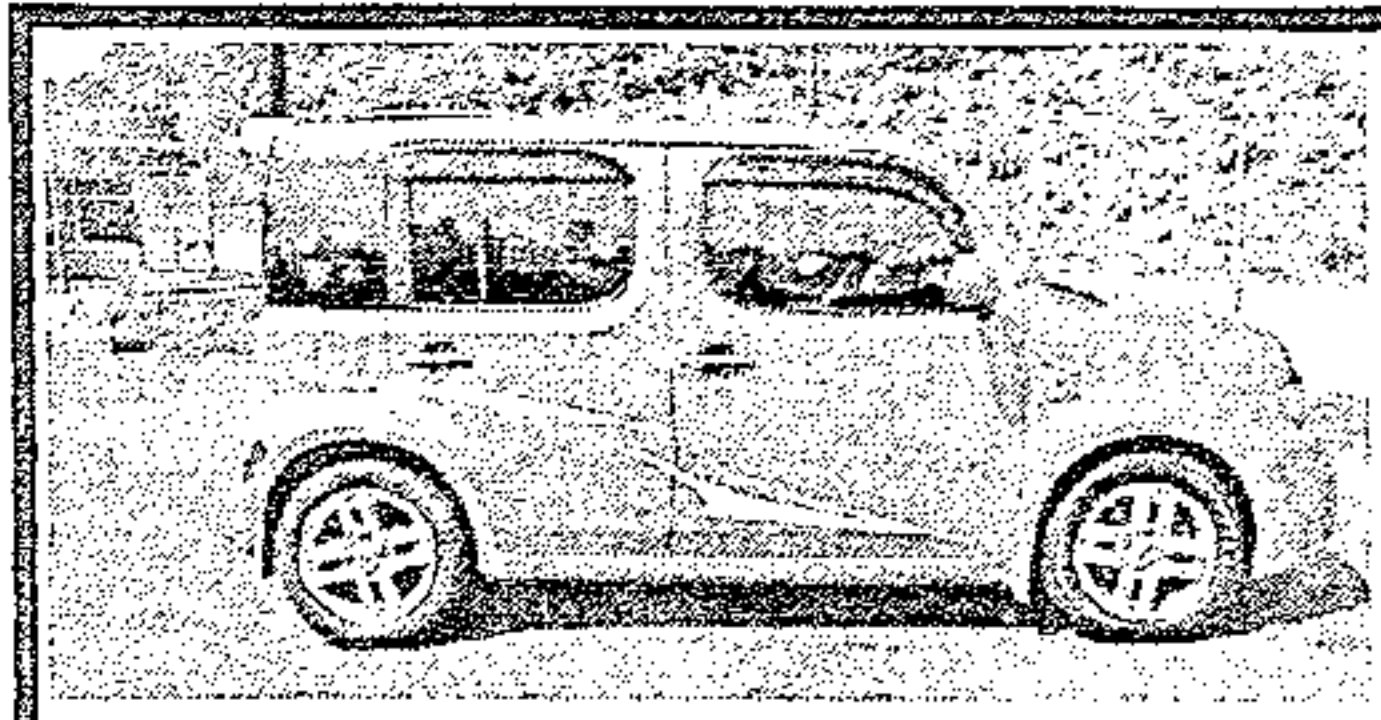

2009 Nissan Cube, Great Gas Saver, Clean



2006 Renault, leather, 3rd row seat

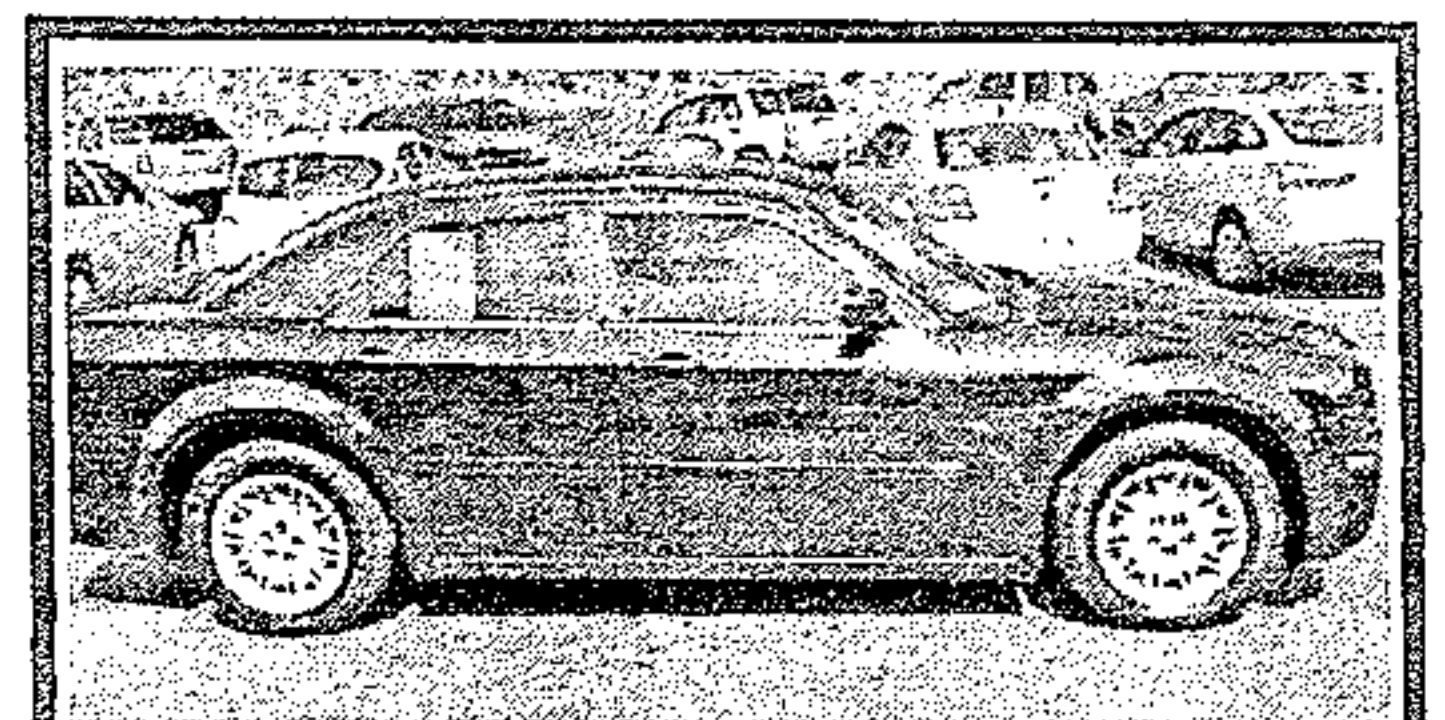

2006 Chrysler 300, Loaded, Nice Ride

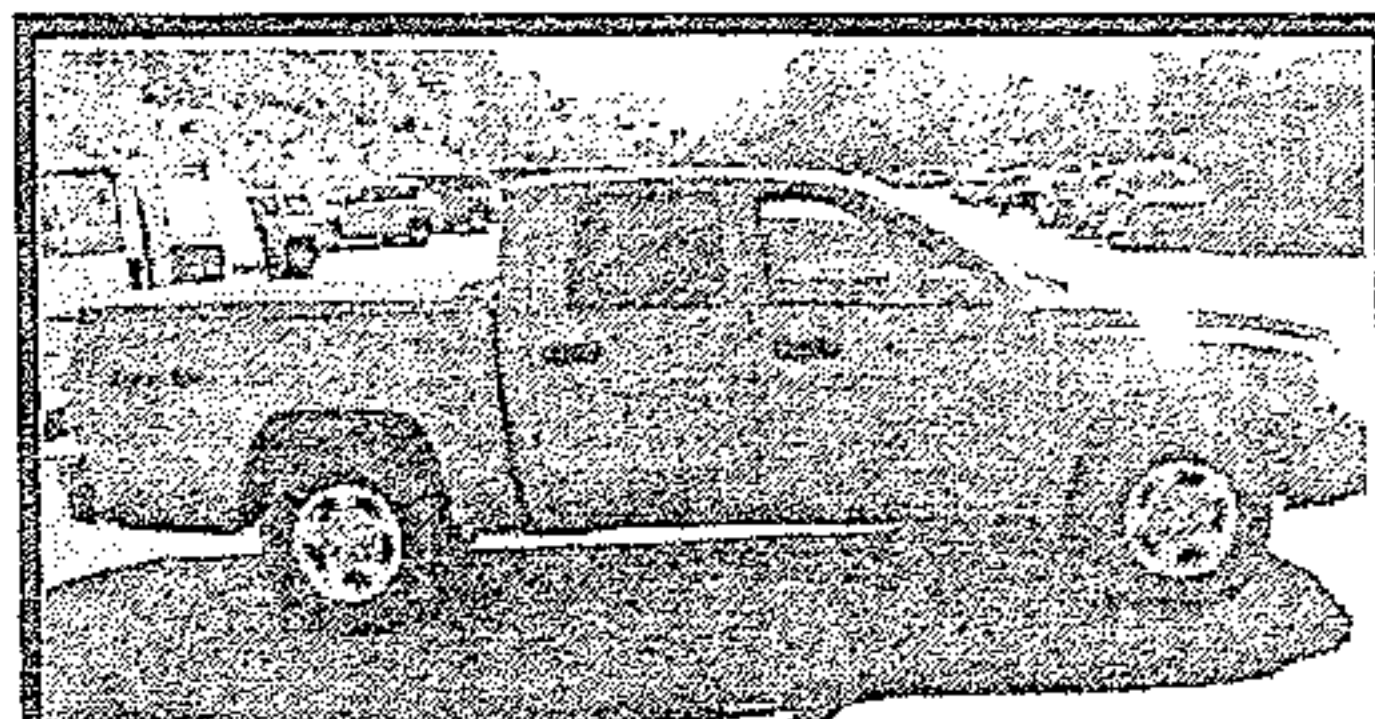

2005 Dodge Dakota, 4dr, 4x4, Extra Clean, lots of room

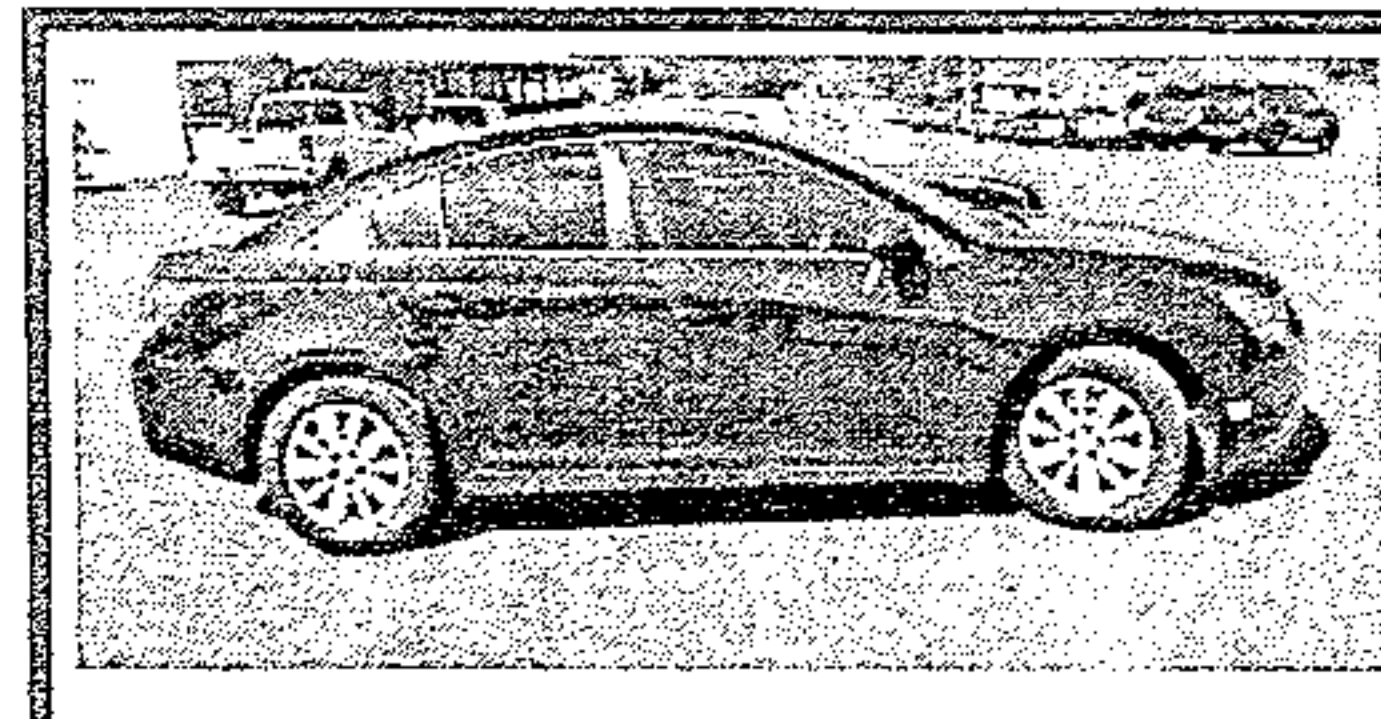

2011 Chevrolet Cruze, LOADED!!!



2007 Suzuki Grand Vitara, V6, Nice!

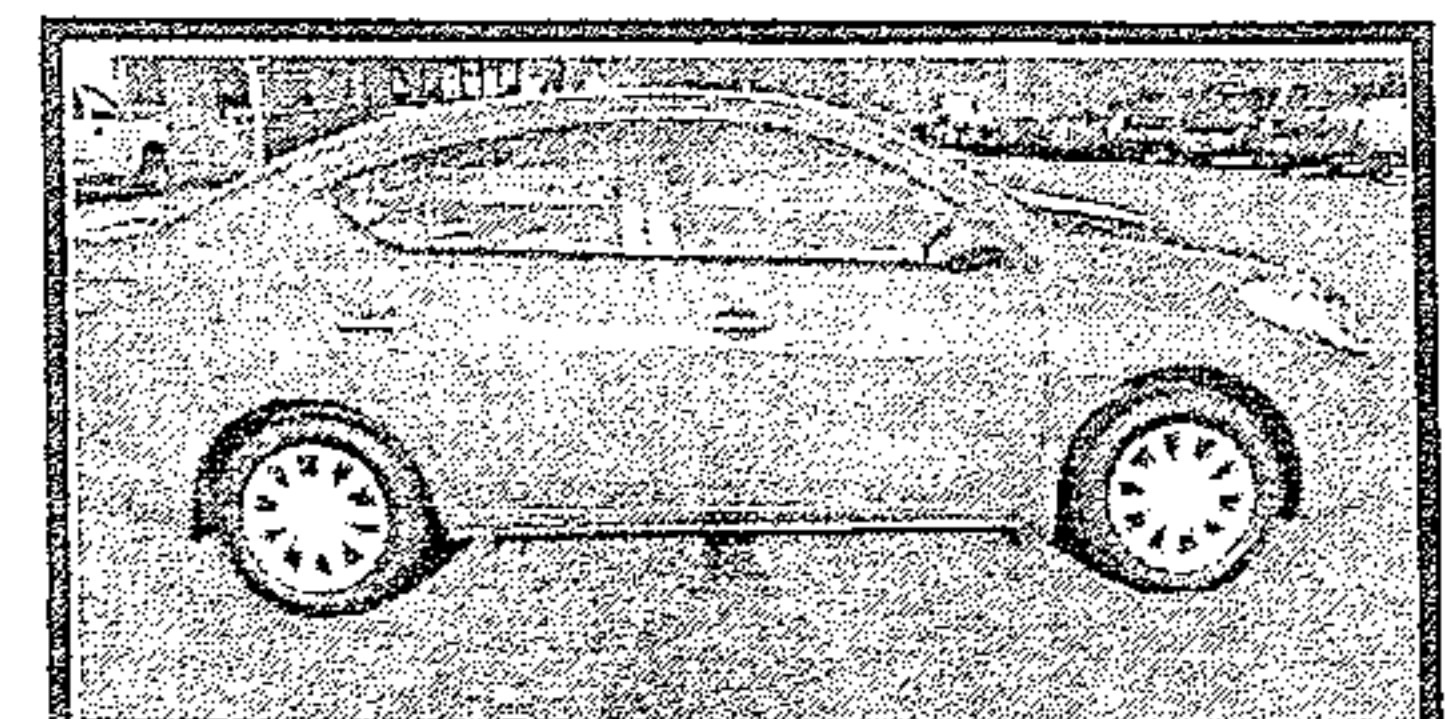

2013 Nissan Versa, Like New!, LOADED!!!

WALT WILLIAMS, INC.

*with approved credit

3003 Highway 11

Lenoir City, TN

865-986-1111