

# The Daily Edition

50¢

Serving Loudon, Monroe and Surrounding Counties

Wednesday, November 11, 2015

## Theft and pills charge by LCPD



Jeffrey Kalthoff

(see LCPD pg. 3)

## Victim transported to ER after incident



Phoenix Howard

(see dv pg. 2)

## Meth found after graveyard stop

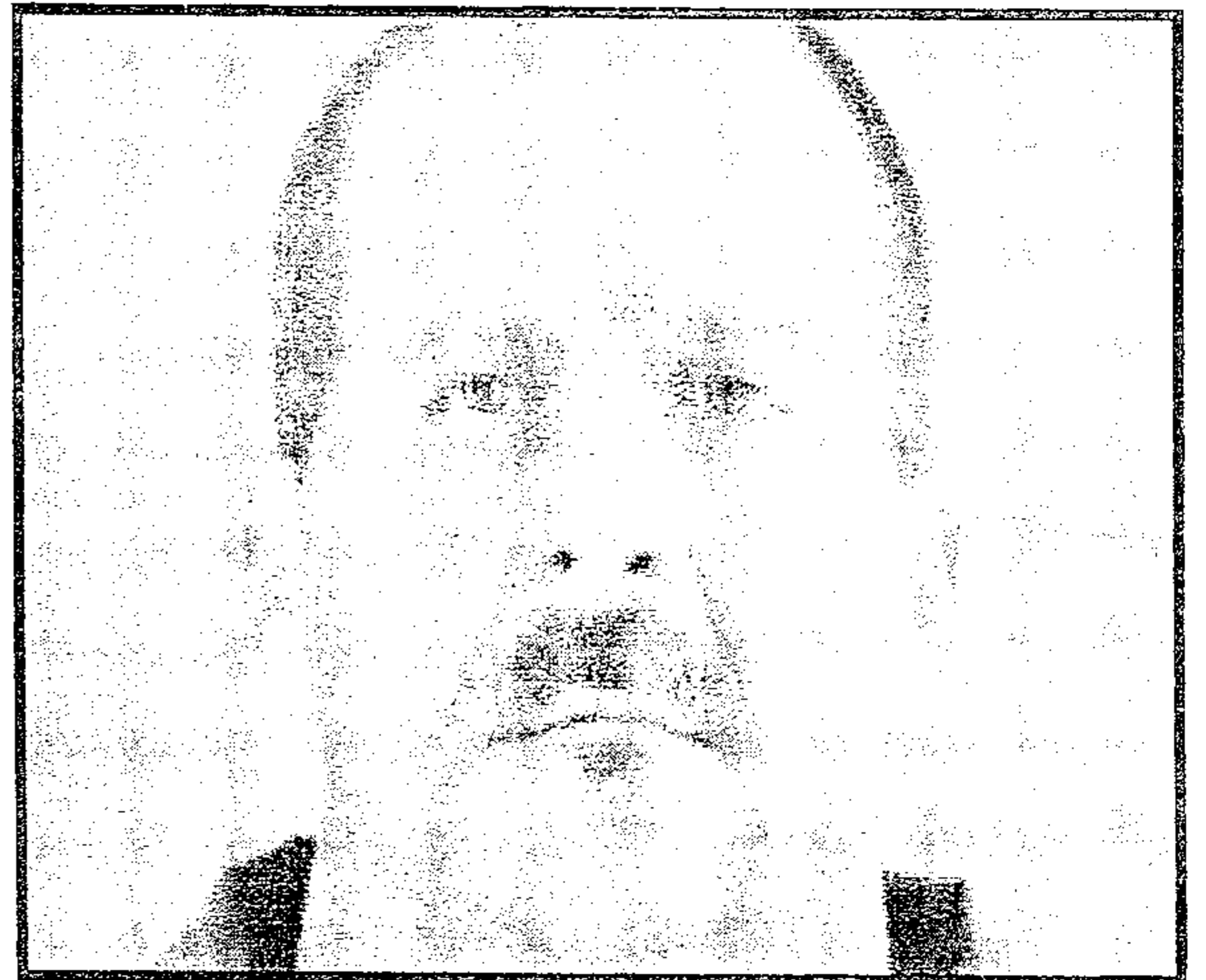

Billy Harrill

(see meth pg. 5)

## Stolen gun, needles and drugs found in LCSO search

George Coffman, 56, Chrisman Road Lenoir City, was charged with Prohibited Weapon, Legend Drug, Poss. of Drug Para, Simple Possession, and Theft of Property.

Loudon Co Narcotics Unit assisted by Patrol Division, executed a search warrant at Chrisman St. George Coffman was the only

(see search pg. 7)



George Coffman

## Solving Homicides

*FBI Forms Unique Partnership with Oakland Police Department*

On a peaceful, sunny morning in downtown Oakland, California, it is difficult to comprehend that the city across the bay from San Francisco is one of the most violent places in the country, with a murder occurring on average every three days. Inside the headquarters of the Oakland Police Department (OPD)—where homicide detectives and FBI agents were

meeting—that reality is all too clear.

Seventeen months ago, the FBI dedicated 10 special agents to work alongside OPD detectives to investigate active homicides and more than 2,000 cold case murders that have taxed the department's historically understaffed homicide detective squad.

On this morning, agents and detectives

(see FBI pg. 4)

### Verse of the Day

For I will pour water on the thirsty land, and streams on the dry ground; I will pour out my Spirit on your offspring, and my blessing on your descendants. — Isaiah 44:3

### Obituaries

see inside **Wazzup**  
Looking forward to seeing Mark Lowery at First Baptist Church this Thursday Night! If you don't have tickets yet get em online at [Marklowery.com](http://Marklowery.com).

### Weather

Today: Some clouds in the morning will give way to mainly sunny skies for the afternoon. High 68F. Tonight: Partly cloudy skies early will give way to cloudy skies and rain later during the night. Low 53F.

Thursday Light rain early Breaks of sun in the afternoon. High around 65F. Thursday Night Partly cloudy skies. Low 43F.

### Horoscopes

Scorpio 10/23-11/21

Follow your gut in-

(Continued on page 6)

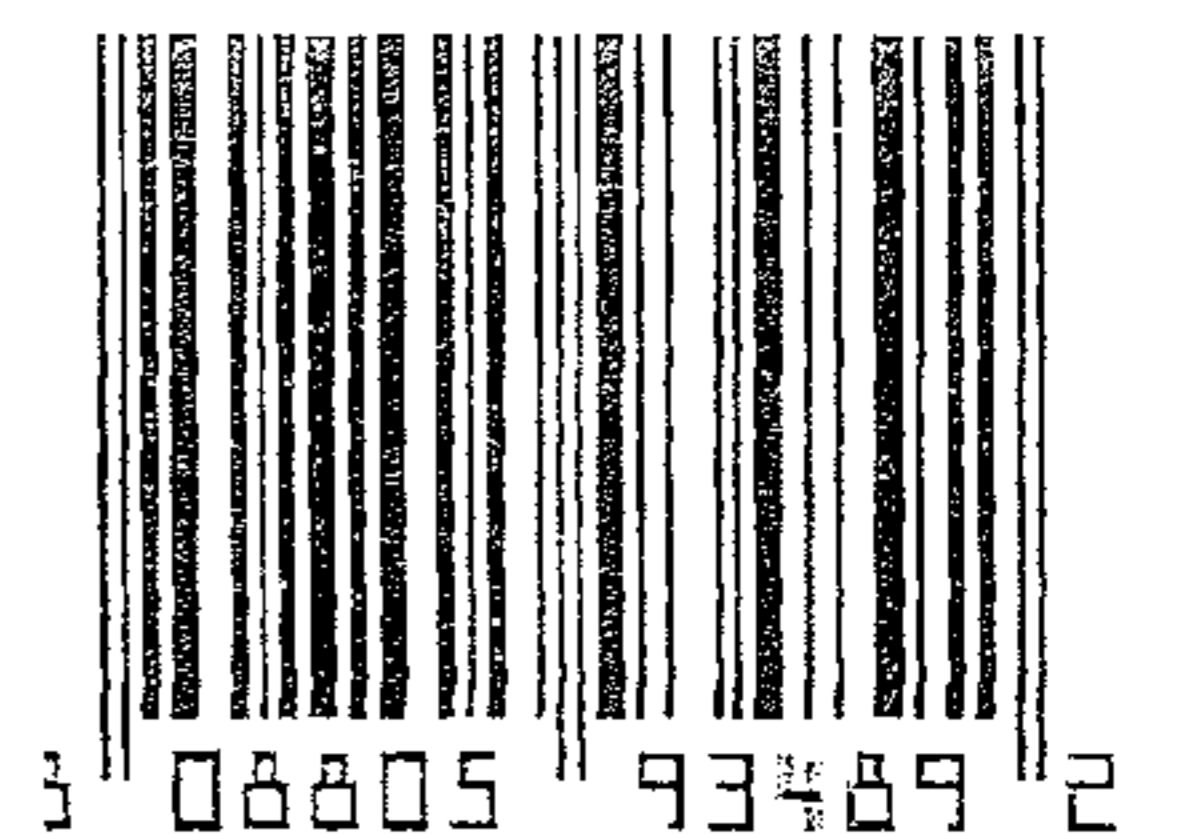

dv

Phoenix Howard, 18, Bethel Drive Lenoir City, was charged with Domestic Assault. Officer Nick Hasley LCPD, was dispatched to Bethel Drive for a physical altercation.

Upon arrival Phoenix was located on the front porch. Witness stated that victim

tried to leave and Phoenix got angry and tried to stop victim from leaving.

Phoenix did hit victim in the face and got a cane after him. Victim was located at a friends house and transported to the ER.

Phoenix was placed under arrest.

Officer Nick Hasley LCPD, made the arrest.

**Call 865-771-2249 to Advertise and start saving today!**  
**Has your group got an event coming up?**  
**Let us know!!!**

**Notice**  
 Vin 1G82557N87F202859  
 General Motors Vehicle will be sold. If anyone has a lien on this vehicle contact: Homer's Body Shop, 10609 Beals Chapel Road, Lenoir City, 37772, 865-388-0372.

Notice: The Daily Edition does not knowingly accept fraudulent or misleading materials. The Daily Edition cannot guarantee the validity of offerings or statements contained herein. All liability for the contents of all advertising, and for any claims that may arise therefrom, is the responsibility of the advertiser or its agency. The Daily Edition reserves the right to reject, edit, or abbreviate any advertisement submitted. Advertising is accepted with the understanding that all liability for all copyright violations is the sole responsibility of the advertiser.

Photographs, artwork and other copy submitted for publication is considered the sole property of the advertiser. The Daily Edition will make every effort but will not be liable for failure to publish and ad or for typographical and layout errors. All statements and information about highlights featured items, letters to the editor, herein are those solely given to the interviewer or writer and the Daily Edition assumes no responsibility of the accuracy or validity thereof. The Daily Edition will gladly reprint at no charge that part of an advertisement in which an error occurs provided a claim is made within 3 days of the first publication of the ad. Information contained in the Wazzup is received anonymously and the Daily Edition assumes no responsibility for information and reserves the right to edit or reject any and/or all submissions. The Daily Edition is a daily newspaper of general circulation in Loudon County defined under TCA 2-1-104(a)(13).

The Daily Edition also serves Monroe, Knox, Anderson, Roane and Blount counties and serves 30,000 readers weekly. Send mail to PO Box 1240, Lenoir City TN 37771. 865-771-2249. email: dan1204us@yahoo.com

The Daily Edition is Loudon County's premier public interest and paid advertising paper. The Daily Edition is produced and published daily Monday through Friday and is circulated throughout Loudon County and parts of Monroe and Knox Counties. Display advertising rates \$5.00 per column inch and quantity discounts available. Call for information on upcoming promotions and events.



**HACIENDA Ayala's**  
**Mexican Restaurant**  
 Market Dr. \* Lenoir City (In Front of Food City)

**Real Authentic Mexican Food at Affordable Prices**

**BEST**  
**MARGARITA**



**You've Tried The Rest Now Come Have The Best!!!**

**We Accept ALL Competitors Coupons Outside of Mexico City!**

**986-3553**

**Good Credit OK • Bad Credit OK • Bankruptcies OK • Repo OK**



2010 Kia Soul Sporty, 4 cyl, Auto, PW, PL, A/C, Great On Gas, Like New



2010 Ford Escape Limited Leather, Alloy Wheels, Heat, A/C, Luggage Rack, 79K,



2007 Dodge Ram 1500 Quad Cab, Thunder Road PKG, 20 in. Wheels, Low Miles, Hemi



2008 Ford Explorer 84k, 3rd Row Seating, Luggage Rack, Tow Pkg, PW, PL



2011 Ford Ranger Low Miles, Tow Pkg, New Tires, A/C, Heat, Bed Liner.



2011 Dodge Grand Caravan DVD, Stow & Go, Loaded, Remote Doors, Rear A/C

**DEPENDABLE MOTORS 986-9343**

**803 E. Broadway • Lenoir City**

*Serving Loudon County for 20 Years*

\* WAC. See Dealer for details

Visit our website at: [www.dependablemotorslc.com](http://www.dependablemotorslc.com)

**LCPD**

Jeffrey Kalthoff, 39, Payne Ave Alcoa, was charged with Theft of Property, and Simple Possession. Officer Brandon Johnson LCPD, was dispatched to Walmart in regard to a shoplifter. Upon Officer arrival he made contact with Loss Prevention, who stated they observed Jeffrey take 2 sim cards from their pouch, conceal them in his jacket and proceeded past the point of sale. Jeffrey was placed under arrest, while Officer was searching Jeffrey he located a bolt cutter, pliers, headphones, powers assessor, and a GPS case. The amount of product combined is \$141.45. Also located on Jeffrey was a small plastic bag with approx. 30 clonazepam pills. Officer Brandon Johnson LCPD, made the arrest.

**Obituaries**

**Christine (Chris) Haworth** -age 45 of Lenoir City, passed away suddenly Thursday, November 5, 2015. She was an employee of Aubrey's Restaurant in Farragut. Chris was a loving and devoted mother to her son, Dylan Haworth. The family will receive friends from 2 - 3 p.m. Wednesday November 11 at Click Funeral Home in

Lenoir City. A memorial service will follow at 3 p.m. in the Click Funeral Home Chapel. A private interment will be held. Click Funeral Home in Lenoir City is in charge of arrangements.

**Connie Sue Russell**, age 51, of Loudon passed away Wednesday, November 4, 2015. Connie is preceded in death by her parents, V.L. (Feebee) Russell; mother, Faye Sitzlar Sleeper; soul-mate, Jasper Russell; brother, Donnie Russell. Survivors; Murphy Pennington and fiance', Linda presley; nieces, Lindsey Pennington

and Kyla Presley; nephew, Isaiah Presley; and her dog, Smokey. Family will receive friends from 1:00 - 2:30 pm Sunday, at Loudon Funeral Home. Graveside service following at 3:00 pm, Prospect Cemetery, with Rev. Rick Kirkland officiating.

**Roy C. Riddle** - age 78 of the Alnwick Community, passed away Friday, November 5, 2015. Mr. Riddle was an electrician and retired from

the Blount County Schools, Maintenance department. A veteran serving in the US Navy. He was preceded in death by his precious wife of 55 years, Katherine (Worthy) Riddle, in July of this year; his parents, John Daniel and Ruby Merritt (Thompson) Riddle; brothers and sisters in-law, Joseph and Jan Riddle, Bill and Jean Cavett; sister and brother in-law, Blanche (see obits etd. pg. 5)

**The Daily Edition**  
serving Loudon and surrounding counties since 1986

**For Sale: oak Wood Mulch**



Mushroom Compost Topsoil.



Firewood

Call Steve Spoon  
**986-4282**

**West End Storage & Warehouses**  
**502 Ward Avenue • Loudon**  
**Call 865-458-4774 or 865-679-5555**



**C&J Towing and Recovery**  
**LOWEST TOWING RATES AROUND!!!**

Have you been overcharged for any type of towing service in the Lenoir City area? If you have a breakdown or accident please OWNER REQUEST C&J Towing with the officer. Also please call your Sheriff and ask him to place C&J Towing on the "Rotation List\*" and help other motorists save as much as you did! We at C&J are locally owned and operated, State approved, licensed, bonded and insured. Call and let us know if your denied service or how we can be of assistance.

\*note: the "Rotation List" is a list of wrecker services that provide service for wrecks, DUI's, breakdowns, etc. and are on an on-call basis for service. This list is approved by the Sheriff.

Cliff Teeters • Owner  
**865-809-1661**



**BIMBO'S**  
**Deli Open 24 Hours**  
**865-986-9643 Call Ins Welcome**

**Specials**  
Lg. Cold Sub, bag of chips and 16 oz. fountain drink  
only \$6.29  
Footlong Corn Dog \$2.59

FBI comprising the Homicide Task Force were discussing their most pressing investigations—almost all related to gangs and drugs—and how best to solve them. An OPD detective mentioned that a key witness in one of his cases had fled to Texas. FBI Special Agent Russ Nimmo, who leads the partnership effort, said agents in Texas could locate the witness there and arrange for an interview. “We can help with that,” he said.

It’s just one example of how the FBI adds value and depth to OPD murder investigations. Not only does the Bureau assist by pursuing leads in other states but agents also conduct interviews, execute warrants, and, when necessary, deploy spe-

cialized resources such as the SWAT team and the Evidence Response Team. The FBI can also collect and process critical firearms and DNA evidence, which may be too time-consuming and costly for OPD to take on alone. This real-time partnership gives local detectives a federal reach they did not have before—and in

many cases that means violent offenders are also charged federally, which can result in stiffer sentences.

“This effort with OPD is designed to be sustained and ongoing,” Nimmo says. “It is important to solve every murder, whether it occurs in a wealthy neighborhood or a poor one. We are showing

the community that the FBI is not just something you see on TV or read about in newspapers. We are working to provide justice in communities where many people feel that nobody cares about them.”

“This is a valuable partnership,” added Lt. Roland Holmgren of the OPD Homicide Unit,

“and we are seeing the fruits of our combined labors.”

Since the FBI-OPD effort officially began in June 2014, the task force has cleared twice as many murders as had been cleared in the past—a rate that increased from about 30 percent of homicides to

(see FBI ctd. pg. 5)

### SARCO Enterprises Inc. Offers Complete Home and Commercial Remolding and Repairs

Our Team members have a combined total of over 40 years experience in all areas of home construction, facilities maintenance and commercial construction. Roofing, Electrical, Bath and Kitchen Renovations, we do it all with just one call. We are fully insured and our work is guaranteed.

Call us today for a free no obligation quote for your next project.  
865-809-9492.

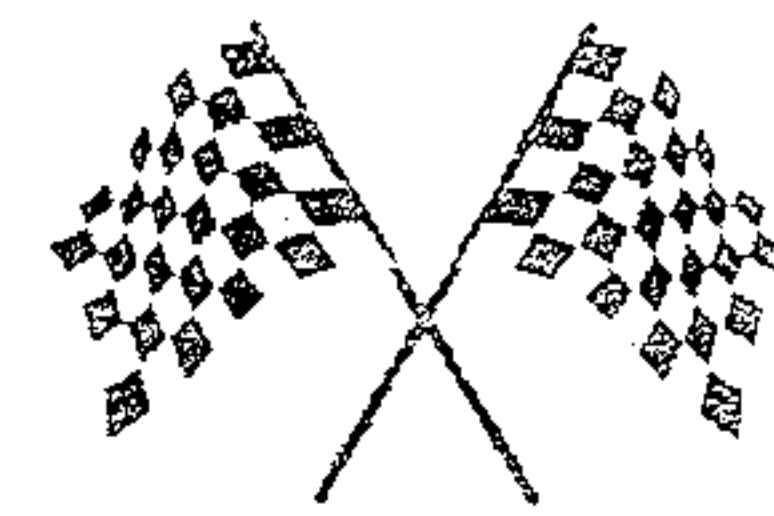

**SOUTHERN AUTO DETAILING**  
414 WEST BROADWAY  
LENOIR CITY, TN 37771  
865-986-0724

Starting at \$34.95  
Present this ad for \$5.00 off

## BUDGET Transmissions

### Why Buy From Budget?

- Free Towing From Lenoir City or Loudon County
- 20 Years of BBB Zero Customer Complaints Award Member
- A+ Plus Rated
- Huge Transmission Inventory
- Best Technicians Period!!!

Call (865) 584-4391 Today!

302 S. Northshore Drive Knoxville  
(865) 584-4391

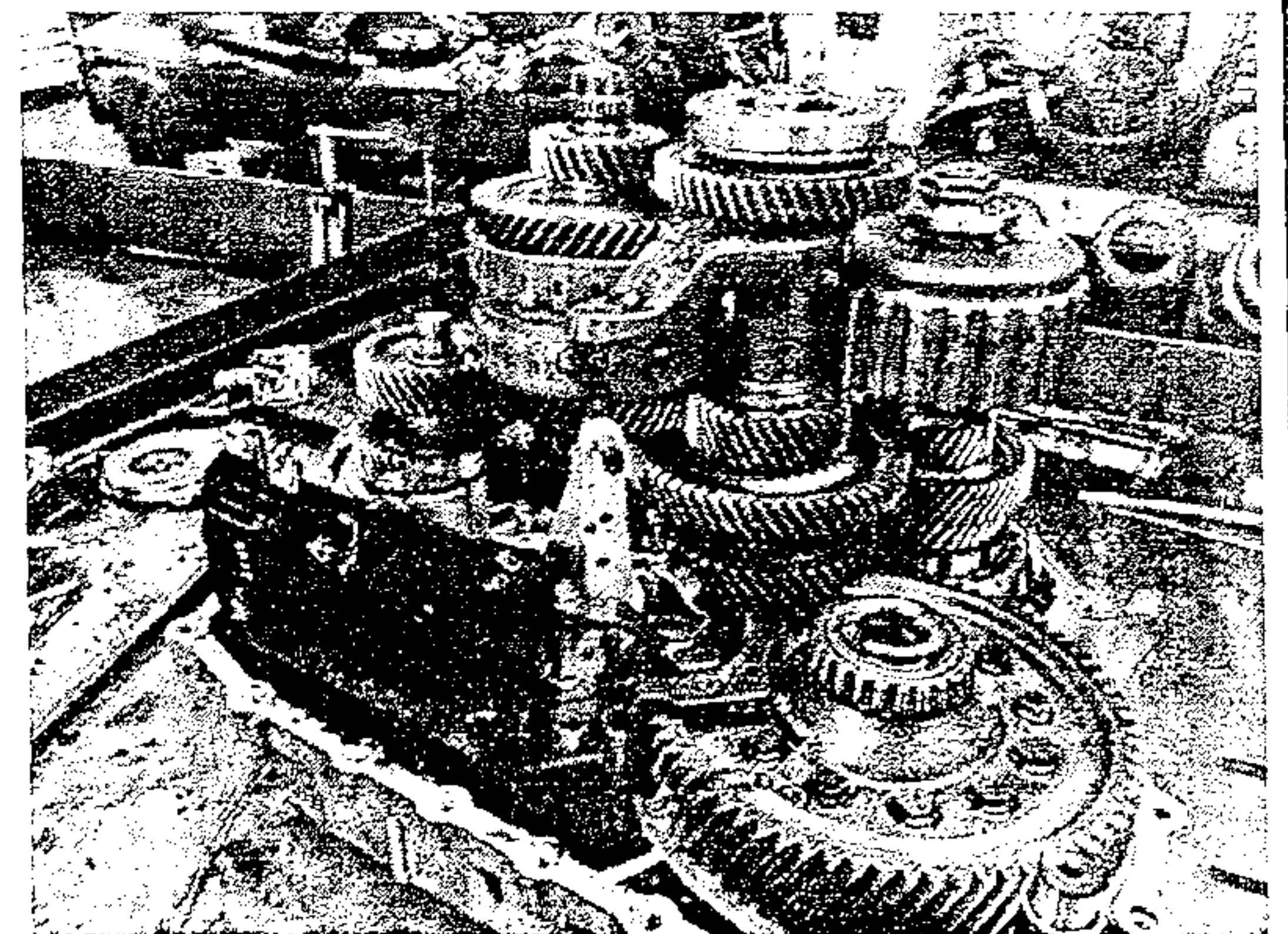

[budget-transmissions.com](http://budget-transmissions.com)



meth

Billy Harrill, 26, Hartland Drive Madisonville, was charged with Simple Possession. Deputy Billy Lewis LCSO, observed a black vehicle backed in Morganton Cemetery occupied by a male and female. Deputy made contact with the occupants. While speaking with the driver identified as Billy

Harrill, who stated they were just there hanging out. Billy had opened the vehicle door and upon Deputy looking in the door handle he observed a clear plastic baggy with a clear crystal substance inside believed to be Methamphetamine. Deputy ask both parties to step out of the vehicle until Sgt. Watkins arrived on scene. Billy stated that

it was meth in the baggy but he didn't know how it got there. The passenger stated she did not know it was in the vehicle. Billy stated that it was in his vehicle so he guessed he would take the blame, but someone had drove the vehicle earlier that day. Billy was placed under arrest. Deputy Billy Lewis LCSO, made the arrest.

Obits ctd. from pg. 3

and Donald Watkins, and infant sister, Katherine. He is survived by his sister and brother-in-law, Margaret and Harold Heiser, Pennsylvania; brother and sister in-law, Glenn and Katherine Riddle, Maryville; several nieces, nephews and friends. Graveside services will be held 2:00 PM Wednesday, November 11, 2015

in the Loudon County Memorial Gardens, 6505 Hwy 11 West, Lenoir City. McGill-Karnes Funeral Home, Loudon.

FBI ctd.. from pg. 4

60 percent. And the task force is actively working its backlog of cold cases as well.

At OPD headquarters, a dedicated workspace for the task force was set aside and is being renovated using funds from both the Bureau and the city. Detectives and agents are expected to occupy their new, permanent quarters by the end of the year. The space will feature state-of-the-art equipment to aid in recording and reviewing subject interviews. Agents and detectives will also have access to FBI computer systems to aid their investigations.

Nimmo explained that the Bureau has many Safe Streets Task Forces around the country—consisting of local, state, and federal law enforcement partners—working to fight violent crime. The effort to embed FBI agents with OPD detectives represents an additional commitment. “And it sends a message,” he said: “If you kill someone in Oakland, we will catch you.”

One case the FBI worked jointly with OPD was a December 2013 drug-related murder in East Oakland that occurred in the parking lot of a large chain store a few days before Christmas. Damion Sleugh had arranged to buy five pounds of marijuana from 24-

(see FBI conc. pg. 7)

# PURDY'S AUTO PARTS AND SALVAGE

WE BUY SCRAP IRON • COPPER • BRASS • ALUMINUM

**\$** **Paying Top \$\$\$**  
Call For Latest Prices

*You Name It, We Buy It!*

Radiators, Wheels, Batteries, Appliances, Farm Equipment

**Copper**  
Paying Top \$\$\$  
Call For Latest Prices

**Complete Cars**  
per 100 lbs.

**Scrap Metal**  
Paying Top \$\$\$  
Call For Latest Prices  
per 100 lb

**We Buy Batteries**

**Aluminum Cans**  
Paying Top \$\$\$  
Call For Latest Prices

**You Call We Haul!**  
**423-519-5402**



\* Prices subject to change with the market.

**Now Selling  
Aftermarket  
Body Parts at  
Discount Prices**

**423 337-3977**  
**149 County Road 323 Sweetwater**

\* Prices subject to change with the market.

**search**

person located at the residence during the search warrant. Two set of scales, one cut straw, one suboxone strip, six syringes, three burnt spoons, one pill cutter, and one sharps box with several more syringes were found during the search. On the couch where George was sitting was a Red Ruger LC9-R 9mm hand gun was located. The serial number of the weapon was ran and came back stolen from Lenoir City. A bottle of injectable Naloxone, an opioid antagonist available by prescription only was located as

well. George is a convicted felon and not allowed to own a gun. George was placed under arrest. Investigator Marty Stanley LCSO, made the arrest.

FBI conc. from pg. 5

year-old Vincent Muzac. The deal went bad, and Sleugh shot Muzac, dumping his body in the parking lot before driving off.

With the FBI's assistance, Sleugh was indicted federally in March 2014 on first-degree murder and other charges. A jury convicted him in July 2015, and last week the 28-year-old was sentenced to life in prison.

Nimmo has been working to help OPD

detectives since 2010. "The Sleugh case, along with several others, made us realize the greater federal impact we could have if more agents were fully staffed with OPD detectives," he said. "The results so far are not surprising, given the quality of agents and detectives assigned to the task force." He added, "This level of partnership over this length of time is making a real difference, but there is still much more work to be done."

Loudon County Sheriff's Office Toys for Tots 2015

Thanks to the generosity year after year of the Loudon County residents, churches, businesses and industries,

the Loudon County Sheriff's Office is once again able to offer the Toys for Tots program. We are beginning our 31st year of providing toys to the needy children of Loudon County, and thanks to generous contributions of time, money and gifts, we are able to make Christmas a more joyful time for more and more children. In 2014, approximately 500 children were helped by the Loudon County Sheriff's Department Toys for Tots program through their partners. Even with the

difficult economic times we are experiencing, we hope that the people of Loudon County will be there once again to help.

Names will be available beginning in mid-October through business and churches. If you are considering helping a child this Christmas, please be assured that applicants are thoroughly checked to make sure they require this assistance. Names are also compared with the school systems to make sure no one is receiving duplicate assistance.

**Is Your Washer Broken?**  
**Call Me I Only Charge \$100 Period!!!**  
**Call Allen 865-617-7113**

**LOOK! \$75 Weekly Payments LOOK!**

MARTY'S AUTO SALES • 986-2222 • MARTY'S AUTO SALES • 986-2222 • MARTY'S AUTO SALES • 986-2222 • MARTY'S AUTO SALES • 986-2222 • MARTY'S AUTO SALES • 986-2222

**Bad Credit**  
**Divorce**  
**Fixed Income**  
**Repos**  
**Bankruptcy**  
**No Credit**

**APPROVED!**

**Visit Us On The Web At:**  
**martysautosales.net**

**NO CREDIT CHECKS**

 <p><b>\$499 down*</b></p> <p><b>07 Cobalt, 5spd, gas saver, runs great Only \$499 down *</b></p>	 <p><b>\$499 down*</b></p> <p><b>02 Sable, sunroof, loaded, Only \$499 down*</b></p>	 <p><b>\$499 down*</b></p> <p><b>04 Cavalier, 2dr, Sporty, Only \$499 down *</b></p>	 <p><b>\$499 down*</b></p> <p><b>01 Sebring 2dr. sporty, Only \$499 down *</b></p>
 <p><b>\$299 down*</b></p> <p><b>97 Escort, auto, Gas Saver, Only \$299 down *</b></p>	 <p><b>\$499 down*</b></p> <p><b>03 Focus 5 speed, Gas Saver, Only \$499 down *</b></p>	 <p><b>\$399 down*</b></p> <p><b>01 Venture, 7 passenger, Runs Great Only \$399 down *</b></p>	 <p><b>\$499 down*</b></p> <p><b>00 Ram, High Top Conversion Van, Loaded only \$499 down *</b></p>

**NO Credit Checks**

**Marty's Auto Sales**  
**986-2222** Se Habla Espanol

**100% Approval\***

\*See Dealer for details. All down payments plus tax, tag, title and fees.

MARTY'S AUTO SALES • 986-2222 • MARTY'S AUTO SALES • 986-2222 • MARTY'S AUTO SALES • 986-2222 • MARTY'S AUTO SALES • 986-2222 • MARTY'S AUTO SALES • 986-2222

**Burglary reported**

Deputy Lance Anderson LCSO, responded to Elokwa Place to the report of burglary. Upon arrival Deputy made contact with the victim who stated that she had a diamond ring missing. The victim showed Deputy an appraisal for the ring that was dated 9/21/15. Victim

did not want to pursue charges, victim stated she only needed a report for her insurance.

**Police beat**

Stephanie Brown, 25, Vonore Road Sweetwater, was charged with Failure to Appear. Deputy Brandon Dishner LCSO, served a FTA Warrant on Stephanie at the Loudon Jail.

**A Name You Already Know And Trust Just Got Even More Dependable**  
**DEPENDABLE AUTO SERVICE, LUBE AND TIRES**  
**is Now Offering**  
**Expert, Affordable Transmission Service**

All ASE Certified Technicians

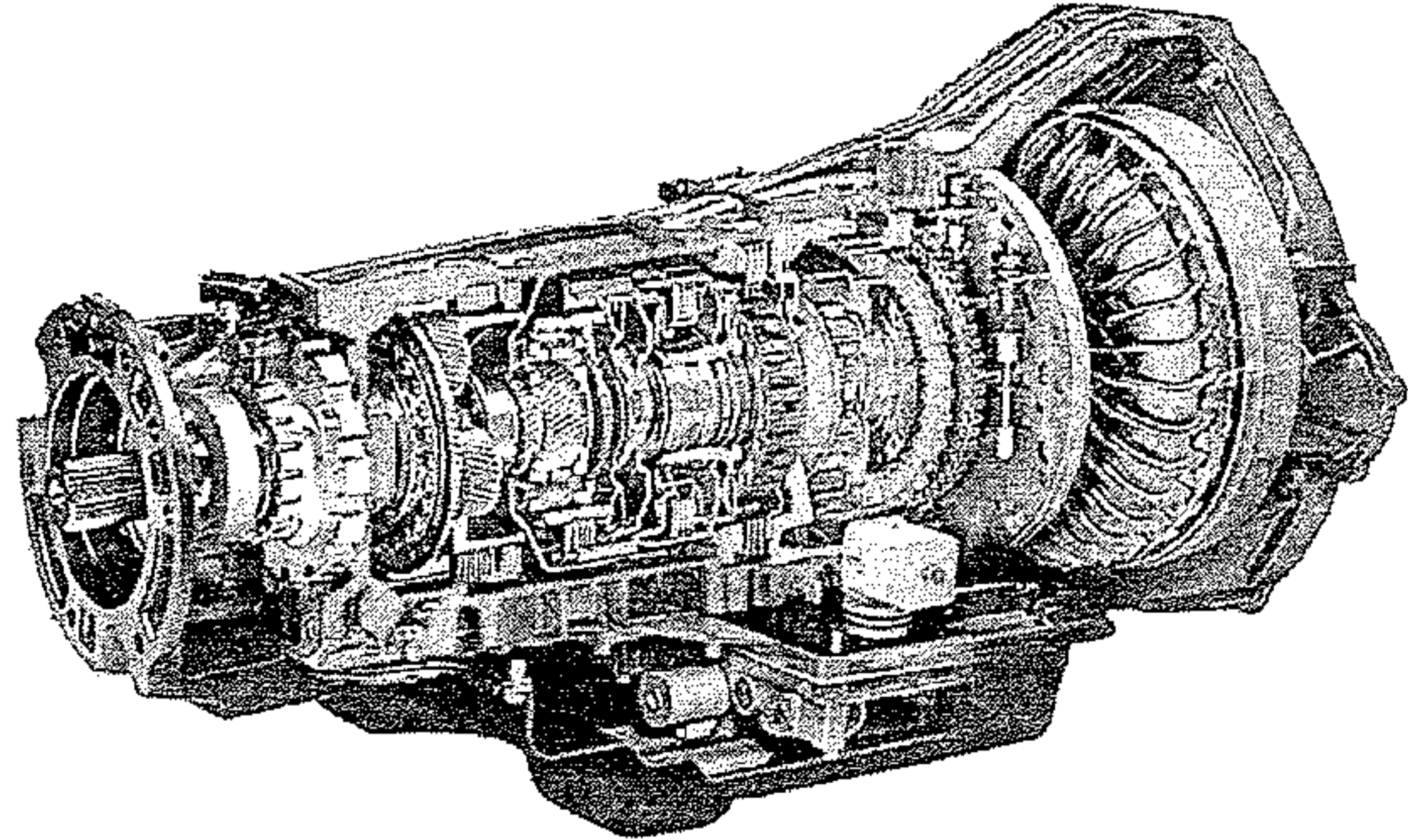

**We proudly welcome all New Customers and Former Advanced Transmission Customers with a 10% Discount and Any Transmission Service or Repair\***

**865-986-9359**

**865-986-5050**

**LONNIE JONES OPTICAL DISPENSARY**

"We Make The Difference You Can See"  
 Locally Owned and Operated

Over 1000 Frames To Choose From  
 No Frame Over \$69.00



On the corner of A & Depot Street, Lenoir City

**986-7803**

Serving Loudon County for over 40 years

**Bad Credit, No Credit OK!!! We Finance Everybody!!!**

**Low Down Payment!!!**

**Over 100 Cars, Trucks & Vans in Stock - Warranties On ALL Vehicles Sold!!!**



**2002 Chevy Camaro, 5 speed, low miles, NICE**

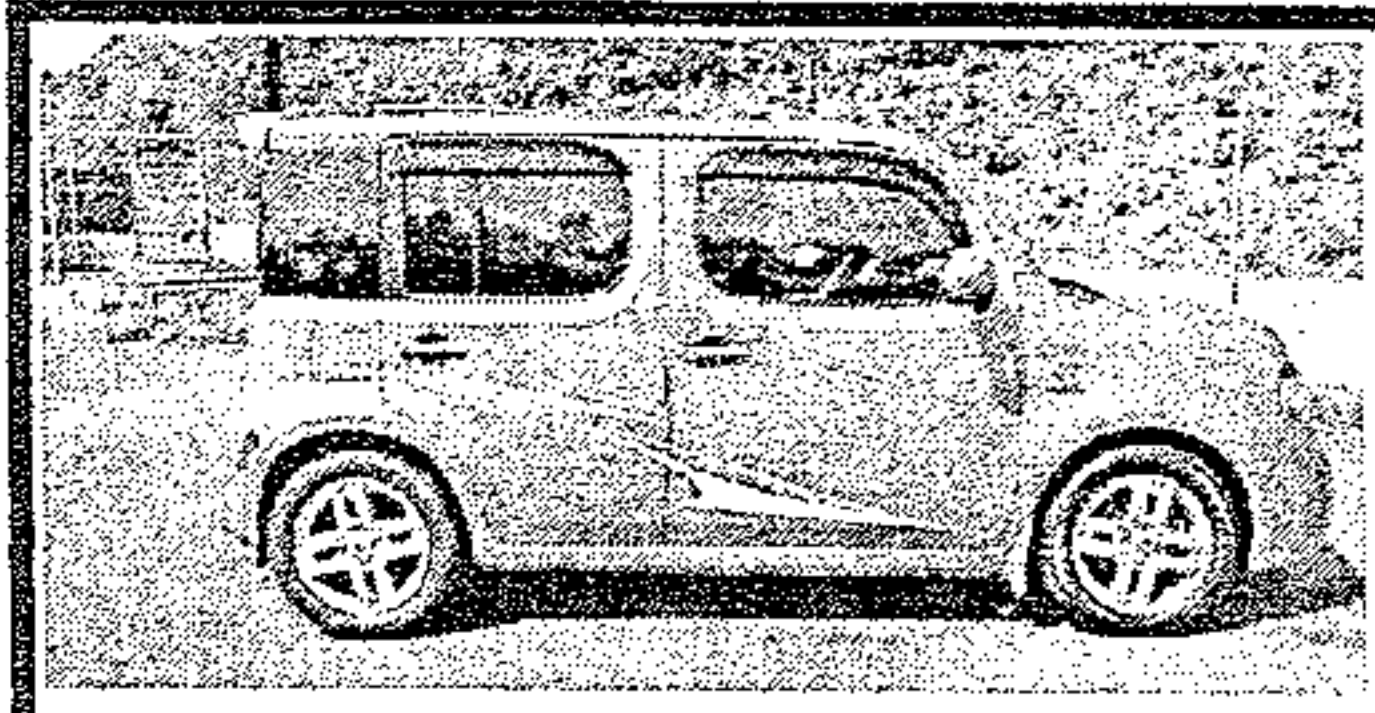

**2009 Nissan Cube, Great Gas Saver, Clean**



**2006 Rendevous, leather, 3rd row seat**

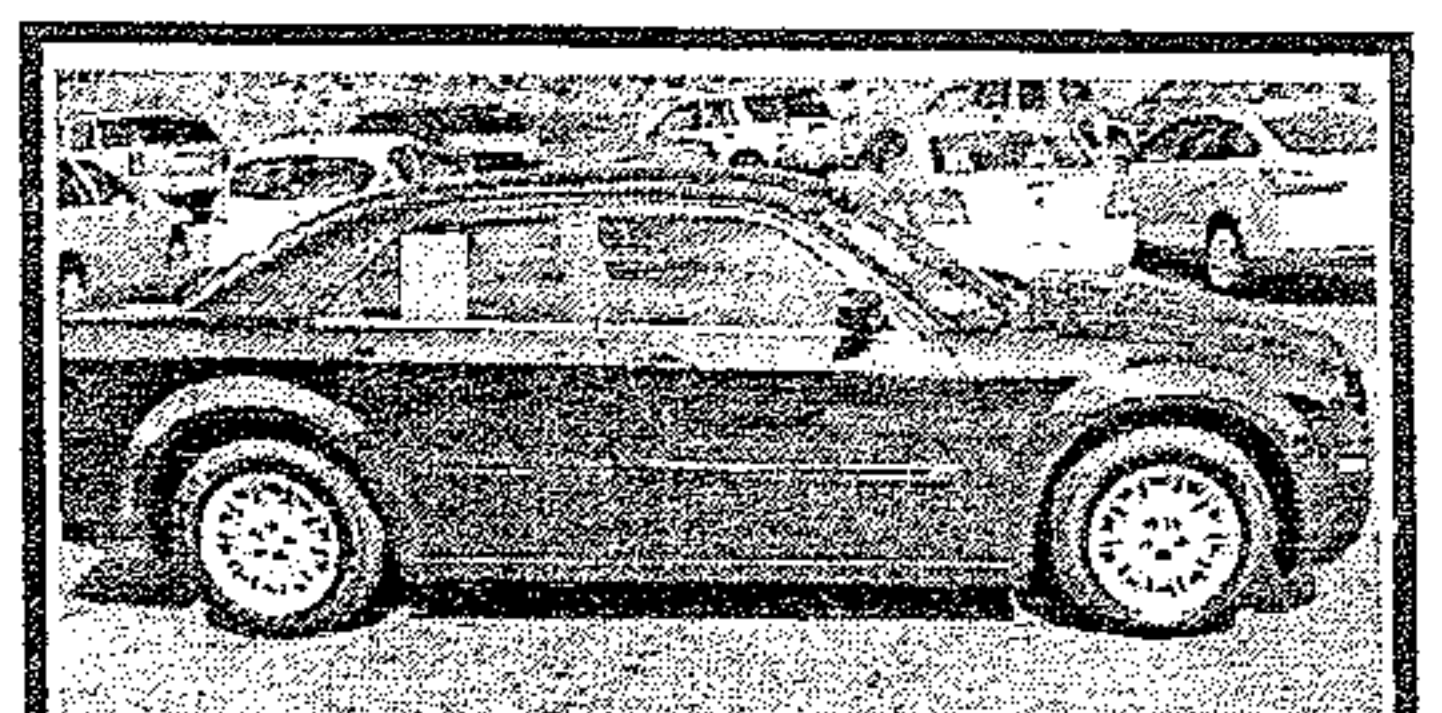

**2006 Chrysler 300, Loaded, Nice Ride**

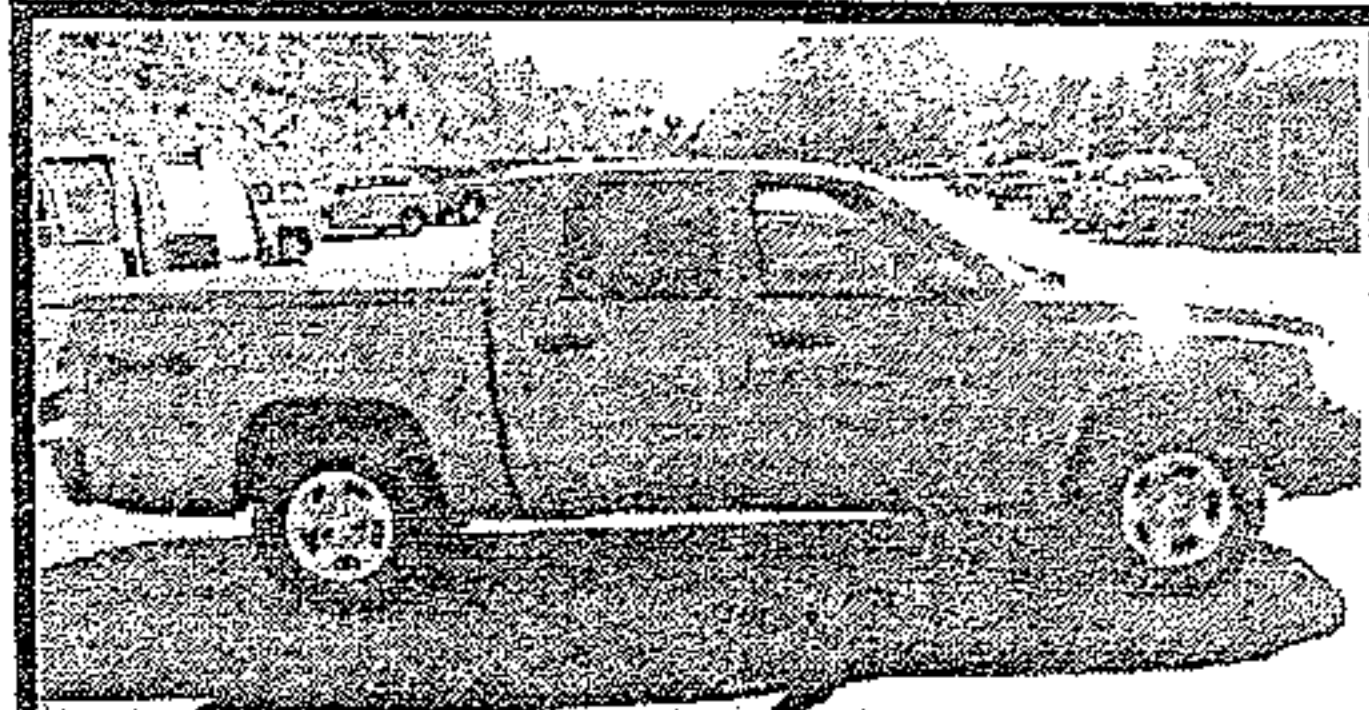

**2005 Dodge Dakota, 4dr, 4x4, Extra Clean, lots of room**



**2011 Chevrolet Cruze, LOADED!!!**



**2007 Suzuki Grand Vitara, V6, Nice!**

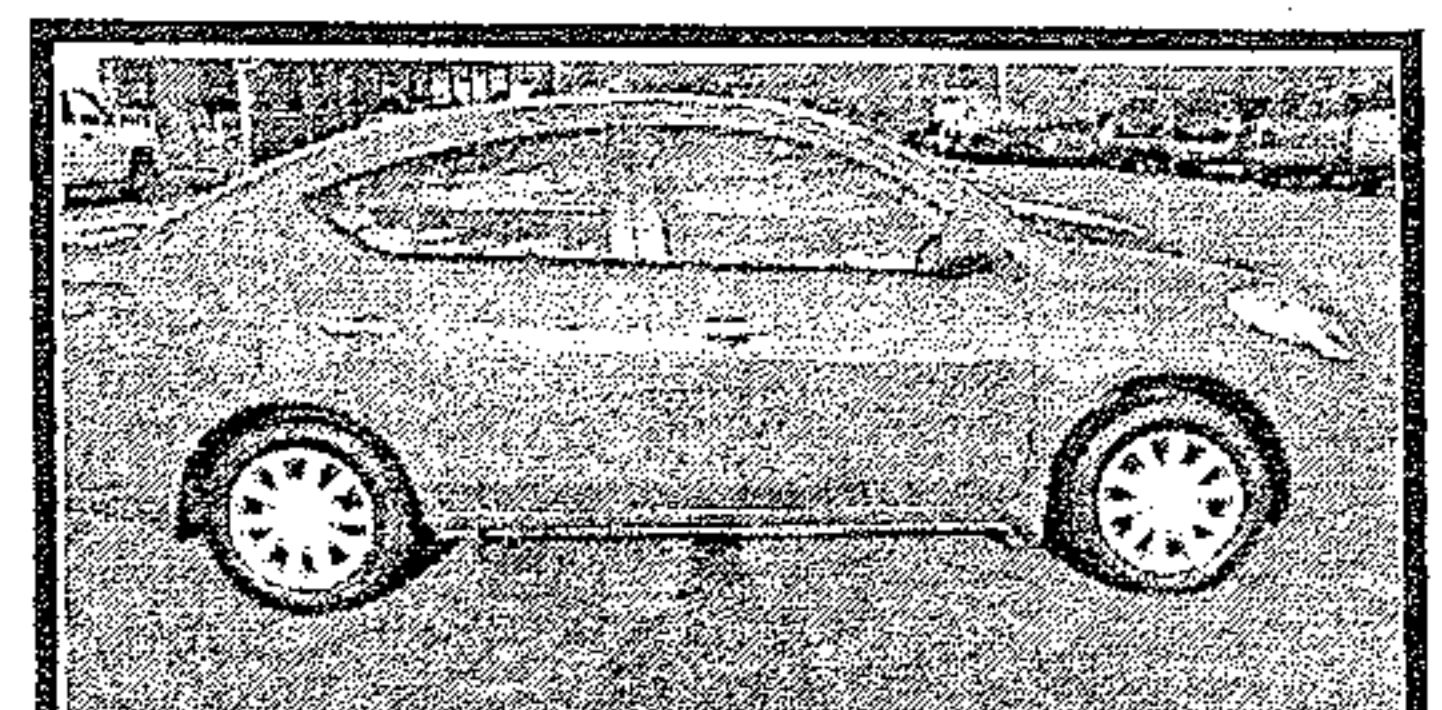

**2013 Nissan Versa, Like New! LOADED!!!**

**WALT WILLIAMS, INC.**

\*with approved credit

**3003 Highway 11 Lenoir City, TN 865-986-1111**