

The Daily Edition

50¢

Serving Loudon, Monroe and Surrounding Counties

Wednesday, October 28, 2015

Two charged after being found passed out in Loudon



Kassie Littleton



Traci Littleton

(see loudon pg. 7)

Loudon woman charged after victim hit in the eye



Kristi Stutts

(see domestic pg. 3)

All cranked up throwing stuff at cars

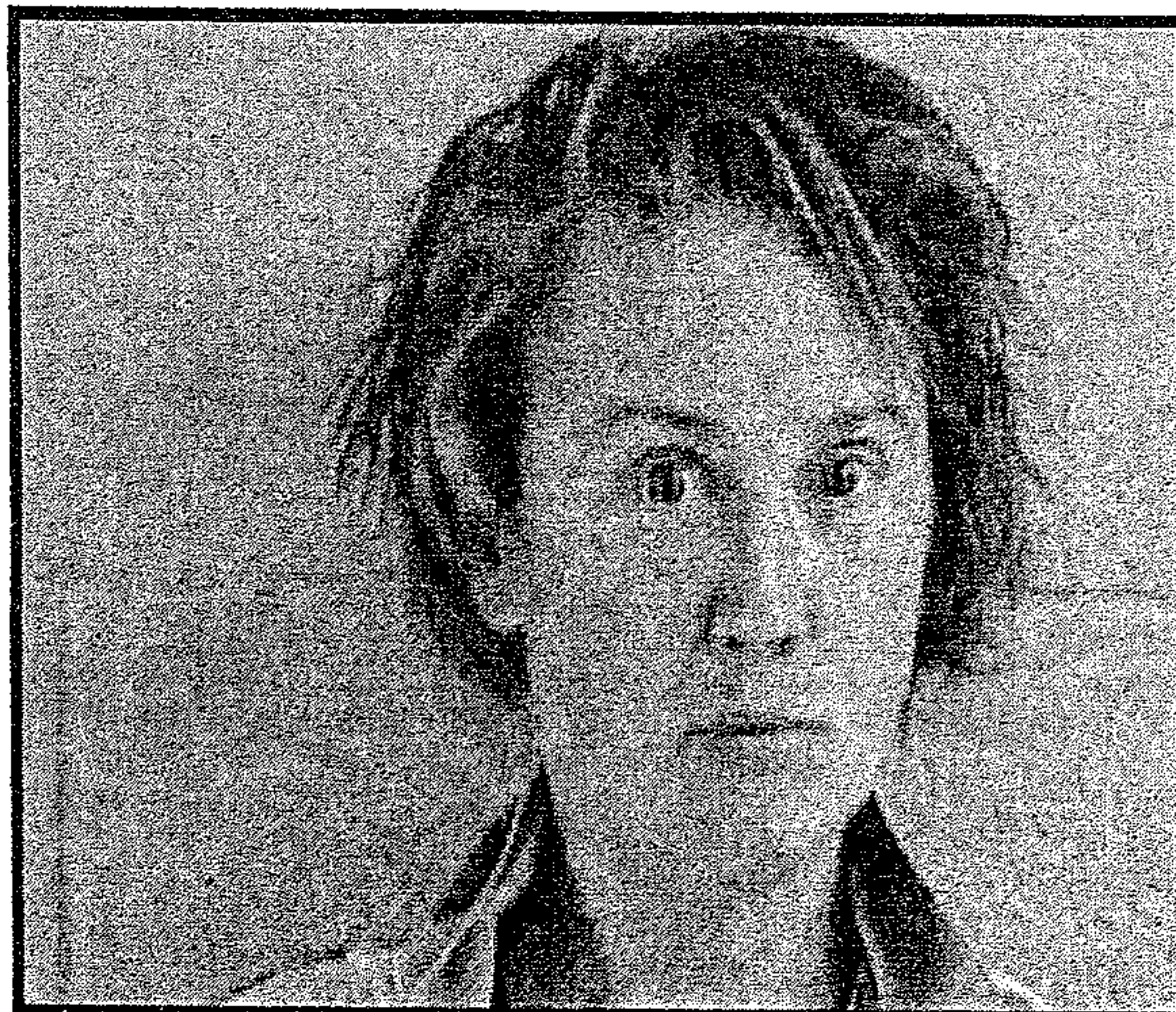

Amanda Steele

(see charged pg. 2)

Man charged after driving 110+ in THP traffic stop



Patrick Rowe

(see THP pg. 4)

Symposium Facilitates Exchange of Research on Lawful Interrogations

Event Sponsored by Government's High-Value Detainee Interrogation Group

"The rule of law in the Constitution is our spine, it's who we are, it's part of our fiber ... and we want humane, effective, lawful encounters with every human being."

Those words were spoken last week by FBI Director James Comey as he was discussing the efforts of the U.S. government's

High-Value Detainee Interrogation Group (HIG) during the HIG's fifth annual research symposium, held October 23 at the National Academy of Sciences in Washington, D.C.

Comey, who briefed symposium participants on the evolving terror threat, also said that the HIG's work "is valuable beyond national security cases" and that the group's research and

(see FBI pg. 5)

Verse of the Day

Wine is a mocker and beer a brawler; whoever is led astray by them is not wise. — Proverbs 20:1

Obituaries

see inside

Wazzup

A Big Shout Out to the crew at Wampler's, keep up the great work and sure do appreciate all the company does for the community as well!

Weather

Today: Rain early...then

remaining cloudy with showers in the afternoon. Thunder possible. High 69F.

Tonight: Cloudy skies early with showers later at night. Low 56F.

Thursday Some sun in the morning with increasing clouds during the afternoon. Slight chance of a

rain shower. High 68F. Thursday Night Partly cloudy skies. Slight chance of a rain shower Low 42F.

Horoscopes

Scorpio 10/23-11/21

You might believe that your interpersonal communication (Continued on page 6)



charged

Amanda Steele, 35, Head of the Creek Road Sweetwater, was charged with Simple Possession, and Poss. of Drug Para.

According to the report, Deputy Cody Fritts LCSO, was dispatched to Oakland Road on a disorderly female, who was talking out of her

head and throwing thing at passing cars.

Upon contact female was identified as Amanda Steele, who was talking really fast and saying random things.

Deputy ask Amanda if she had anything illegal on her and she handed Deputy a pack of cigarettes. Inside the pack was marijuana joint, aluminum foil with

burnt markings, and a straw. Amanda stated that she used meth/crank.

Amanda was placed under arrest.

Deputy Cody Fritts LCSO, made the arrest.

To Get a Burning Permit:

Loudon (865) 986-8395
 Monroe (423) 442-7401
 Roane (865) 354-1054

Notice: The Daily Edition does not knowingly accept fraudulent or misleading materials. The Daily Edition cannot guarantee the validity of offerings or statements contained herein. All liability for the contents of all advertising, and for any claims that may arise therefrom, is the responsibility of the advertiser or its agency. The Daily Edition reserves the right to reject, edit, or abbreviate any advertisement submitted. Advertising is accepted with the understanding that all liability for all copyright violations is the sole responsibility of the advertiser. Photographs, artwork and other copy submitted for publication is considered the sole property of the advertiser. The Daily Edition will make every effort but will not be liable for failure to publish and ad or for typographical and layout errors. All statements and information about highlights featured items, letters to the editor, herein are those solely given to the interviewer or writer and the Daily Edition assumes no responsibility of the accuracy or validity thereof. The Daily Edition will gladly reprint at no charge that part of an advertisement in which an error occurs provided a claim is made within 3 days of the first publication of the ad. Information contained in the Wazzup is received anonymously and the Daily Edition assumes no responsibility for information and reserves the right to edit or reject any and/or all submissions. The Daily Edition is a daily newspaper of general circulation in Loudon County defined under TCA 2-1-104(a)(13). The Daily Edition also serves Monroe, Knox, Anderson, Roane and Blount counties and serves 30,000 readers weekly. Send mail to PO Box 1240, Lenoir City TN 37771. 865-771-2249. email: dan1204us@yahoo.com
 The Daily Edition is Loudon County's premier public interest and paid advertising paper. The Daily Edition is produced and published daily Monday through Friday and is circulated throughout Loudon County and parts of Monroe and Knox Counties. Display advertising rates \$5.00 per column inch and quantity discounts available. Call for information on upcoming promotions and events.

HACIENDA Ayala's
Mexican Restaurant
 Market Dr. * Lenoir City (In Front of Food City)

Real Authentic Mexican Food at Affordable Prices

BEST MARGARITA

You've Tried The Rest
 Now Come Have The Best!!!

We Accept ALL Competitors Coupons Outside of Mexico City!!

986-3553



Good Credit OK • Bad Credit OK • Bankruptcies OK • Repo OK



2010 Kia Soul Sporty, 4 cyl, Auto, PW, PL, A/C, Great On Gas, Like New



2011 Chevy Malibu 2LT, Loaded, Heated Seats, Leather, PS, PW, PL, Chrome Package



2000 Chevy S10- 4 Cyl, Auto, 3 Door, A/C, Tow Pkg

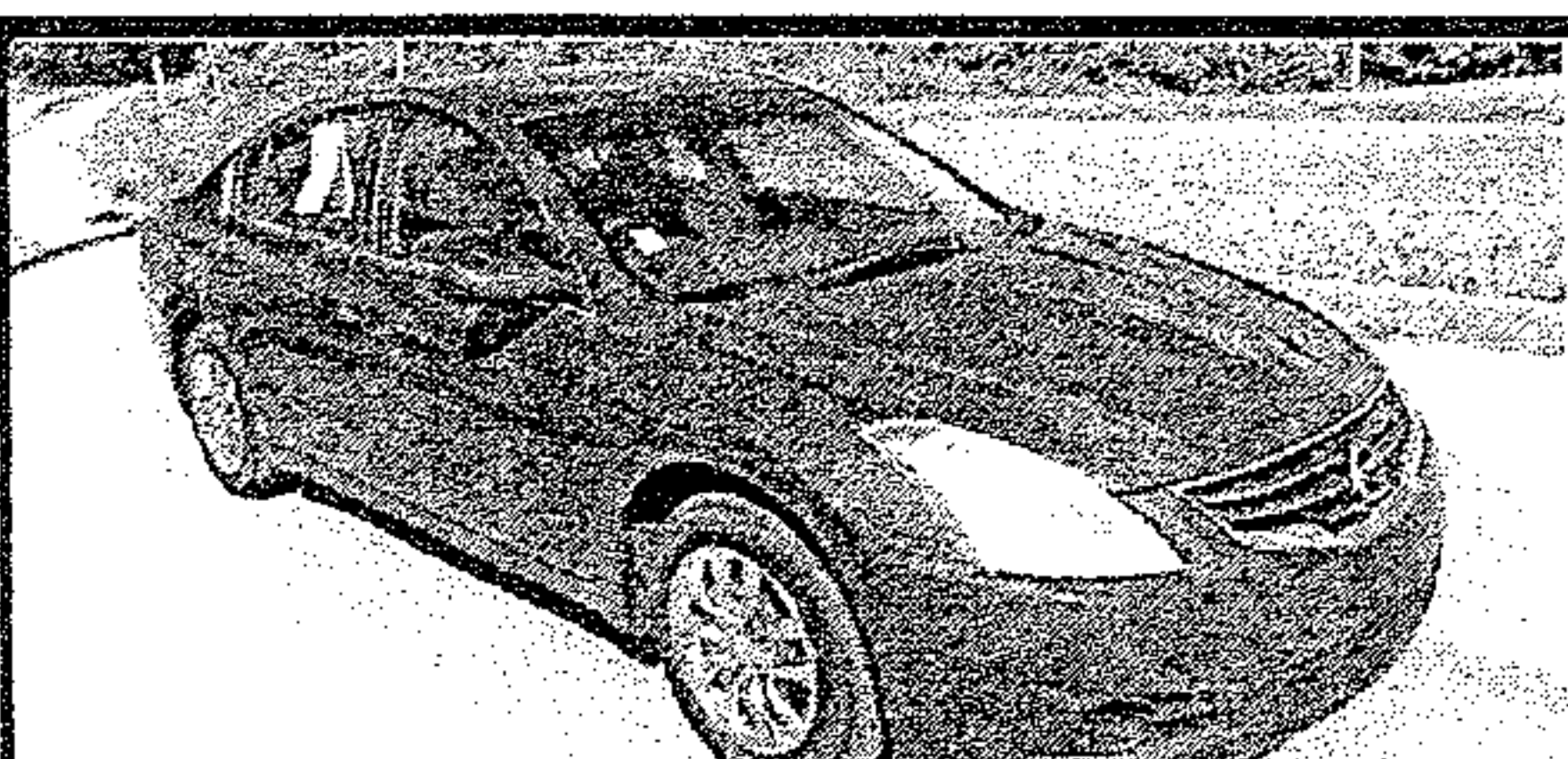

2010 Nissan Altima- GA\$ \$aver, Push Start, Chrome Wheels, PW, PL, A/C



2011 Hyundai Elantra- Leather, Sunroof, PW, PL, Immaculate Shape, LOW MILES 78K!!!



2013 Dodge Caravan SXT 86K, Power Doors, PW, PS, PL, Stow & Go

DEPENDABLE MOTORS 986-9343
803 E. Broadway • Lenoir City

Serving Loudon County for 20 Years

* WAC. See Dealer for details

Visit our website at: www.dependablemotorslc.com

domestic

Kristi Stutts, 21, Ferry Street Loudon, was charged with Domestic Assault. Officer Brandon Nix LPD, was dispatched to the Jiffy for a possible domestic. Upon arrival Officer made contact with the victim who stated he was staying at Ferry Street with his girlfriend Kristi Stutts. Victim stated that he ask Kristi if she wanted him to take his vehicle to the Inn of Lenoir where the couple had been staying. Victim stated Kristi started accusing him of wanting to leave her. Victim tried to leave and Kristi got in front of victim and shoved him in the chest area, then struck victim in the face with a closed fist. Officer did observe a bruise on victim right eye. Kristi was placed under arrest. Officer Brandon Nix LPD, made the arrest.

Obituaries

James Richard Elam, age 77 of Lenoir City, TN passed away on October 24, 2015 after a violent fight with cancer. He was a member of Pleasant Hill Baptist Church. Surviving is his wife of 58 years, Pearl Kincer Elam of

the home; two sons, Sydney Ray Elam and wife Tammy of Lenoir City, TN, and Stanley Jay Elam and wife Teresa of Williamsburg, VA; daughter Vanessa Elam Paris and husband Michael of Lenoir City, TN; two Grandchildren, Richard James Paris and wife Elitsa and Madison Rae Elam. In addition to his parents, he was preceded in death by his grandson Christopher Ray Paris. The Family will receive friends from 5 to 7 pm with funeral services to follow at 7 pm on Tuesday, October 27 at Click Funeral Home in Lenoir City, TN. Family and friends will gather at 11 am Wednesday at the Pleasant Hill Cemetery for graveside services. In lieu of flowers, memorial

contributions may be made to the Pleasant Hill Cemetery Fund.

Freddy L. Ward- 59, born June 29, 1956 passed away October 23, 2015 at the age of 59. Freddy lived his life with joy, kindness, unconditional love, was able to forgive all hurts, had a strong will to live, and could not wait to start each day happily. He loved meeting people, "flirting with

the girls", doing his impersonations of his favorite famous people. He loved Sci-Fi Movies, "Lost in Space T.V. Series", Wrestling, Elvis, W.C. Fields, going to ACT workshop "till he retired" Freddy had a full life everyone who met him, left with a smile and good feeling. Freddy was preceded in death by; precious Mother, Julia Ward Sane,

(see obits ctd. pg. 7)

West End Storage & Warehouses
502 Ward Avenue • Loudon
Call 865-458-4774 or 865-679-5555

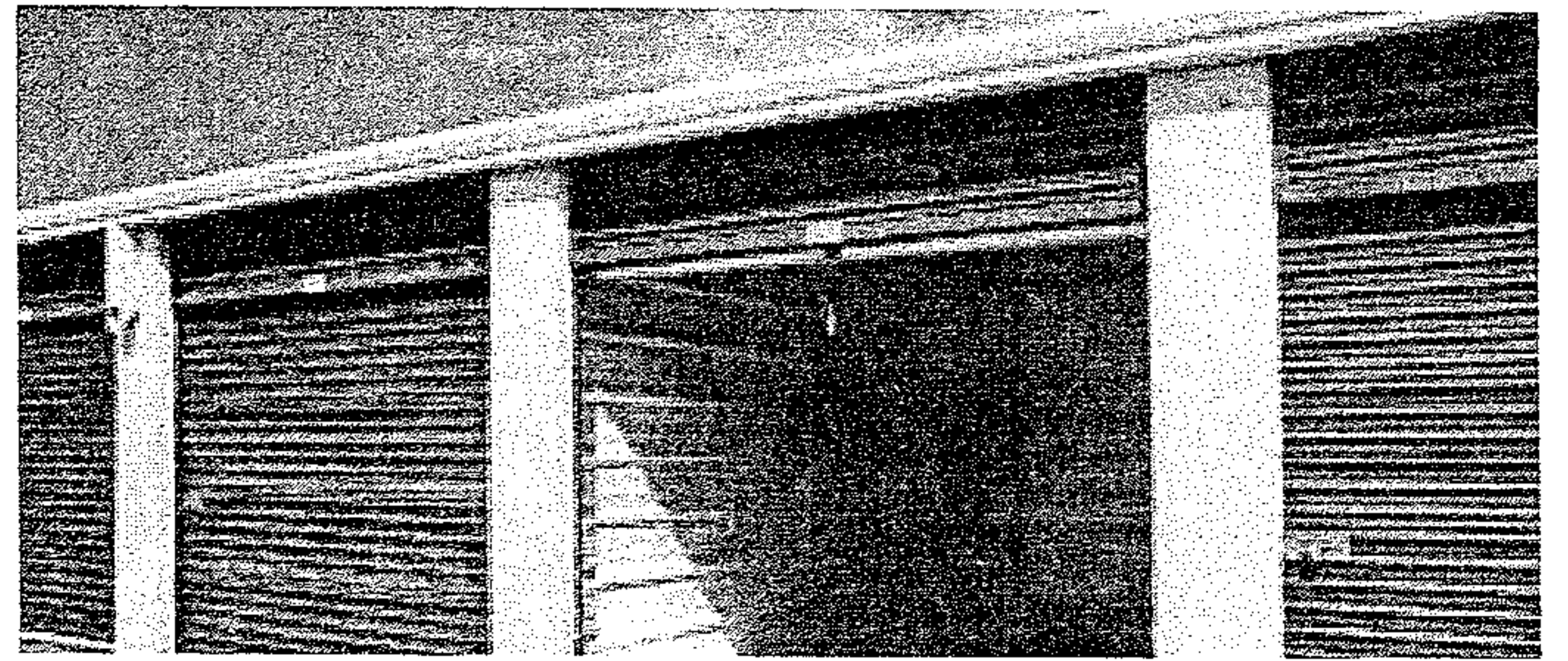

For Sale: oak Wood Mulch



Mushroom Compost Topsoil.



Firewood

Call Steve Spoon 986-4282

C&J Towing and Recovery

LOWEST TOWING RATES AROUND!!!

Have you been overcharged for any type of towing service in the Lenoir City area? If you have a breakdown or accident please OWNER REQUEST C&J Towing with the officer. Also please call your Sheriff and ask him to place C&J Towing on the "Rotation List*" and help other motorists save as much as you did! We at C&J are locally owned and operated, State approved, licensed, bonded and insured.

*note: the "Rotation List" is a list of wrecker services that provide service for wrecks, DUI's, breakdowns, etc. and are on an on-call basis for service. This list is approved by the Sheriff.

Cliff Teeters • Owner
 865-809-1661

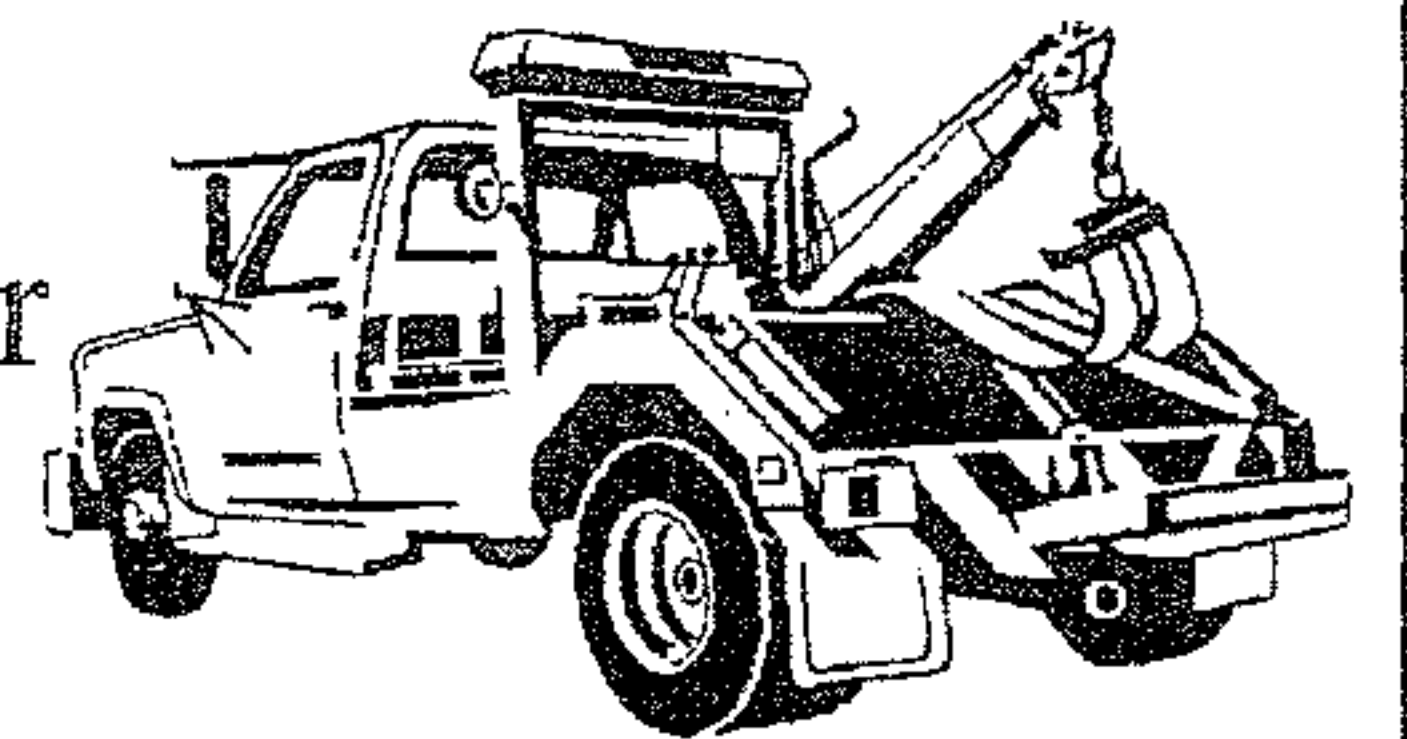

BIMBO'S
Deli Open 24 Hours
865-986-9643 Call Ins Welcome
Specials
Lg. Cold Sub, bag of chips and 16 oz. fountain drink only \$6.29
Footlong Corn Dog \$2.59

THP

Patrick Rowe, 32, Old Springs Road Maynardville, was charged with Reckless Driving, Simple Possession, Driving on Revoked/Suspended License, and Poss. of Drug Para.

Trooper James Capps THP, was traveling West on Interstate 40 around the 369 mm, when he observed a vehicle driving recklessly. The driver identified as Patrick Rowe was weaving in and out of traffic without signaling. Trooper paced the vehicle traveling

at 110 mph and the vehicle was still pulling away from trooper. Trooper activated his emergency lights and siren where the vehicle pulled over on the shoulder immediately. Upon contact with the driver Patrick Trooper could smell a strong odor of marijuana coming from the vehicle. Trooper recovered a marijuana cigarette and a marijuana smoking pipe. Dispatch advised Patrick's license were revoked. Patrick was placed under arrest. Trooper James Capps THP, made the arrest.

Loudon County Sheriff's Office Toys for Tots 2015

Thanks to the generosity year after year of the Loudon County residents, churches, businesses and industries, the Loudon County Sheriff's Office is once again able to offer the Toys for Tots program. We are beginning our 31st year of providing toys to the needy children of Loudon County, and thanks to generous contributions of time, money and gifts, we are able to make Christmas a more joyful time for more and more children. In 2014, approximately 500 children were helped by the Loudon

County Sheriff's Department Toys for Tots program through their partners. Even with the difficult economic times we are experiencing, we hope that the people of Loudon County will be there once again to help.

Names will be available beginning in mid-October through business and churches. If you are considering helping a child this

Christmas, please be assured that applicants are thoroughly checked to make sure they require this assistance. Names are also compared with the school systems to make sure no one is receiving duplicate assistance.

If your business or church would be willing to take names please call Debbie Hines, Toys for Tots Coordinator at 986-4823.

Purdy's Auto Sales
Hwy 11 Sweetwater
Buy Here Pay Here
Cars, Trucks, Vans, SUVs

SARCO Enterprises Inc. Offers Complete Home and Commercial Remolding and Repairs

Our Team members have a combined total of over 40 years experience in all areas of home construction, facilities maintenance and commercial construction. Roofing, Electrical, Bath and Kitchen Renovations, we do it all with just one call. We are fully insured and our work is guaranteed.

Call us today for a free no obligation quote for your next project.
 865-809-9492.



SOUTHERN AUTO DETAILING
414 WEST BROADWAY
LENOIR CITY, TN 37771
865-986-0724

Starting at \$34.95
 Present this ad for \$5.00 off

Lenoir City Utilities Board
Gas Department

Pilot Lighting Season 2015

"Pilot Lighting Season" opens on October 1, 2015. The cost for lighting a pilot light will be as follows:

1st Pilot Lighting, during normal work hours
No Charge

Pilot Re-lights, during normal work hours
\$25.00

After normal work hours/Holidays pilot lighting
\$141.56

Please call 986-6591, ext. 1720, to make an appointment for this service.

LCUB normal work hours are Monday – Friday, 7:00 am – 3:30 pm.

FBI

training efforts benefit law enforcement interviewers as well.

The HIG, established in 2009, brings together personnel from the U.S. Intelligence Community to conduct interrogations that strengthen national security and that are consistent with the rule of law. But in addition to its operational role in eliciting accurate and actionable intelligence from high-value terror-

ism subjects, the HIG plays another vital role as well—serving as the government’s focal point for interrogation best practices, training, and scientific research. And during its yearly research symposium—coordinated by the Center for Law & Human Behavior at the University of Texas at El Paso—scientists from the U.S. and abroad who work with the HIG have the opportunity to share with policy makers and intelligence professionals

ground-breaking research that can impact the effectiveness of interview and interrogation methods.

All HIG-sponsored research is unclassified—researchers who work with the HIG are free to publish their findings, and most do. At this year’s symposium, participants presented research on topics like the dynamic nature of interrogations, the challenges of interviewing through interpreters, the use of rapport rather than tough tactics, negotiations

across cultures, subtle elicitation approaches, and priming disclosure and cooperation.

Background on the HIG. The director of the HIG is an FBI representative and is assisted by two deputies—one from the Department of Defense and the other from the Central Intelligence Agency. Full-time HIG members are augmented part-time by HIG-trained professionals from FBI field offices and other U.S. Intelligence Com-

munity agencies.

HIG responsibilities fall under three primary areas, all of which feed into one another:

Interrogations: The HIG deploys expert Mobile Interrogation Teams (MITs) to collect intelligence that will prevent terrorist attacks and protect national security. Since the HIG’s creation, MITs have been deployed within the U.S. and abroad. Deployment teams generally consist of a team leader, interrogators, analysts, subject matter experts, linguists, and other personnel as needed. HIG interrogators are chosen for—among other attributes—their extensive interviewing and interrogation experience and their willingness to adapt to evolving interrogation techniques based on the latest scientific research.

Research: The goal of the HIG’s research program is to study the effectiveness of interrogation approaches and techniques by identifying and validating existing techniques that work—and by developing new lawful techniques that may work even better. The HIG identifies research gaps in the interrogations field and commissions research products to fill in these gaps. To carry out the research, the HIG contracts with Ph.D.-level scientists from all over the world known for their expertise in interrogations and other related fields. Since its founding, the HIG has funded nearly (see FBI ctd. pg. 8)

PURDY'S AUTO PARTS AND SALVAGE
WE BUY SCRAP IRON • COPPER • BRASS • ALUMINUM

\$ **Paying Top \$\$\$**
Call For Latest Prices

You Name It, We Buy It!

Radiators, Wheels, Batteries, Appliances, Farm Equipment

Complete Cars
per 100 lbs.

Scrap Metal
Paying Top \$\$\$
Call For Latest Prices
per 100 lb

Copper
Paying Top \$\$\$
Call For Latest Prices

We Buy Batteries

Aluminum Cans
Paying Top \$\$\$
Call For Latest Prices

You Call We Haul!
423-519-5402



Now Selling
Aftermarket
Body Parts at
Discount Prices

Prices subject to change with the market.

423 337-3977
149 County Road 323 Sweetwater

Prices subject to change with the market.

Wanted
Looking for a person interested in covering events in and around Loudon County. Must have license, own transportation, a computer or equivalent and can write. Call Dan at 771-2249 to set up an interview.

loudon

Traci Littleton, 21, Jim Hartsook Drive Lenoir City, was charged with DUI by Consent.

Kassie Littleton, 33, Simpson Road Loudon, was charged with DUI, Legend Drug, Poss. of SCH. IV, and Simple Possession.

Trooper Rodney Best THP, responded to a call that came across the county radio of two females that appeared

to be asleep in a vehicle at 72 market. Upon Trooper arrival Deputy Kevin Dailey LCSO, had just arrived on scene and observed the driver holding a soda in one hand and a bag containing 2 hamburgers in her lap, and was slumped over toward the center console. The passenger was slumped over toward the center console as well. Deputy Dailey was able to wake the driver and

Deputy turned the vehicle off and removed the keys. While Trooper was speaking with the driver identified as Kassie Littleton he observed her to be disoriented and had slurred speech. Deputy tried to awake the passenger identified as Traci Littleton and could not get her to stay awake and called for EMS to respond. Deputy ask Tracie if she had taken anything and she stated no. As Kassie was being patted down Deputy found what appeared to be a bottle of prescription cough syrup. A search of the vehicle revealed several different bottles of pills belong to other people and two marijuana roaches. Both

were placed under arrest. Trooper Rodney Best THP, made the arrest.

Obits ctd. from pg. 3

step-Father, Lester Sane, sister, Katherine Ward Lankford, brothers, William A. Ward & Betty Ward, Herbert Ward, Jack Ward. Survivors. Brother, Clarence Jr. Ward, of Loudon, sisters, Helen Ward Stevens of Lenoir City, Violet Ward Arden of Loudon. Freddy and I lived together and "took care of each other" until his last stop in Heaven where he was met by, Jesus, Mother, and all Heavenly family. Freddy was dearly loved and it was a blessing to care for

him in our family. We learned may life lessons with him and from him. He always forgave easily, Loved Deeply, especially nephews, Ricky and Bruce and families, Jason, Britany and Val and Boys, and Lisa Galloway and Justin Shipman became lifelong friends as they helped me care for Freddy as Aides. Family and friends will meet at 1 P.M. Sunday October 25, 2015 at Pleasant Hill Baptist Church Cemetery 2166 Old Highway 95 Lenoir City for graveside services and Interment. Loudon Funeral Home in Charge of the Arrangements. www.loudonfuneralhome.net

Public Notice

The County Corrections Partnership Committee will hold an open meeting at the Justice Center training room November 4, 2015 at 12 PM to discuss plans to move forward

LOOK! \$75 Weekly Payments LOOK!

MARTY'S AUTO SALES • 986-2222 • MARTY'S AUTO SALES • 986-2222 • MARTY'S AUTO SALES • 986-2222 • MARTY'S AUTO SALES • 986-2222 • MARTY'S AUTO SALES •

Bad Credit
Divorce
Fixed Income
Repos
Bankruptcy
No Credit



APPROVED!

Visit Us On The Web At:
martysautosales.net

NO CREDIT CHECKS



\$499 down*

07 Cobalt, 5spd, gas saver, runs great Only \$499 down *

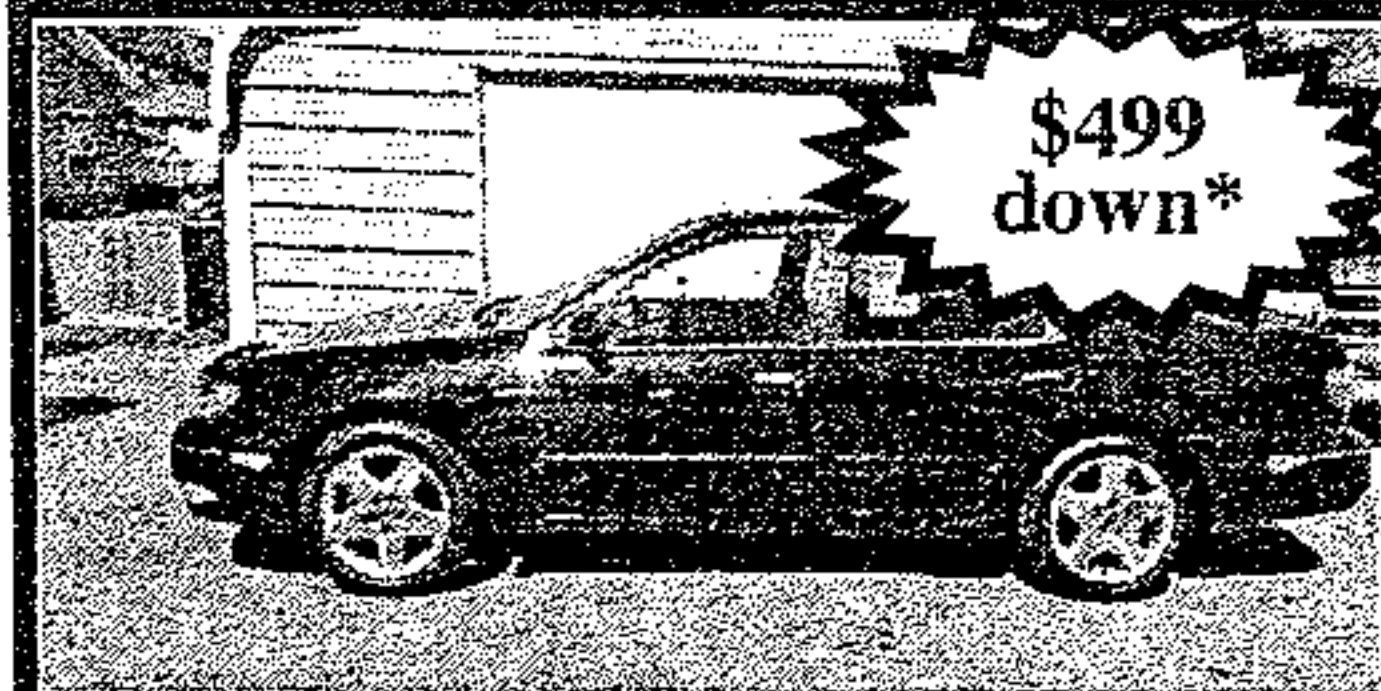

\$499 down*

00 Focus, Loaded, Lthr, Sunroof Only \$499 down *

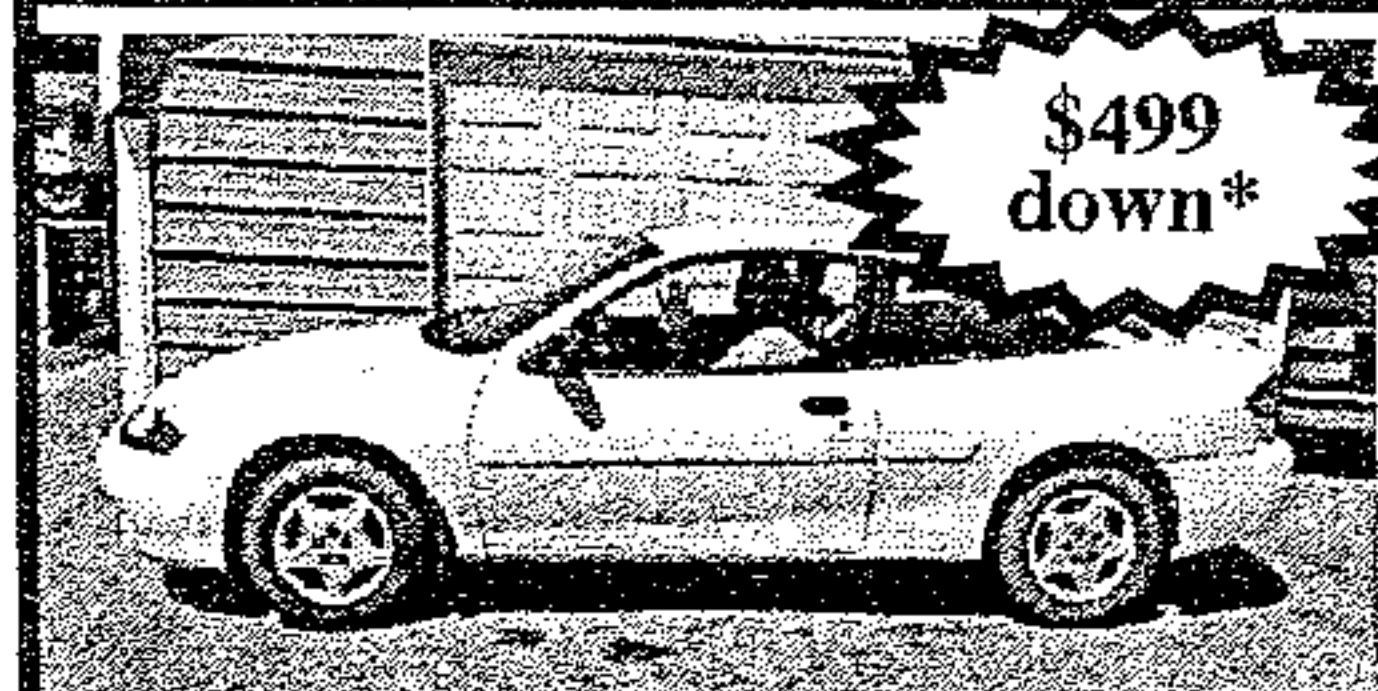

\$499 down*

04 Cavalier, 2dr, Sporty, Only \$499 down *

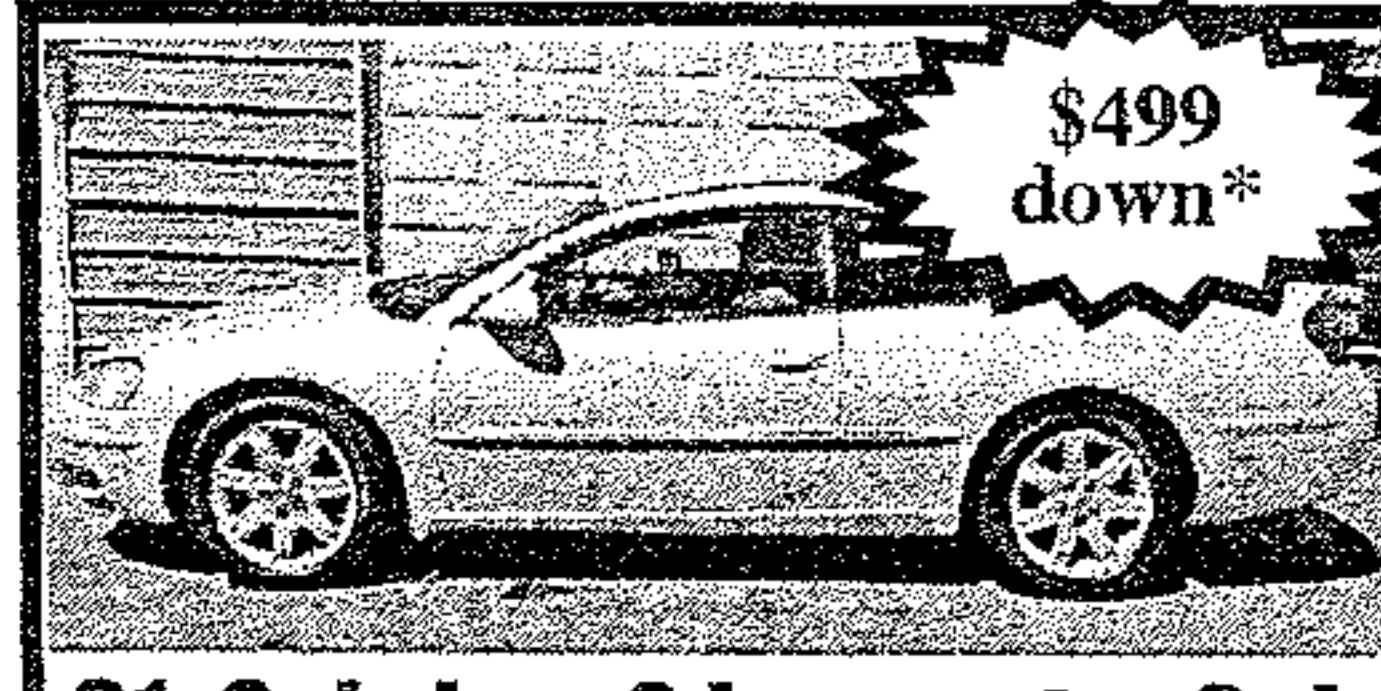

\$499 down*

01 Sebring 2dr. sporty, Only \$499 down *

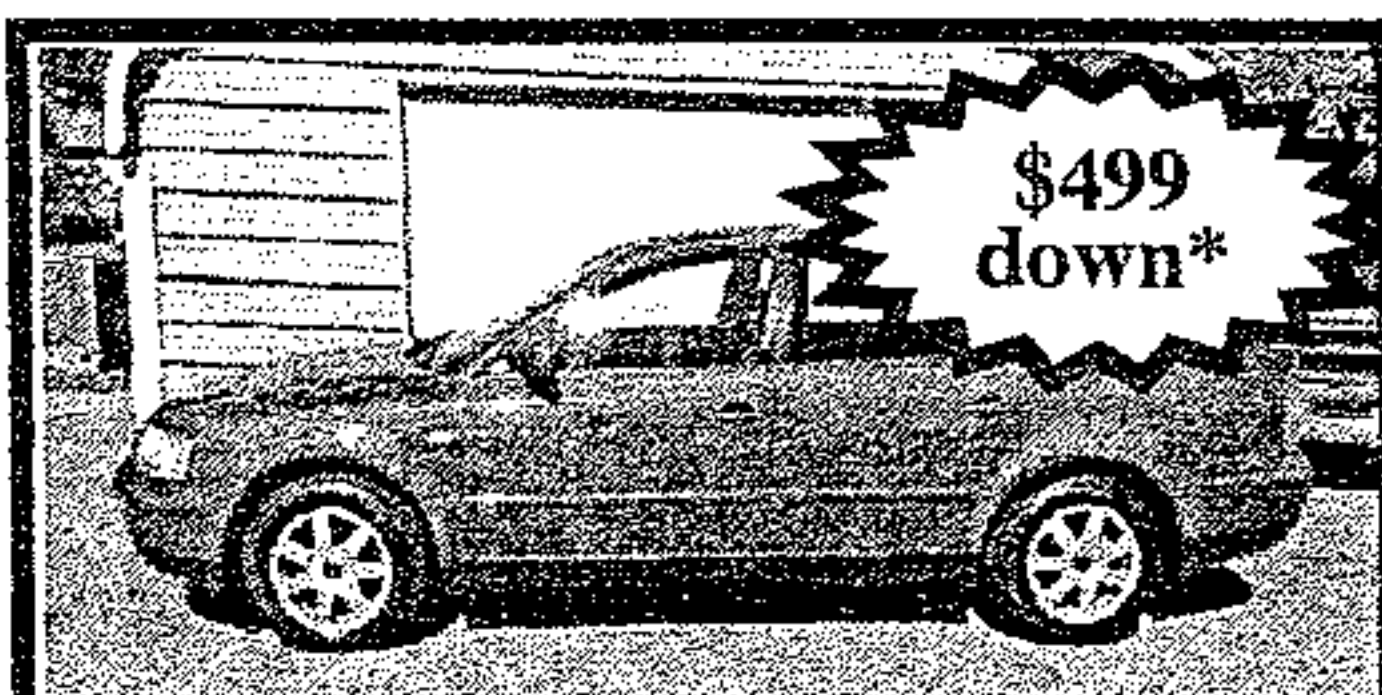

\$499 down*

01 Passat, Turbo, 5 speed Only \$499 down *



\$499 down*

03 Focus 5 speed, Gas Saver Only \$499 down *



\$499 down*

04 Optima, Runs Great LX V6, Only \$499 down *



\$499 down*

00 Ram, High Top Conversion Van, Loaded only \$499 down *

NO Credit Checks

Marty's Auto Sales
986-2222

Se Habla Espanol

100% Approval*

*See Dealer for details. All down payments plus tax, tag, title and fees.

MARTY'S AUTO SALES • 986-2222 • MARTY'S AUTO SALES • 986-2222 • MARTY'S AUTO SALES • 986-2222 • MARTY'S AUTO SALES • 986-2222 • MARTY'S AUTO SALES •

FBI ctd. from pg. 5

80 interrogation research projects, some of which have covered interviews with expert interrogations interrogators, social influence tactics, the impact of interpreters, the cognitive interview, the strategic use of evidence, and science-based methods of detecting deception. A side note: All HIG research is done in complete compliance with international laws and U.S. laws concerning the protection of human research subjects.

Training: The HIG works to develop and disseminate best practices for training purposes for its own interrogators and part-time personnel and for other U.S. Intelligence Community and law enforcement partners and allies abroad. Over the past year, HIG trainers—who are FBI-certified training instructors—have worked with more than 500 students from multiple agencies, including 90 foreign partner participants.

And some of the HIG's interrogation techniques have been added to the curricula of the Department of Defense's human intelligence training facility in Arizona and the Federal Law Enforcement Training Centers in Georgia, among others. HIG interrogations are primarily terrorism-related, but the lawful interrogation techniques can also be used when questioning criminal suspects, which is why we share best practices with and conduct training sessions for select state and local law enforcement partners.

Has the HIG been effective? According to HIG Director Frazier Thompson, "Much of our operational work is necessarily classified, but I can tell you this—as a result of the HIG, plots to harm the U.S. and its allies have been disrupted, dangerous people have been put behind bars, and gaps in U.S. intelligence collection have been bridged."

A Name You Already Know And Trust Just Got Even More Dependable
DEPENDABLE AUTO SERVICE, LUBE AND TIRES
is Now Offering
Expert, Affordable Transmission Service

All ASE Certified Technicians

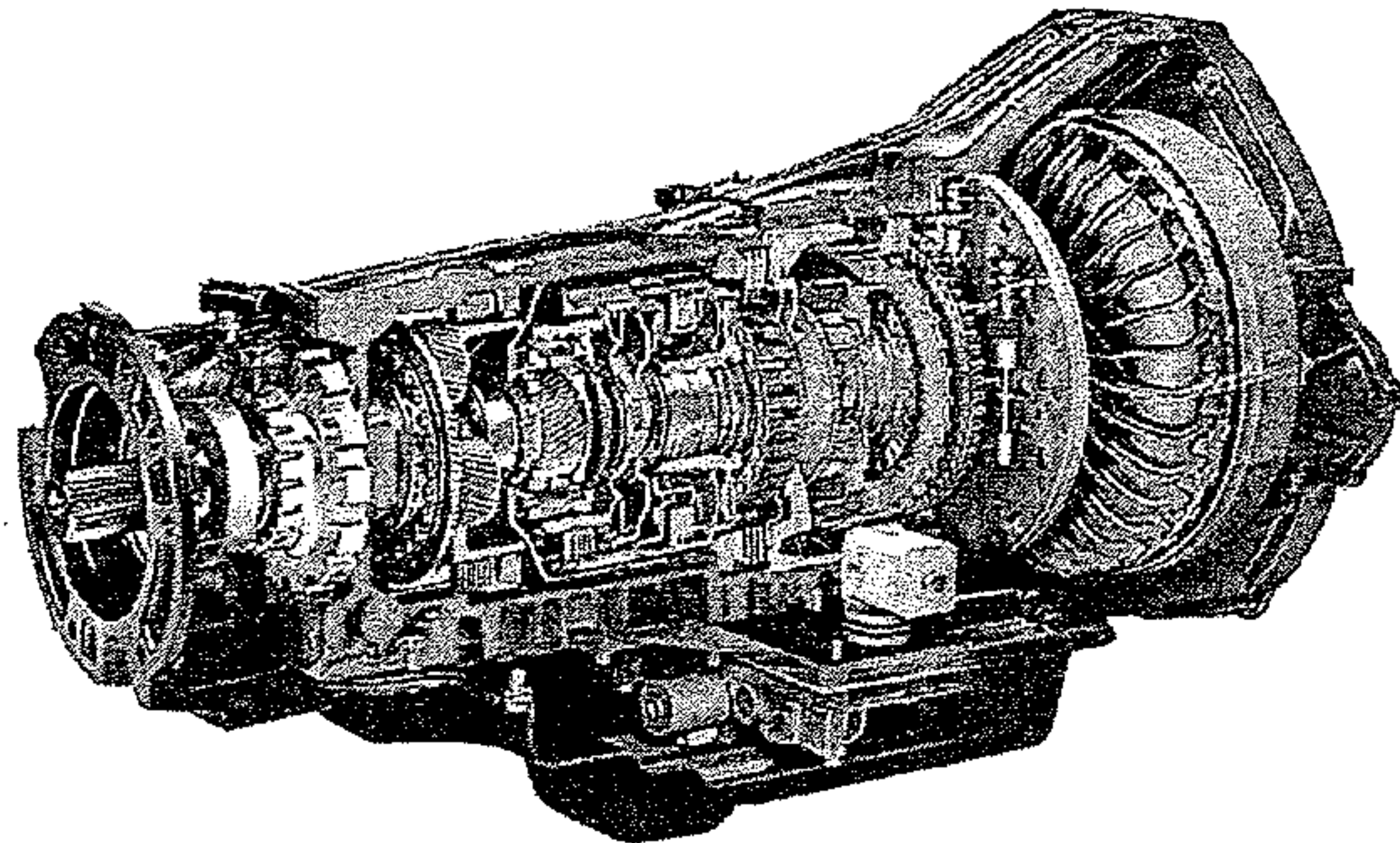

We proudly welcome all New Customers and Former Advanced Transmission Customers with a 10% Discount and Any Transmission Service or Repair*

865-986-9359

865-986-5050

Bad Credit, No Credit OK!!! We Finance Everybody!!!

Low Down Payment!!!

Over 100 Cars, Trucks & Vans in Stock - Warranties On ALL Vehicles Sold!!!

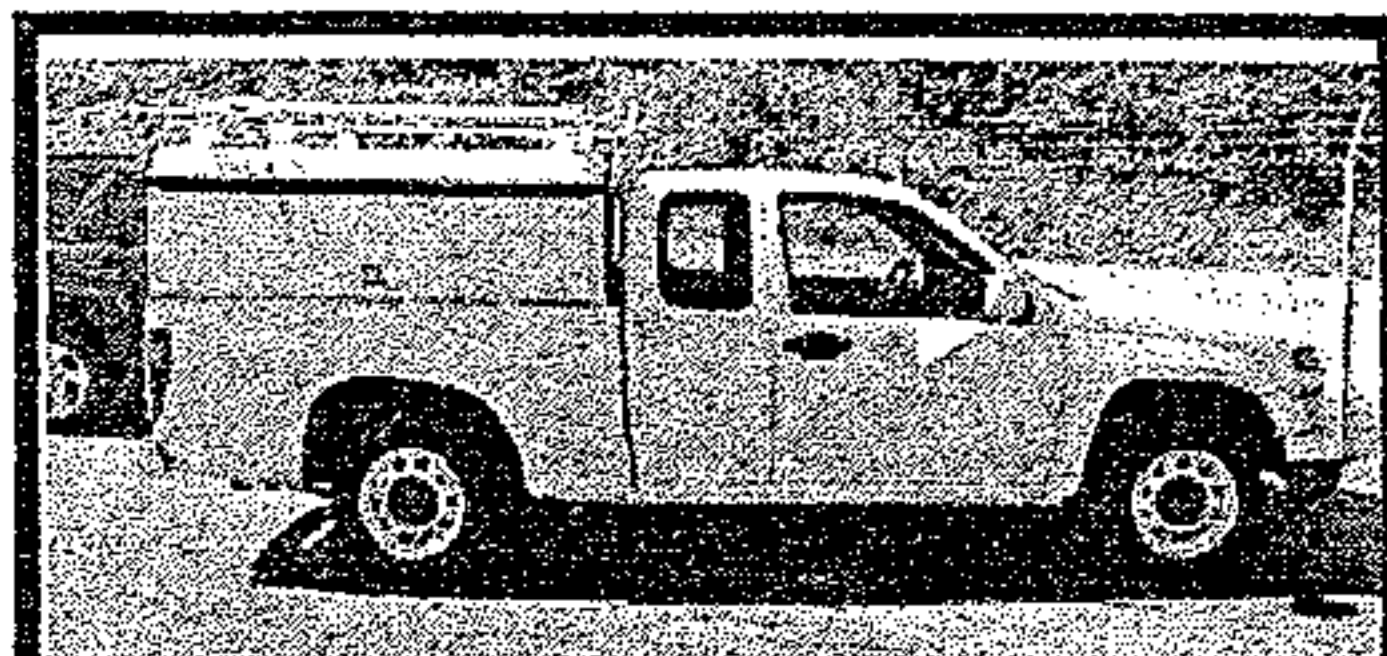

2009 Chevy Work Truck, Nice, lots of storage



2009 Nissan Cube, 66k miles, Great Gas Saver,



2006 Renault, 128k miles, leather, 3rd row seat

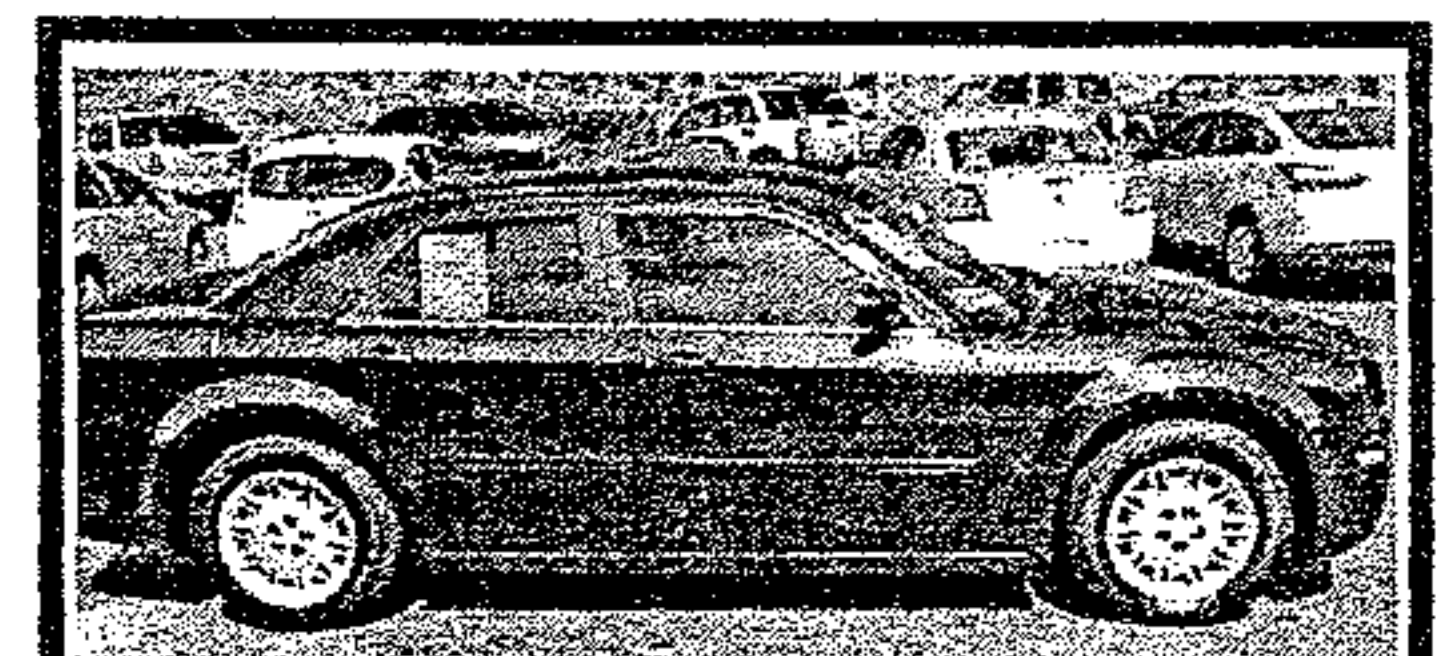

2006 Chrysler 300, Loaded, Nice Ride



2005 Dodge Dakota, 4dr, 4x4, Extra Clean, lots of room



2011 Chevrolet Cruze, 55k miles, LOADED!!!



2003 Chevy Trailblazer, 93k miles, Extra Clean



2006 GMC 1500 Ex. Cab, 101k miles, Clean ride

WALT WILLIAMS, INC.

*with approved credit

3003 Highway 11 Lenoir City, TN 865-986-1111