

The Daily Edition

50¢

Serving Loudon, Monroe and Surrounding Counties

Monday, October 26, 2015

Big Bust for LCSO in routine traffic stop around known drug area

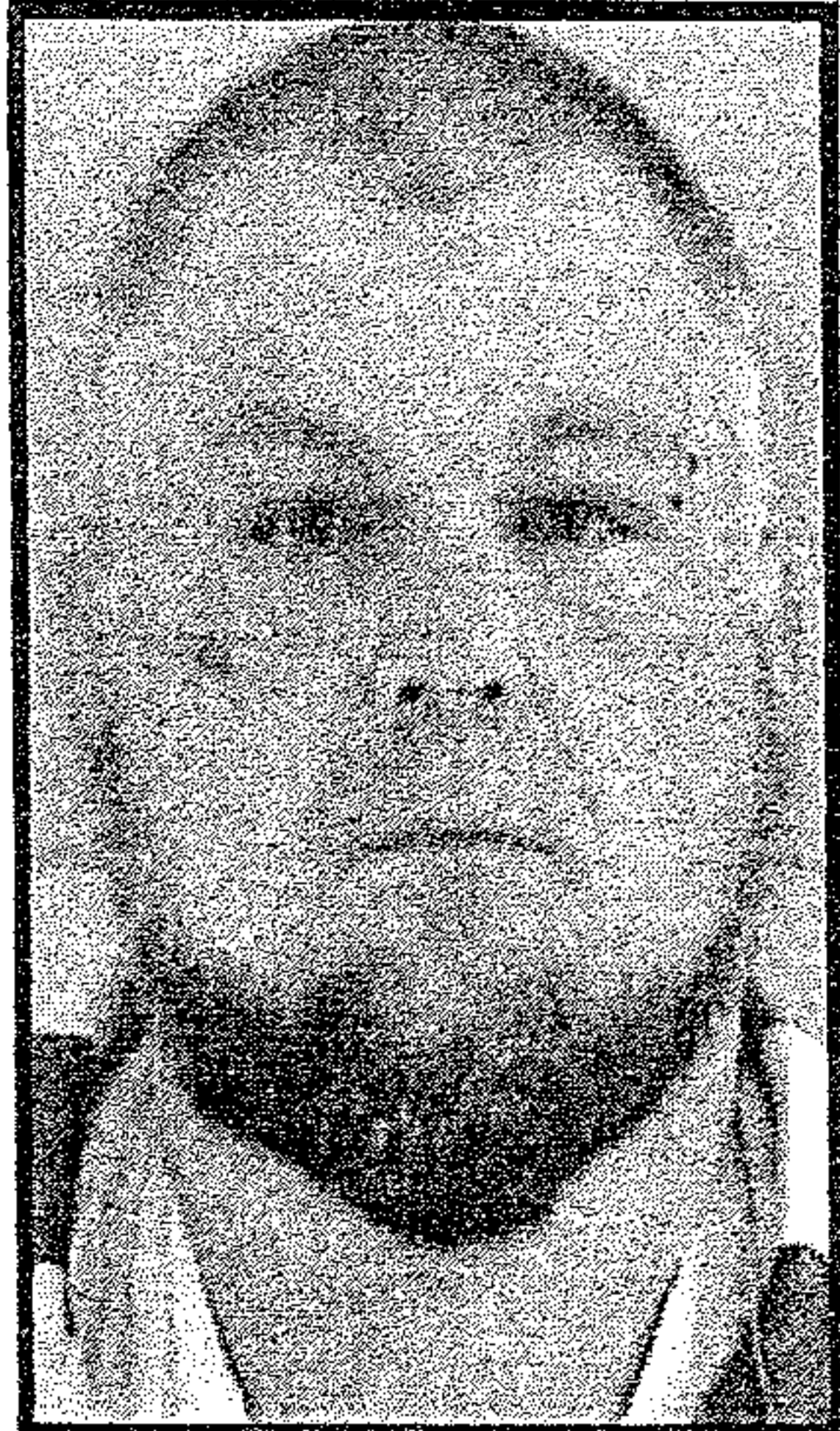

Christopher Carroll

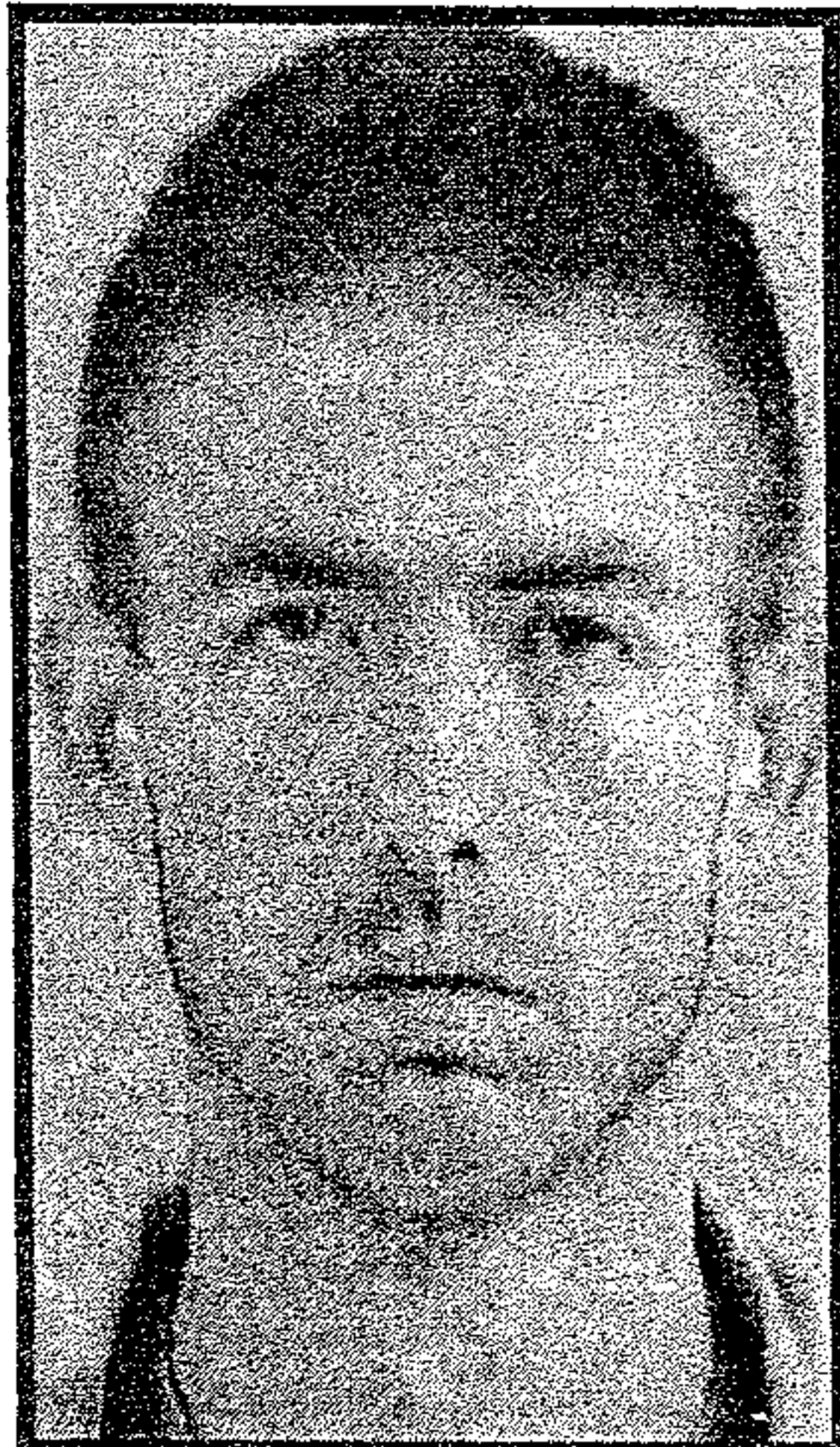

Dennis Clark



Jennifer Wilson

(see bust pg. 7)

Mark Douglas Helton pleads guilty to child pornography offenses
On Oct. 20, 2015, Mark Douglas Helton, 61, of Maryville, Tenn., pleaded guilty in U.S. District Court for the Eastern District of Tennessee, to knowingly distributing and receiving child pornography. Sentencing has been set for 2:00 p.m., March 9, 2016. Helton faces a maximum of up to life in prison, as well as supervised release following guilty plea.
(see guilty pg. 3)

Male/female victim escapes serious injury thanks to LCSO

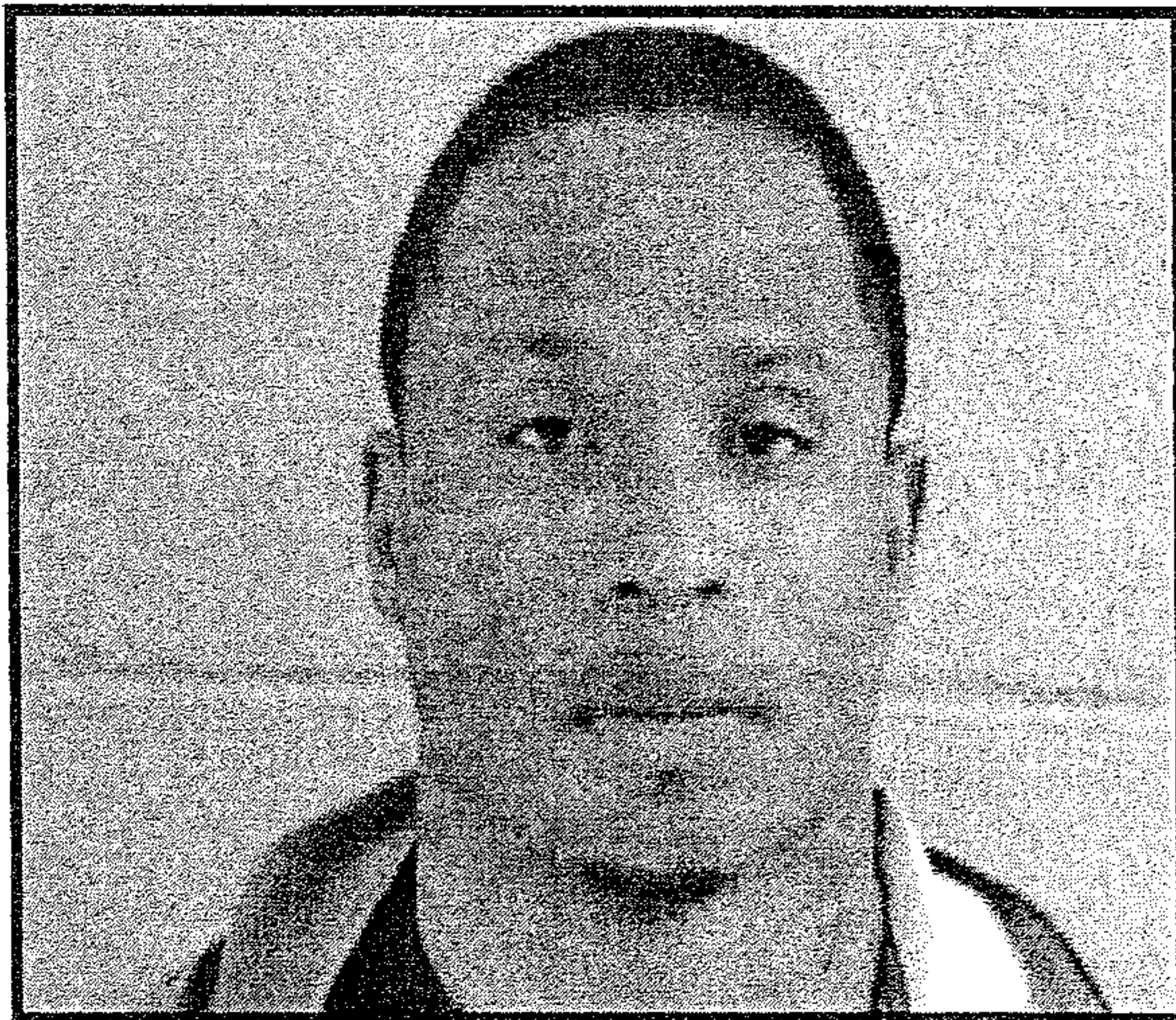

Jimmy Upshaw

(see LCSO pg. 2)

2 charged with reckless endangerment after shooting in the village

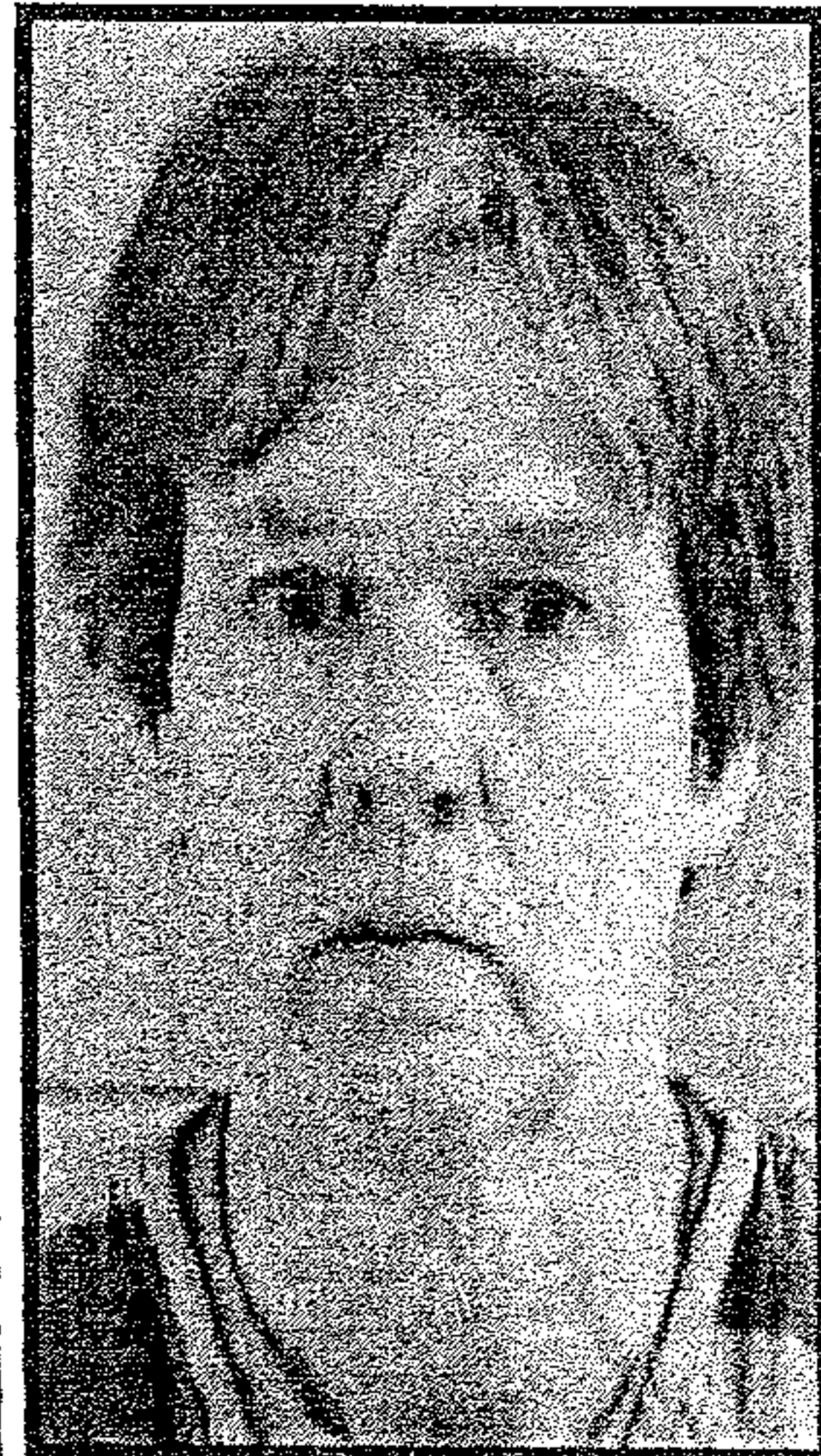

Frank Bristow

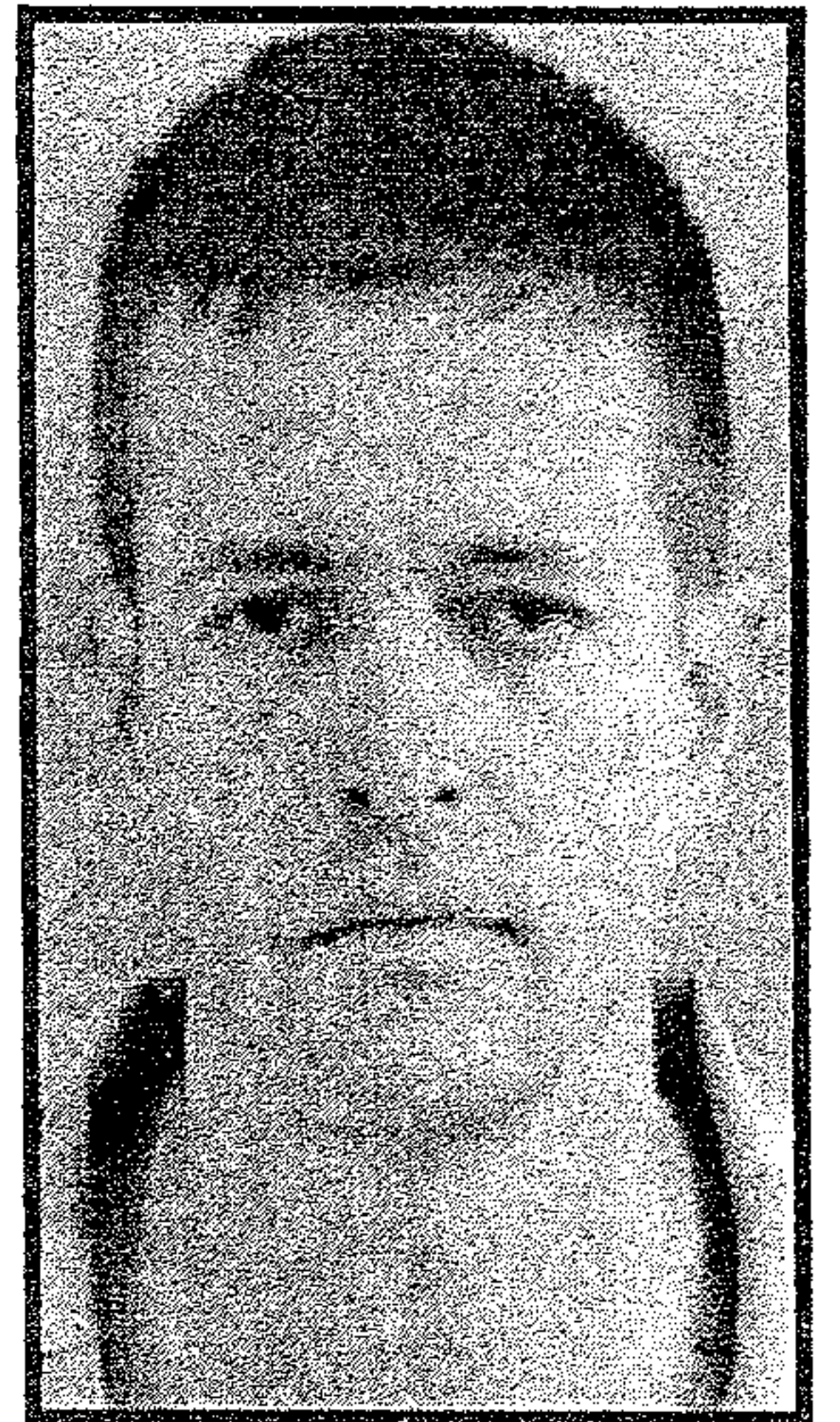

Kevin Fann

(see shooting pg. 4)

Customer Appreciation Day at Wilburn's



photo from left Ed Shipley, owner of Wilburn's, Joseph Wallace and Mike Cartwright enjoy some good food and good times at Wilburn's Customer Appreciation Day this past Thursday.

(see Wilburn's pg. 5)

Verse of the Day

"Ever since the time of your forefathers you have turned away from my decrees and have not kept them. Return to me, and I will return to you," says the LORD Almighty. — Malachi 3:7

Obituaries

see inside **Wazzup**

It's Trick or Treat Week in Loudon County and it looks like everybody is having a fall festival, trunk or treat, or some cool activity going on

so make sure you get the vans and pickups ready for the weekend!

Weather

Today: Showers in the morning, then cloudy in the afternoon. High near 70F.
Tonight: Partly cloudy skies early will become

overcast later during the night. Low 57F.

Tuesday Considerable cloudiness with occasional rain showers. High 66F.

Tuesday Night Showers early, becoming a steady rain late. Low near 55F.

(Continued on page 6)



LCSO

Jimmy Upshaw, 27, Arthur Langford Atlanta, was charged with Domestic Assault.

Deputy Kevin Parks LCSO, was dispatched to a disturbance at Pond Creek Rd (Simmons BP) in reference to a disturbance. Before Deputy could arrive on scene the complainant at Simmons

BP said the subjects were leaving in a new model Red Chevrolet with a drive out tag going Northbound.

Loudon County Deputies made contact with this vehicle on Interstate 75 Northbound around the 78 MM. Upon talking to the male driver (who appeared female) said that he and Jimmy L. Upshaw were traveling

on I-75 North and began to argue about the music in the car. Victim said he pulled the car over to the gas station and went to the restroom where Mr. Upshaw followed him into the restroom. while

the restroom victim said Mr. Upshaw began to shove and choke him, and tell him he was going to kill him. Victim said he told me he was going to kill him and beat him

(see LCSO ctd. pg. 3)

Notice: The Daily Edition does not knowingly accept fraudulent or misleading materials. The Daily Edition cannot guarantee the validity of offerings or statements contained herein. All liability for the contents of all advertising, and for any claims that may arise therefrom, is the responsibility of the advertiser or its agency. The Daily Edition reserves the right to reject, edit, or abbreviate any advertisement submitted. Advertising is accepted with the understanding that all liability for all copyright violations is the sole responsibility of the advertiser. Photographs, artwork and other copy submitted for publication is considered the sole property of the advertiser. The Daily Edition will make every effort but will not be liable for failure to publish and ad or for typographical and layout errors. All statements and information about highlights featured items, letters to the editor, herein are those solely given to the interviewer or writer and the Daily Edition assumes no responsibility of the accuracy or validity thereof. The Daily Edition will gladly reprint at no charge that part of an advertisement in which an error occurs provided a claim is made within 3 days of the first publication of the ad. Information contained in the Wazzup is received anonymously and the Daily Edition assumes no responsibility for information and reserves the right to edit or reject any and/or all submissions. The Daily Edition is a daily newspaper of general circulation in Loudon County defined under TCA 2-1-104(a)(13). The Daily Edition also serves Monroe, Knox, Anderson, Roane and Blount counties and serves 30,000 readers weekly. Send mail to PO Box 1240, Lenoir City TN 37771. 865-771-2249. email: dan1204us@yahoo.com The Daily Edition is Loudon County's premier public interest and paid advertising paper. The Daily Edition is produced and published daily Monday through Friday and is circulated throughout Loudon County and parts of Monroe and Knox Counties. Display advertising rates \$5.00 per column inch and quantity discounts available. Call for information on upcoming promotions and events.



HACIENDA Ayala's
Mexican Restaurant
 Market Dr. * Lenoir City (In Front of Food City)

Real Authentic Mexican Food at Affordable Prices

BEST MARGARITA

You've Tried The Rest
 Now Come Have The Best!!!

We Accept ALL Competitors Coupons Outside of Mexico City!

986-3553

Good Credit OK • Bad Credit OK • Bankruptcies OK • Repo OK



2010 Kia Soul Sporty, 4 cyl, Auto, PW, PL, A/C, Great On Gas, Like New



2011 Chevy Malibu 2LT, Loaded, Heated Seats, Leather, PS, PW, PL, Chrome Package

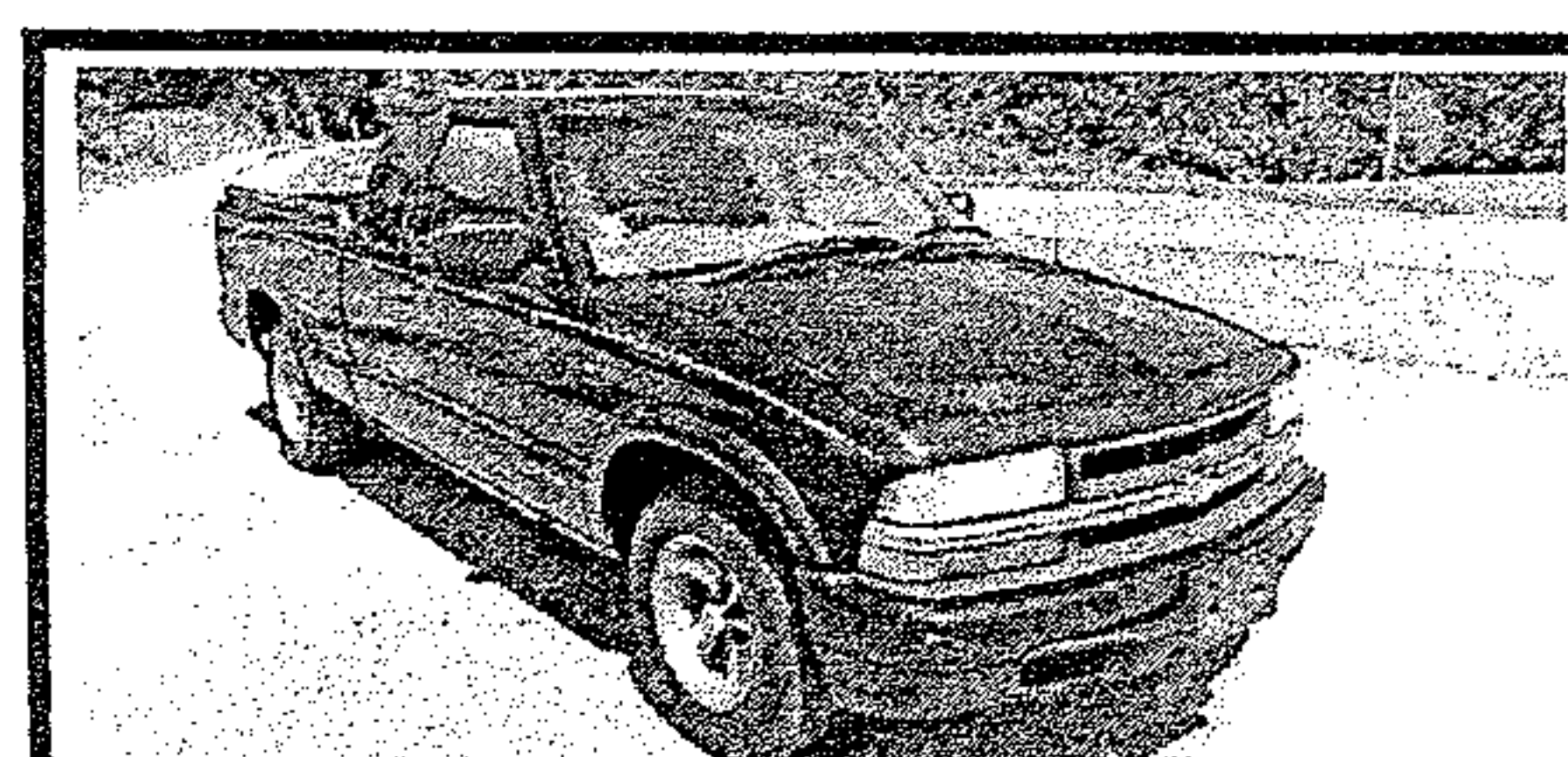

2000 Chevy S10- 4 Cyl, Auto, 3 Door, A/C, Tow Pkg

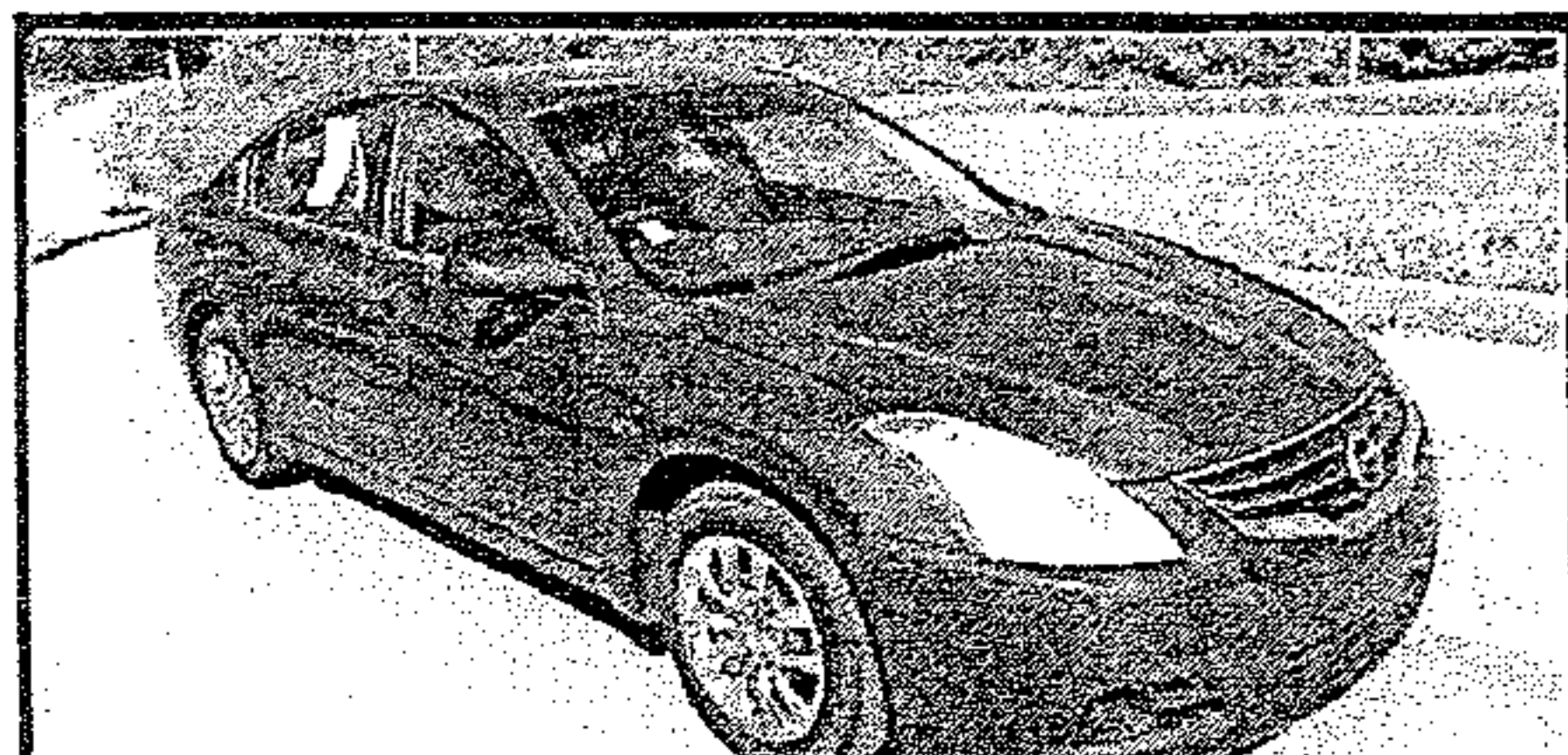

2010 Nissan Altima- GA\$ \$aver, Push Start, Chrome Wheels, PW, PL, A/C



2011 Hyundai Elantra- Leather, Sunroof, PW, PL, Immaculate Shape, LOW MILES 78K!!!



2013 Dodge Caravan SXT 86K, Power Doors, PW, PS, PL, Stow & Go

DEPENDABLE MOTORS 986-9343
 803 E. Broadway • Lenoir City

Serving Loudon County for 20 Years

* WAC. See Dealer for details

Visit our website at: www.dependablemotorslc.com

guilty

lowing incarceration, restitution, and fines. Pursuant to his plea agreement, Helton admitted to distributing and receiving child pornography via the Internet with peer-to-peer computer software. Helton also admitted to possessing in excess of 600 images of child pornography, including images of sadistic or masochistic conduct or other depictions of violence involving minors.

This investigation was conducted by the Knoxville Police Department's Internet Crimes Against Children Task Force, with assistance from the Federal Bureau of Investigation and the U.S. Homeland Security Investigations. Assistant U.S. Attorney Matthew Morris represented the United States.

This case was brought as part of Project Safe Childhood, a nationwide initiative to combat the growing epidemic of child sexual exploitation and abuse launched in May 2006 by the Department of Justice. Led by U.S. Attorneys' Offices and the

Criminal Division's Child Exploitation and Obscenity Section, Project Safe Childhood marshals federal, state and local resources to better locate, apprehend and prosecute individuals who exploit children via the Internet, as well as to identify and rescue victims. For more information about Project Safe Childhood, please visit www.projectsafechildhood.gov.

LCSO ctd. from pg. 2

bloody. Victim did have two small scratches on the right upper shoulder which appeared to be fresh and pinkish/red in color, and did appear to have some irritation

around the neck area. Mr. Upshaw was determined to be the primary aggressor in the incident and was placed under arrest and transported to the Loudon County Jail. Deputy Kevin Parks LCSO, made the arrest.

Campbell County Booster Club President Indicted for Theft

A special investigation by the Tennessee Comptrol-

ler's Office has found that April Griffie, president of the Campbell County High School Choral Booster Club, stole at least \$6,502 from the booster club.

The investigation found that Ms. Griffie stole cash, transacted checks, and used the booster club bank card for her personal benefit.

The theft also includes a \$1,450 embroidery machine (see indicted ctd. pg. 5)

West End Storage & Warehouses
502 Ward Avenue • Loudon
Call 865-458-4774 or 865-679-5555

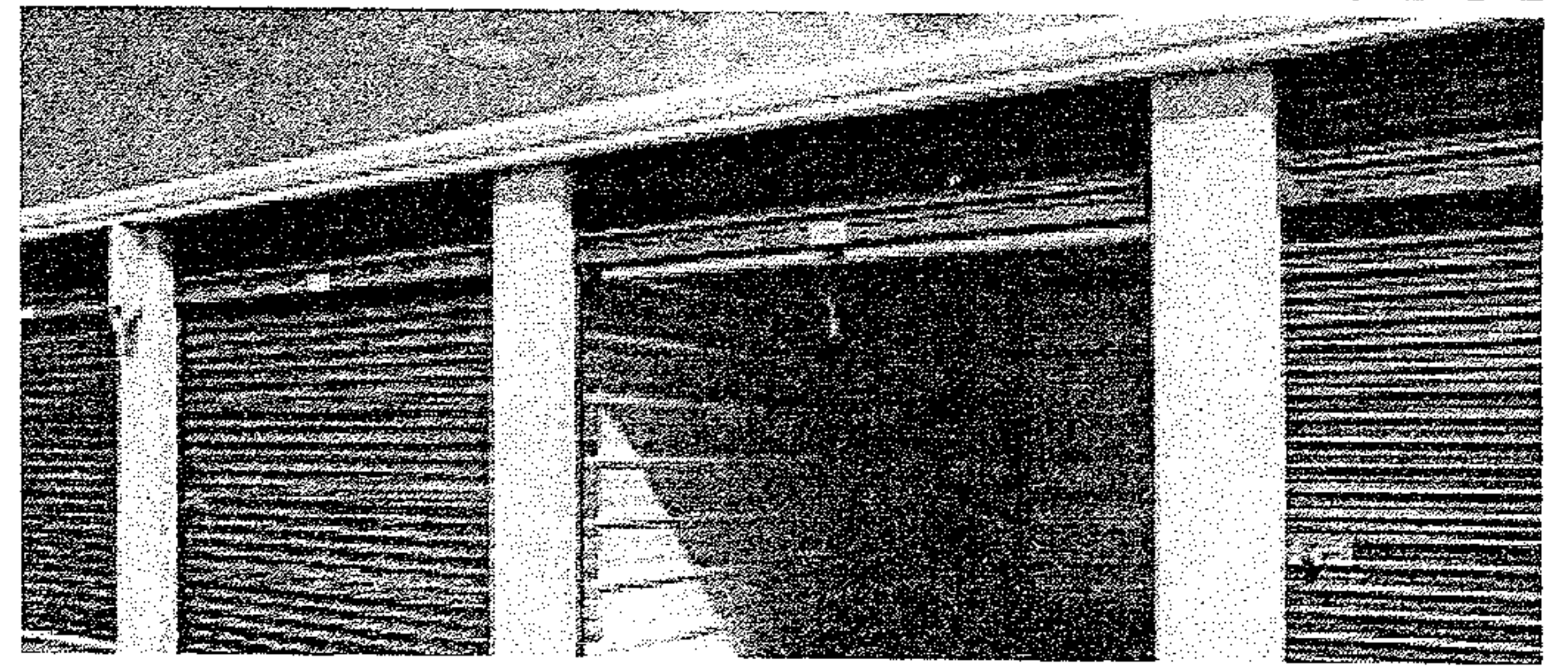

For Sale: Oak Wood Mulch



Mushroom Compost Topsoil.





Call Steve Spoon 986-4282

C&J Towing and Recovery
LOWEST TOWING RATES AROUND!!!

Have you been overcharged for any type of towing service in the Lenoir City area? If you have a breakdown or accident please OWNER REQUEST C&J Towing with the officer. Also please call your Sheriff and ask him to place C&J Towing on the "Rotation List*" and help other motorists save as much as you did! We at C&J are locally owned and operated, State approved, licensed, bonded and insured.

*note: the "Rotation List" is a list of wrecker services that provide service for wrecks, DUI's, breakdowns, etc. and are on an on-call basis for service. This list is approved by the Sheriff.

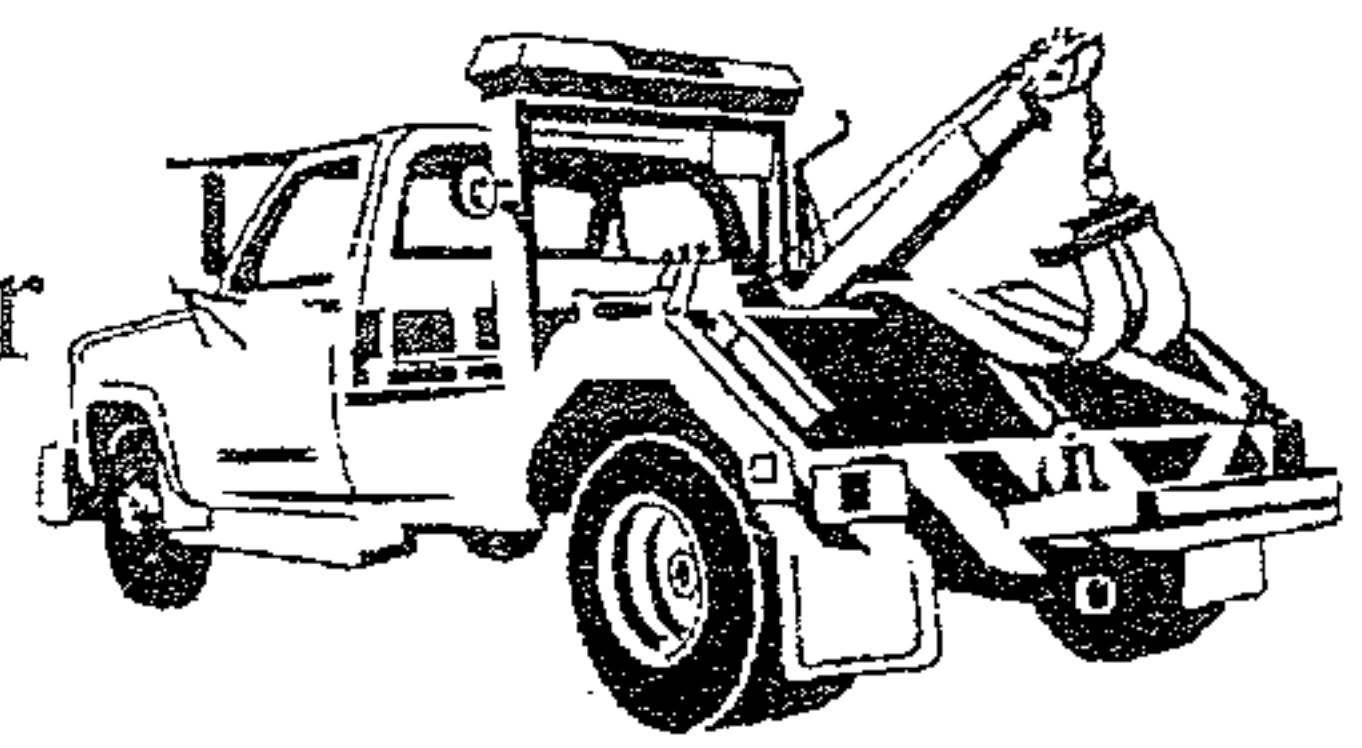
Cliff Teeters • Owner
865-809-1661

BIMBO'S
Deli Open 24 Hours
865-986-9643 Call Ins Welcome
Specials
Lg. Cold Sub, bag of chips and 16 oz. fountain drink only \$6.29
Footlong Corn Dog \$2.59

shooting

Frank Bristow, 60, Cheeskogili Way Loudon, was charged with Reckless Endangerment.

Kevin Fann, 34, Dunkirk Drive Maryville, was charged with Unlawful carrying or possession of a Handgun, and Simple Possession.

On 10/19/15 Deputy Billy Lewis LCSO, was dispatched to Cheestana Way for vandalism to a back door. Deputy made contact with the victim who stated that after

she and her husband arrived home her husband noticed that the glass in the door was broken. Upon further investigation victim noticed a bullet hole in the interior wall just across from the door. Upon Deputy speaking with victims they stated that the neighbor heard a gunshot between 12:00 and 13:00 hrs. on this date. The neighbor stated that the property owner on Cheeskogili Way had a 45 caliber handgun and is behind the victims home. Upon investigation by Investigator Ja-

son Smith LCSO, after evidence was collected it was possible that the round could have come from the house behind the victims. Two people was taken for questioning. After investigation was complete Frank Bristow and Kevin Fann was charged. Investigator Jason Smith LCSO, made the arrest.

Loudon County Sheriff's Office Toys for Tots 2015

Thanks to the generosity year after year of the Loudon County residents, churches, businesses and industries, the Loudon County Sheriff's Office is once

again able to offer the Toys for Tots program. We are beginning our 31st year of providing toys to the needy children of Loudon County, and thanks to generous contributions of time, money and gifts, we are able to make Christmas a more joyful time for more and more children. In 2014, approximately 500 children were helped by the Loudon County Sheriff's Department Toys for Tots program through their partners. Even with the difficult economic times we are experiencing, we hope that the people of Loudon County will

be there once again to help.

Names will be available beginning in mid-October through business and churches. If you are considering helping a child this Christmas, please be assured that applicants are thoroughly checked to make sure they require this assistance. Names are also compared with the school systems to make sure no one is receiving duplicate assistance.

If your business or church would be willing to take names please call Debbie Hines, Toys for Tots Coordinator at 986-4823.

Lenoir City Utilities Board Gas Department

Pilot Lighting Season 2015

**"Pilot Lighting Season" opens on October 1, 2015.
The cost for lighting a pilot light will be as follows:**

**1st Pilot Lighting, during normal work hours
No Charge**

**Pilot Re-lights, during normal work hours
\$25.00**

**After normal work hours/Holidays pilot lighting
\$141.56**

Please call 986-6591, ext. 1720, to make an appointment for this service.

**LCUB normal work hours are Monday – Friday,
7:00 am – 3:30 pm.**

SARCO Enterprises Inc. Offers Complete Home and Commercial Remolding and Repairs

Our Team members have a combined total of over 40 years experience in all areas of home construction, facilities maintenance and commercial construction. Roofing, Electrical, Bath and Kitchen Renovations, we do it all with just one call. We are fully insured and our work is guaranteed.

Call us today for a free no obligation quote for your next project.
865-809-9492.

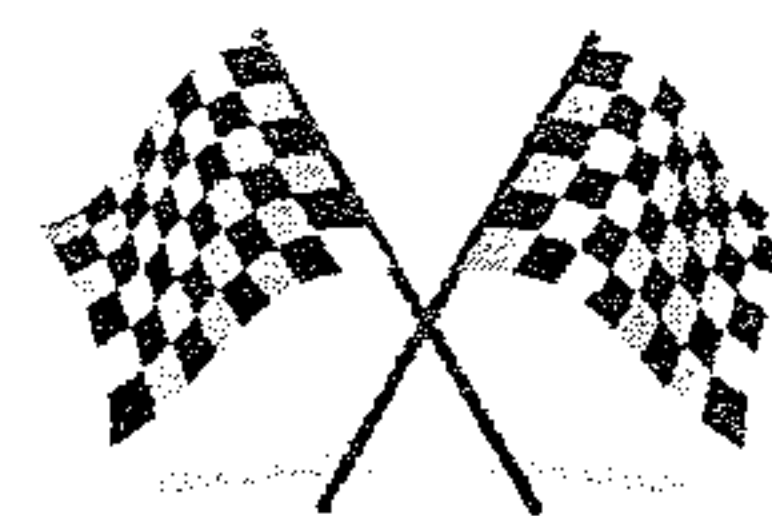

**SOUTHERN AUTO DETAILING
414 WEST BROADWAY
LENOIR CITY, TN 37771
865-986-0724**

**Starting at \$34.95
Present this ad for \$5.00 off**

Wilburn's

It's a Lenoir City institution, Wilburn's Hardware on Broadway in Lenoir City. When you need anything in the building business or home repair it's just "where ya go". The water cooler and rocking chairs still have story tellers daily around them. This time Wilburn's decided to say "Thank You" to a

community and its customers who have kept loyal over the years.

Owner Ed Shipley, who is always smiling anyway, was ever so thankful as he wandered around the crowd this past Thursday. Many locals came by to show their support, great seeing the world famous Joseph Wallace and even down to the cooking

done by local favorite Mike Cartwright just goes to show you the overwhelming support

Wilburn's has.

Thanks Ed Shipley and all the crew at Wilburn's Hardware!!!



Enjoying just another great day at Wilburn's

indicted ctd. from pg. 3

that Ms. Griffie purchased in September 2014 using booster club funds. Ms. Griffie used the machine to create customized shirts for choral students, and then, in February 2015, sold the machine and kept the proceeds.

Ms. Griffie admitted to investigators that she had used some booster club funds for her personal purchases. In October 2015, April Griffie was indicted by the Campbell County Grand Jury on one count of theft over \$1,000.

"Booster clubs create an opportunity for theft when they allow one person to control all financial activities without oversight," Comptroller Justin P. Wilson said. "State law requires school support organizations to adopt basic checks and balances to safeguard money."

School support organizations can learn more about these requirements by reviewing the Model Financial Policy for School Support Organizations on the Comptroller's website.

To view the special investigation online, go to: <http://www.comptroller.tn.gov/ia/>.

Wanted

Looking for a person interested in covering events in and around Loudon County. Must have license, own transportation, a computer or equivalent and can write.

Call Dan at 771-2249 to set up an interview.

PURDY'S AUTO PARTS AND SALVAGE

WE BUY SCRAP IRON • COPPER • BRASS • ALUMINUM

\$
Paying Top \$\$\$
Call For Latest Prices

You Name It, We Buy It!

Radiators, Wheels, Batteries, Appliances, Farm Equipment

Copper

Paying Top \$\$\$
Call For Latest Prices

You Call We Haul!

423-519-5402

* Prices subject to change with the market.



423 337-3977

149 County Road 323 Sweetwater

Complete Cars
per 100 lbs.

Scrap Metal

Paying Top \$\$\$
Call For Latest Prices
per 100 lb

We Buy Batteries

Aluminum Cans

Paying Top \$\$\$
Call For Latest Prices

Now Selling
Aftermarket
Body Parts at
Discount Prices

* Prices subject to change with the market.

bust

Christopher Carroll, 33, Boofer Road Georgia, was charged with Violation of Probation Man/Sell/Poss. of Controlled Substance, and Poss. of Drug Para.

Dennis Clark, 28, Bingham Lane Maryville, was charged with Man/Sell/Poss. of Controlled Substance, Poss. of Drug Para., Poss. of a Firearm in a Dangerous Situation,

and Assisting other Agency.

Jennifer Wilson, 37, East 40th Street Chattanooga, was charged with Man/Sell/Poss. of Controlled Substance, and Poss. of Drug Para

Richard Rush, 29, Taylor Street Chattanooga, was charged with Assisting other Agency, Criminal Impersonation, Man/Sell/Poss. of Controlled Substance, Poss. of Drug Para., Simple

Possession, Poss. of Burglary Tools, and Poss. of a Firearm in a Dangerous Situation.

Deputy Kevin Dailley LCSO, observed a white 2006 Chevrolet Impala traveling on Sunnyside Rd a known drug area with multiple occupants in the vehicle previous in the day when Deputy observed it again, at that

time Deputy ran the tag and it came back to a 1999 Ford truck. A traffic stop was initiated at Sunnyside Rd where Deputy came in contact with the driver Dennis Clark, front passenger Richard Rush, backseat passengers Jennifer Wilson, and Christopher Carroll. After attempting to get all occupants identification the Mr. Rush identified himself as Robert with dob as 7-85, after numerous failed attempts Mr. Rush was detained until Deputy could identify him. Deputy then had the driver detained due to getting an active warrant out of Monroe County, Tn, the back passenger Mr. Carroll was taken into custody

after having a warrant out of Georgia. Mr. Rush at this time advised Deputy who in fact he was where he also had a warrant out of Georgia. After having 3 subjects in custody Deputy noticed what appeared to be marijuana at the passenger door where Mr. Rush advised it was his. After a search of the vehicle items located are as follows: 4 digital scales (2 in blk bag center console and 2 in suitcase), 9mm handgun (drivers side center console), 6 needles (3 in trunk and 3 under rear seat), \$733.00 in cash(blk bag center console), Meth pipe(center

see bust ctd. pg. 8



Richard Rush

Public Notice

The County Corrections Partnership Committee will hold an open meeting at the Justice Center training room November 4, 2015 at 12 PM to discuss plans to move forward

LOOK! \$75 Weekly Payments LOOK!

MARTY'S AUTO SALES • 986-2222 • MARTY'S AUTO SALES • 986-2222 • MARTY'S AUTO SALES • 986-2222 • MARTY'S AUTO SALES • 986-2222 • MARTY'S AUTO SALES • 986-2222

Bad Credit
Divorce
Fixed Income
Repos
Bankruptcy
No Credit



APPROVED!

NO CREDIT CHECKS

Visit Us On The Web At:
martysautosales.net

\$499 down*

07 Cobalt, 5spd, gas saver, runs great Only \$499 down*

\$499 down*

00 130, Loaded, Lthr, Sunroof Only \$499 down*

\$499 down*

04 Cavalier, 2dr, Sporty, Only \$499 down*

\$499 down*

01 Sebring 2dr. sporty, Only \$499 down*

\$499 down*

01 Passat, Turbo, 5 speed Only \$499 down*

\$499 down*

03 Focus 5 speed, Gas Saver Only \$499 down*

\$499 down*

04 Optima, Runs Great LX V6, Only \$499 down*

\$499 down*

00 Ram, High Top Conversion Van, Loaded only \$499 down*

NO Credit Checks

Marty's Auto Sales 986-2222

100% Approval*

*See Dealer for details. All down payments plus tax, tag, title and fees.

MARTY'S AUTO SALES • 986-2222 • MARTY'S AUTO SALES • 986-2222 • MARTY'S AUTO SALES • 986-2222 • MARTY'S AUTO SALES • 986-2222 • MARTY'S AUTO SALES • 986-2222

Bust ctd. from pg. 7

console), lock picking set (suitcase in trunk) and a silver cylinder with Meth residue (center console). Also, Narcotics Officer S. Ezell arrived on scene where he measured and tested 4 bags of Meth with a total of 40.14 gm where it was located inside the black bag center console. The marijuana that

was located inside the vehicle measure out to 1.62 gm. All subjects were taken into custody, while all occupants stated that none of the drugs was theirs nor the paraphernalia.

All were transported to Loudon County Justice Center without incident.

Deputy Kevin Dailey LCSO, made the arrest.

A Name You Already Know And Trust Just Got Even More Dependable
DEPENDABLE AUTO SERVICE, LUBE AND TIRES
is Now Offering
Expert, Affordable Transmission Service

All ASE Certified Technicians

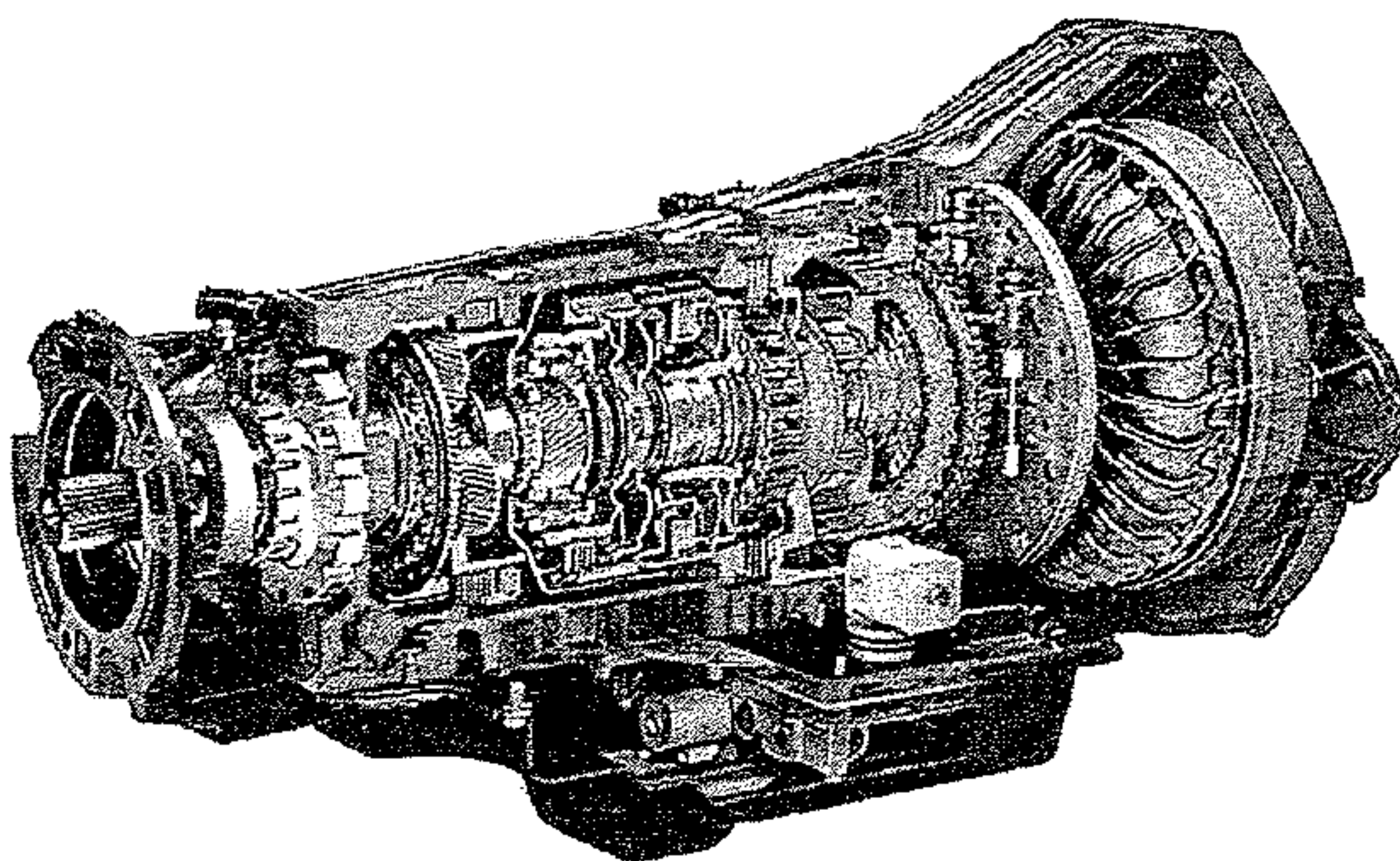

We proudly welcome all New Customers and Former Advanced Transmission Customers with a 10% Discount and Any Transmission Service or Repair*

865-986-9359

865-986-5050

LONNIE JONES
OPTICAL DISPENSARY

"We Make The Difference You Can See"
 Locally Owned and Operated

Over 1000 Frames To Choose From
 No Frame Over \$69.00



On the corner of A & Depot Street, Lenoir City

986-7803

Serving Loudon County for over 40 years

Bad Credit, No Credit OK!!! We Finance Everybody!!!

Low Down Payment!!!

Over 100 Cars, Trucks & Vans in Stock - Warranties On ALL Vehicles Sold!!!

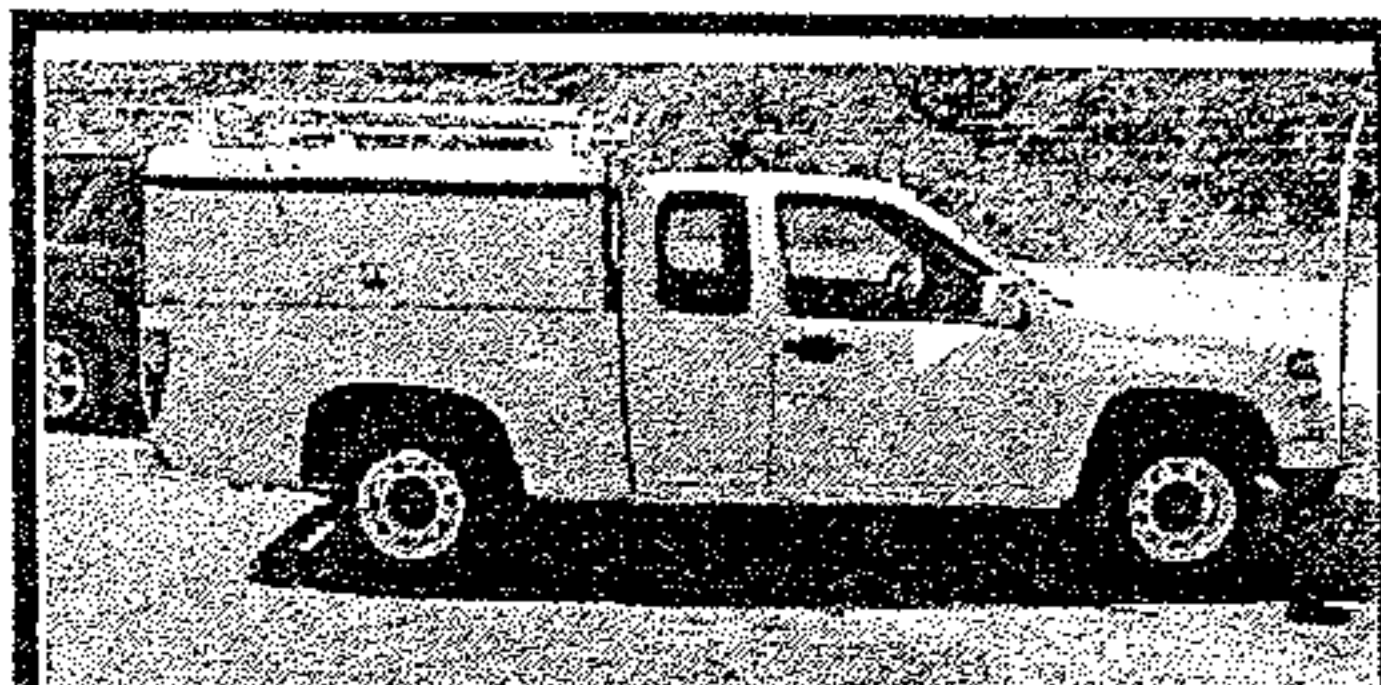

2009 Chevy Work Truck, Nice, lots of storage



2009 Nissan Cube, 66k miles, Great Gas Saver,



2006 Rendevous, 128k miles, leather, 3rd row seat



2006 Chrysler 300, Loaded, Nice Ride



2005 Dodge Dakota, 4dr, 4x4, Extra Clean, lots of room

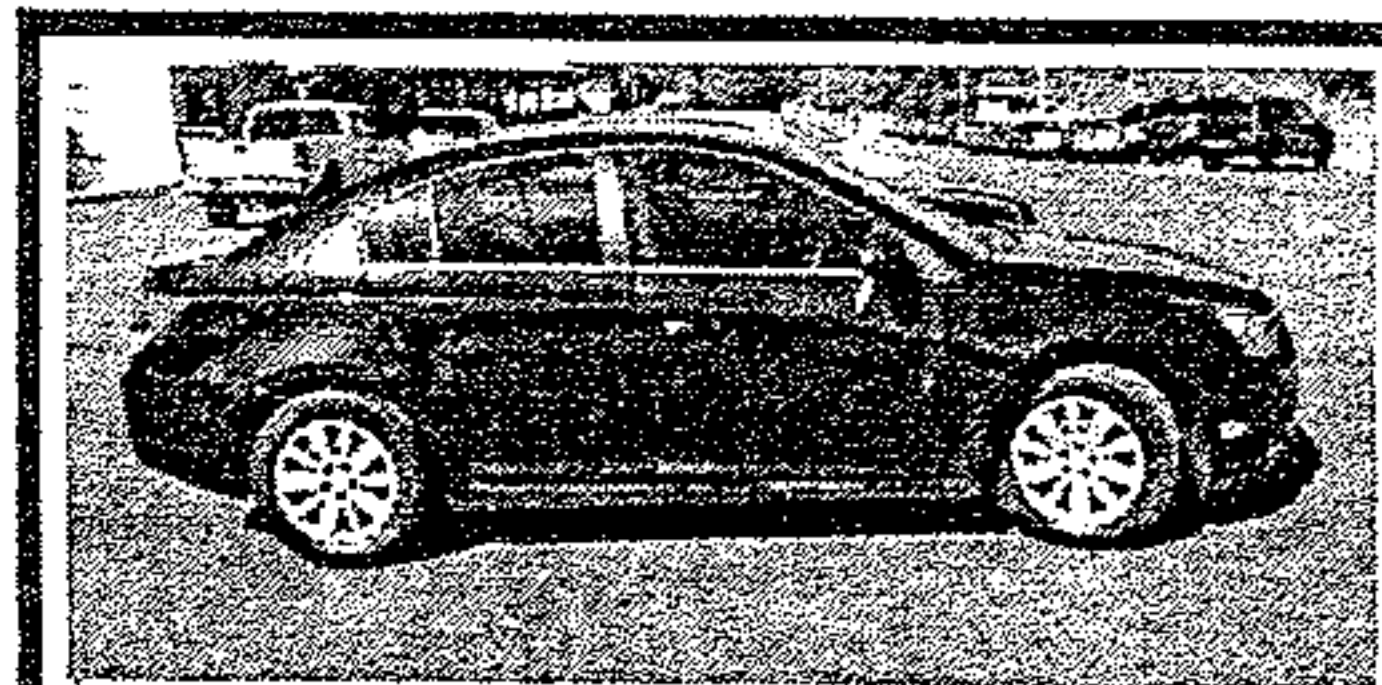

2011 Chevrolet Cruze, 55k miles, LOADED!!!



2003 Chevy Trailblazer, 93k miles, Extra Clean



2006 GMC 1500 Ex. Cab, 101k miles, Clean ride

WALT WILLIAMS, INC.

*with approved credit

3003 Highway 11

Lenoir City, TN

865-986-1111