

The Daily Edition

50¢

Serving Loudon, Monroe and Surrounding Counties

Monday, October 19, 2015

LCSO stops possible shooting; Armed Stalker Charged

The Loudon County Sheriff's Department possibly stopped what had the potential to be a very deadly scene. Two neighbors from Roane County have had a continual battle going on for years. It was not stated on the report if Roane County Sheriff's Office has made any arrests in the case only reports from 2013 to present.

(see Stalker pg. 7)



Michael McGrail



(see Contributing pg. 5) John McGrath

The Roadblock will get ya!



David Wells

(see roadblock pg. 4)

Attempt to take extra stuff at Walmart don't work



Jessica Shultz

(see Theft pg. 2)

Race and Law Enforcement Director Urges Closer Ties Between Police, Communities

FBI Director James Comey is continuing to urge police agencies and their constituents—particularly in communities of color—to take steps to better understand one another to help stem what he sees as a growing disconnect. "I imagine two lines," Comey said Thursday during a forum at Cuyahoga Community College in Cleveland, Ohio that included local law enforcement, community leaders, prosecu-

tors, and high school students. "One [line] is us in law enforcement and the other is the folks we serve and protect. And I think those two lines are arcing away from each other." The Director's remarks echoed a speech he delivered on the subject of race and law enforcement last February at Georgetown University in Washington, D.C. The speech followed lethal police encounters that occurred the previous summer in Ferguson, Missouri and New

(see FBI pg. 3)

Verse of the Day

I tell you the truth, anyone who gives you a cup of water in my name because you belong to Christ will certainly not lose his reward. — Mark 9:41

Obituaries

see inside **Wazzup** Looks like the warmer weather is finally leaving us, it's gonna be a cold one for sure. Enjoy the colors while

they last!

Weather

Today: Sunny skies. High 66F.
Tonight: Clear skies. Low around 40F.
Tuesday Sunny skies. High 69F.
Tuesday Night Partly cloudy. Low 44F.

Horoscopes

Libra 9/23-10/22

Your obsessive interest in getting to the bottom of a mystery might be a bit too intense for everyone else today. You want answers and you are pre-

(Continued on page 6)



Theft

Jessica Schultz, 25, Old Sweetwater Road Sweetwater, was charged with Theft of Property. Jessica was observed at Walmart Loss Prevention, check herself out in the self checkout. Jessica was observed scanning some items and placing some un-scanned items in a bag. Jessica did take the un-

scanned items and exit the store. Officer Keith Sennett LCPD, made the arrest.

Solicitor charged

Mihai Velcu, 28, Round Road Baltimore, was charged with Solicitation. Officer Brandon Gentry LCPD, was dispatched to the area of Walmart in reference to suspicious people. When Officer arrived he came in con-

tact with Mihai Velcu, who was holding sign asking for money and food. Mihai does not have a permit from the city to be soliciting. Mihai was placed under arrest. Officer Brandon Gentry LCPD, made the arrest.

Call 865-771-2249 to Advertise and start saving today! Has your group got an event coming up? Let us know!!!

Notice: The Daily Edition does not knowingly accept fraudulent or misleading materials. The Daily Edition cannot guarantee the validity of offerings or statements contained herein. All liability for the contents of all advertising, and for any claims that may arise therefrom, is the responsibility of the advertiser or its agency. The Daily Edition reserves the right to reject, edit, or abbreviate any advertisement submitted. Advertising is accepted with the understanding that all liability for all copyright violations is the sole responsibility of the advertiser. Photographs, artwork and other copy submitted for publication is considered the sole property of the advertiser. The Daily Edition will make every effort but will not be liable for failure to publish and ad or for typographical and layout errors. All statements and information about highlights featured items, letters to the editor, herein are those solely given to the interviewer or writer and the Daily Edition assumes no responsibility of the accuracy or validity thereof. The Daily Edition will gladly reprint at no charge that part of an advertisement in which an error occurs provided a claim is made within 3 days of the first publication of the ad. Information contained in the Wazzup is received anonymously and the Daily Edition assumes no responsibility for information and reserves the right to edit or reject any and/or all submissions. The Daily Edition is a daily newspaper of general circulation in Loudon County defined under TCA 2-1-104(a)(13). The Daily Edition also serves Monroe, Knox, Anderson, Roane and Blount counties and serves 30,000 readers weekly. Send mail to PO Box 1240, Lenoir City TN 37771. 865-771-2249. email: dan1204us@yahoo.com The Daily Edition is Loudon County's premier public interest and paid advertising paper. The Daily Edition is produced and published daily Monday through Friday and is circulated throughout Loudon County and parts of Monroe and Knox Counties. Display advertising rates \$5.00 per column inch and quantity discounts available. Call for information on upcoming promotions and events.

HACIENDA Ayala's
Mexican Restaurant
 Market Dr. * Lenoir City (In Front of Food City)

Real Authentic Mexican Food at Affordable Prices

BEST MARGARITA

You've Tried The Rest
 Now Come Have The Best!!!

We Accept ALL Competitors Coupons Outside of Mexico City!

986-3553



Good Credit OK • Bad Credit OK • Bankruptcies OK • Repo OK



2010 Kia Soul Sporty, 4 cyl, Auto, PW, PL, A/C, Great On Gas, Like New



2011 Chevy Malibu 2LT, Loaded, Heated Seats, Leather, PS, PW, PL, Chrome Package



2000 Chevy S10- 4 Cyl, Auto, 3 Door, A/C, Tow Pkg



2010 Nissan Altima- GA\$ \$aver, Push Start, Chrome Wheels, PW, PL, A/C



2011 Hyundai Elantra- Leather, Sunroof, PW, PL, Immaculate Shape, LOW MILES 78K!!!



2013 Dodge Caravan SXT 86K, Power Doors, PW, PS, PL, Stow & Go

DEPENDABLE MOTORS 986-9343
 803 E. Broadway • Lenoir City

Serving Loudon County for 20 Years

* WAC. See Dealer for details

Visit our website at: www.dependablemotorslc.com

Roadblock

David Wells, 27, Indian Ridge Way Sevierville, was charged with DUI, and Simple Possession. While performing traffic control on Hwy 95 and Morganton Road Deputy JC Schultz LCSO, observed a white vehicle drive up where Deputy was standing, roll down his window and the odor of alcohol and marijuana emitted from the vehicle. The vehicle was ask to pull over and the driver was identified as David Wells. David had

blood shot eyes and slurred speech. Deputy observed a half empty bottle of Crown Royal and Tequila lying in the driver side back seat. David was ask to exit the vehicle and perform sobriety test which he did poorly on. Deputy found a marijuana cigarette under the driver front seat. Deputy JC Schultz LCSO, made the arrest.

Loudon County Sheriff's Office Toys for Tots 2015

Thanks to the generosity year after year of the Loudon County residents, churches, businesses and industries, the Loudon County Sheriff's Office

is once again able to offer the Toys for Tots program. We are beginning our 31st year of providing toys to the needy children of Loudon County, and thanks to generous contributions of time, money and gifts, we are able to make Christmas a more joyful time for more and more children. In 2014, approximately 500 children were helped by the Loudon County Sheriff's Department Toys for Tots program through their partners. Even with the difficult economic times we are experiencing, we hope that the people of Loudon County will be there once again to help. Beginning Tuesday, September 8, the

2015 applications will be available at the Loudon County Sheriffs Office. Applications will be accepted for children from Age 1 through 8th grade that are enrolled in the Loudon County or Lenoir City School systems. ALL applications must be returned to the Loudon County Sheriff's Department by 4 PM, THURSDAY, OCTOBER 22, 2015. It is requested that everyone please submit their application as soon as possible. Applications must also include a copy of the parent or guardian's current income information. A current Tennessee Driver's License or State

Issued ID is required from the parent, and a copy of the child's social security card is also required.

Names will be available beginning in mid-October through business and churches. If you are considering helping a child this Christmas, please be assured that applicants are thoroughly checked to make sure they require this assistance. Names are also compared with the school systems to make sure no one is receiving duplicate assistance.

If your business or church would be willing to take names please call Debbie Hines, Toys for Tots Coordinator at 986-4823.

Lenoir City Utilities Board Gas Department

Pilot Lighting Season 2015

**"Pilot Lighting Season" opens on October 1, 2015.
The cost for lighting a pilot light will be as follows:**

**1st Pilot Lighting, during normal work hours
No Charge**

**Pilot Re-lights, during normal work hours
\$25.00**

**After normal work hours/Holidays pilot lighting
\$141.56**

Please call 986-6591, ext. 1720, to make an appointment for this service.

**LCUB normal work hours are Monday – Friday,
7:00 am – 3:30 pm.**

SARCO Enterprises Inc. Offers Complete Home and Commercial Remolding and Repairs

Our Team members have a combined total of over 40 years experience in all areas of home construction, facilities maintenance and commercial construction. Roofing, Electrical, Bath and Kitchen Renovations, we do it all with just one call. We are fully insured and our work is guaranteed.

Call us today for a free no obligation quote for your next project.
865-809-9492.

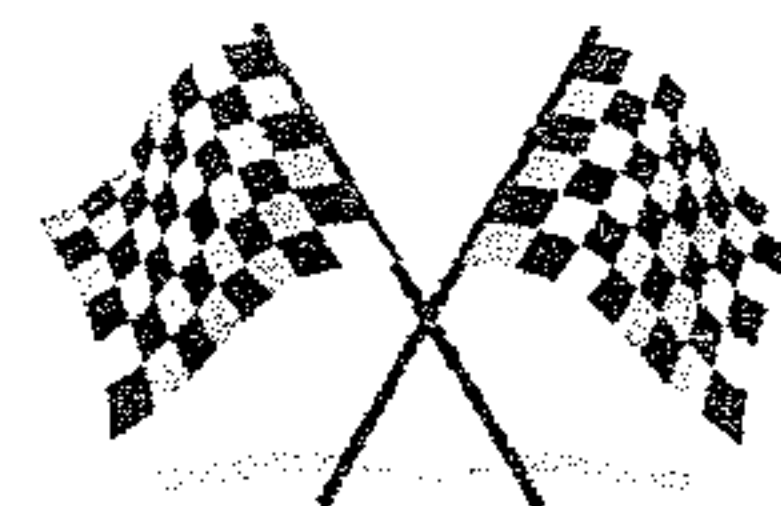

SOUTHERN AUTO DETAILING

**414 WEST BROADWAY
LENOIR CITY, TN 37771**

865-986-0724

**Starting at \$34.95
Present this ad for \$5.00 off**

FBI

York City—sparking protests and intense public debate—and the apparent retribution killings of two uniformed New York Police Department officers in December 2014.

At the time, Comey suggested his remarks were only the beginning of a broader and much-needed exchange on the subject. “These are only conversations in the true sense of that word if we are willing not only to talk but to listen, too.”

In the months since then, the Director has continued to talk on the subject and FBI field offices around the country have reached out to their own communities to further that conversation as well.

In Cleveland, where violent crime rates have risen dramatically this year, Director Comey joined Cleveland Police Chief Calvin Williams, Cuyahoga County Sheriff Clifford Pinkney, and more than 200 members of the local community to talk and to listen.

“I’m here because I think Cleveland is a place of great pain that is in a way illustrative of that crisis of those bending arcs,” Comey said.

It was in Cleveland that a 12-year-old African-American boy, Tamir Rice, was fatally shot by a police officer while holding a pellet gun in November 2014. The city is implementing a federal agreement following a Department of Justice determination last year that city police officers too

often used excessive force and violated people’s civil rights. A provision of the settlement is to better train officers in community engagement.

During the question-and-answer-style forum, moderated by FBI Cleveland Special Agent in Charge Stephen Anthony, the panelists agreed that a major step forward would be for police to get out of their cars and get better acquainted with people in their communities. But the hard work has to be shared, they said. “For law enforcement to be successful—to make a better community—we need your help,” Sheriff Pinkney told attendees, including some 40 young students seated in the front rows. “We need your support, whether it’s publicly or anonymously—we need you to be a part of this team.”

Comey said the answer to find-

ing more common ground was “unscientific.” “It’s simply understanding that it’s hard to hate up close,” Comey said. “We must see each other more clearly.”

In the audience, Ryan Hurley, a humanities teacher at St. Martin de Porres High School, listened with interest, alongside a dozen of his students.

“We’re having this conversation in our classes, we’re having this conversation in our school because it’s important,” Hurley

said following the event. “I think the big takeaway is that it’s sort of a shared responsibility. And they’re okay taking on that responsibility if they feel like they have trust in the people at the top.”

After the forum, Hurley asked students what they thought.

“Their first response was, ‘They seem a lot different here than they do on the news.’”

Cleveland Police Chief Williams was optimistic that things were

(see FBI ctd. pg. 8)

For Sale: oak Wood Mulch



Mushroom Compost Topsoil.



Firewood

Call Steve Spoon 986-4282

West End Storage & Warehouses
502 Ward Avenue • Loudon
Call 865-458-4774 or 865-679-5555

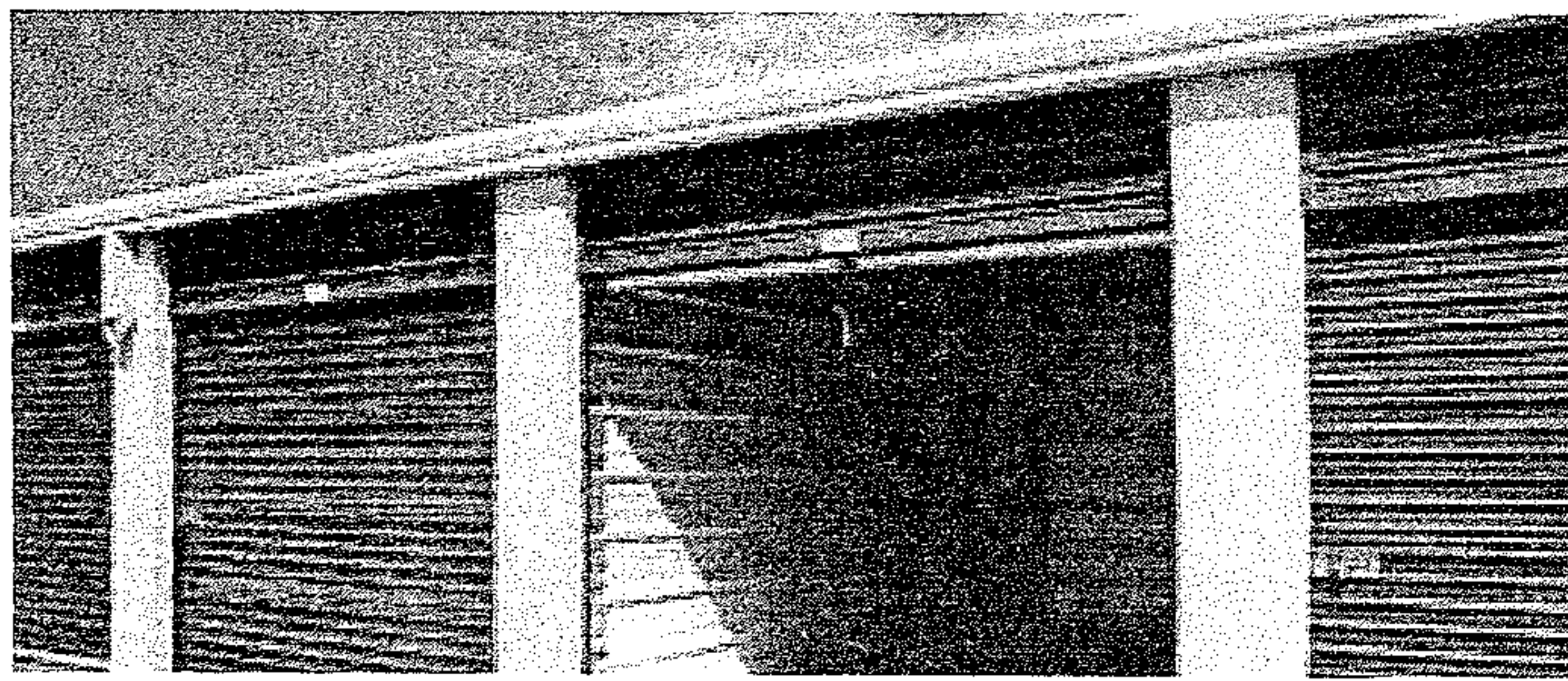

C&J Towing and Recovery
LOWEST TOWING RATES AROUND!!!

Have you been overcharged for any type of towing service in the Lenoir City area? If you have a breakdown or accident please **OWNER REQUEST C&J Towing** with the officer. Also please call your Sheriff and ask him to place C&J Towing on the “Rotation List*” and help other motorists save as much as you did! We at C&J are locally owned and operated, State approved, licensed, bonded and insured.

*note: the “Rotation List” is a list of wrecker services that provide service for wrecks, DUI’s, breakdowns, etc. and are on an on-call basis for service. This list is approved by the Sheriff.

Cliff Teeters • Owner
865-809-1661



BIMBO'S
Deli Open 24 Hours
865-986-9643 Call Ins Welcome

Specials

Lg. Cold Sub, bag of chips and 16 oz. fountain drink only \$6.29

Footlong Corn Dog \$2.59

Contributing

John McGrath, 23, Lake Drive Loudon, was charged with Contributing to the Delinquency of Minor. Officer Tyrel Lorenz LCPD, conducted a traffic stop on a Nissan on Broadway. Officer made contact with John McGrath who was a passenger in the vehicle that smelled heavily of burnt marijuana inside it. The

vehicle also contained 3 juveniles who were out past curfew. John stated that he had smoked marijuana. The juveniles were turned over to parents and John was placed under arrest. Officer Tyrel Lorenz LCPD, made the arrest.

Ads starting at only \$1 per day.
Call 865-771-2249

HEATHER MORGAN SENTENCED FOR MAKING FALSE STATEMENTS TO FEDERAL LAW ENFORCEMENT IN BREAKTHROUGH PAIN MANAGEMENT INVESTIGATION

On Oct. 13, 2015, Heather Morgan, 28, of Maryville, Tenn., was sentenced to serve 18 months in federal prison by the Honorable Thomas A. Varlan, Chief U.S. District Judge. Upon her release from prison, Morgan will serve a two year period of su-

pervised release.

Morgan pleaded guilty to a federal grand jury indictment charging her with making false statements to a federal law enforcement agent. She admitted to lying to law enforcement regarding the location of customer files dur-

ing the investigation of the Breakthrough Pain Management Clinic (Breakthrough) in Maryville, Tenn.

The co-owners of Breakthrough, along with two family members, were previously convicted for their roles in operating the pain clinic and are currently serving prison terms. The pain clinic ceased operations after raids at several locations by federal and local law enforcement agents in December 2010, when agents seized significant quantities of prescription narcotic pain pills, firearms, and nearly \$700,000 in cash.

The investigation into the pill mill case was the collaborative effort of several law enforcement agencies including the Internal Revenue Service, Fifth Judicial Drug Task Force, and Drug Enforcement Administration. Assistant U.S. Attorney Jennifer Kolman represented the United States.

All About You Homecare LLC is now hiring experienced, dependable cna's and caregivers. must have clean background check, be available on week-ends and holidays, must have references, and be subject to random drug screenings. Contact Geneva at 865-237-1137 between 10am-4pm for more info

PURDY'S AUTO PARTS AND SALVAGE
WE BUY SCRAP IRON • COPPER • BRASS • ALUMINUM

\$ **Paying Top \$\$\$**
Call For Latest Prices

You Name It, We Buy It!

Radiators, Wheels, Batteries, Appliances, Farm Equipment

Copper
Paying Top \$\$\$
Call For Latest Prices

Complete Cars
per 100 lbs.

Scrap Metal
Paying Top \$\$\$
Call For Latest Prices
per 100 lb

We Buy Batteries

Aluminum Cans
Paying Top \$\$\$
Call For Latest Prices

Now Selling Aftermarket Body Parts at Discount Prices

You Call We Haul!
423-519-5402

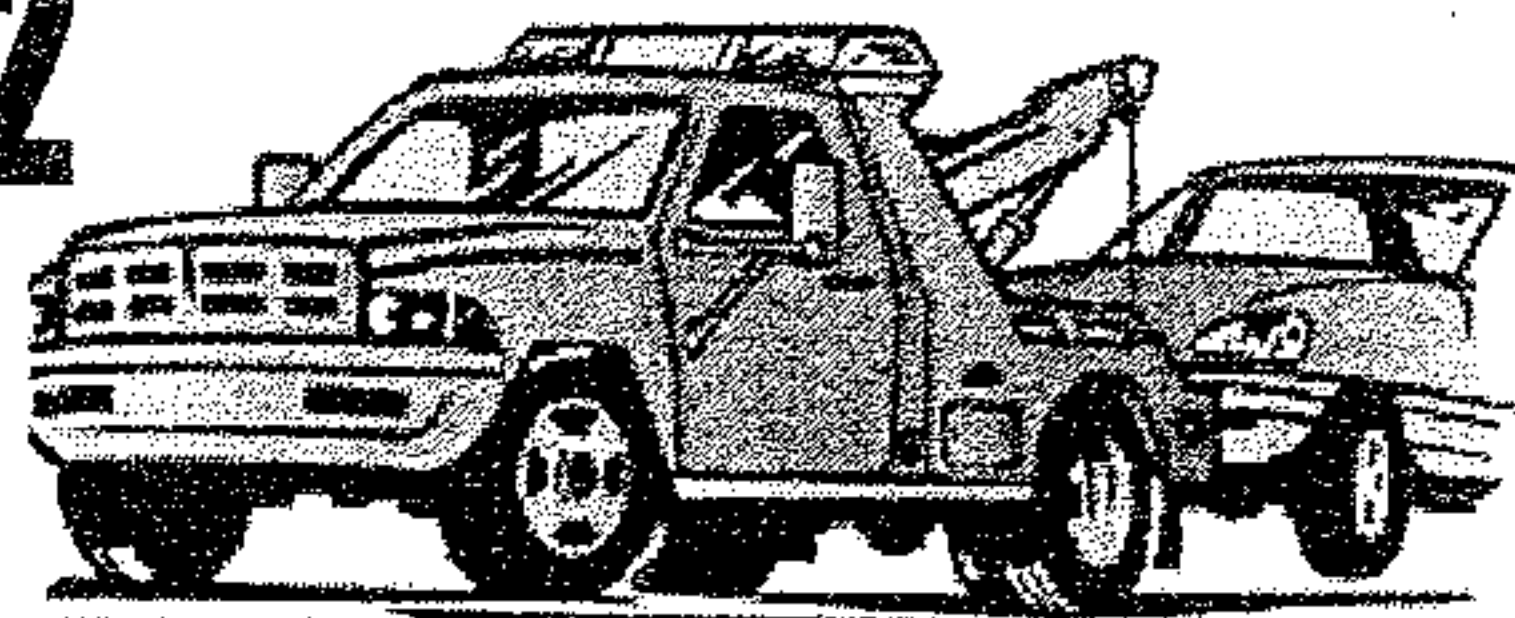

* Prices subject to change with the market.

423 337-3977
149 County Road 323 Sweetwater

Prices subject to change with the market.

Place Your Ad In The Daily Edition. Call 865-771-2249

Stalker

Michael McGrail, 56, Lakeshore Vista Kingston, was charged with DUI, Poss. of a Handgun while Under the Influence, and Stalking.

At approximately 6:22am Friday. Deputy Robbie Lane LCSO, was dispatched to Hwy 70 West for a caller who advised a male was following him and had threatened him last night. Deputy Lane responded to Hwy 70 West and dispatch advised that the complaint was driving a blue smart car and a white Ford F150 was following him from inside Roane County.

Dispatch advised Complainant had made it into Loudon County and the truck was still

following him. Deputy stopped and waited on the vehicle on Hwy 70 West and White Wing Rd. Victim pulled into parking lot and the white Ford attempted to pull in behind him and saw deputies car and turned onto White Wing Rd.

Deputy conducted traffic stop with the Ford on White Wing Rd. Deputy made contact with the driver Mr. Michael McGrail. Mr. McGrail had a strong odor of alcohol coming from his person red watery eyes slurred speech at the time of the stop. Dispatch advised that victim had informed them that Mr. McGrail had threaten him with a gun last night in Roane County.

Deputy asked Mr. McGrail if he had any weapons with him and he stated he had a handgun with him. Deputy removed Mr. McGrail out of the truck and escorted him to the front of his unit. Deputy searched Mr. McGrail and found in his right jacket pocket two 6 round magazines loaded 380 ammo. Deputy found in Mr. McGrail's left pants pocket two more 6 round magazines loaded 380 ammo. Deputy placed Mr. McGrail into hand cuffs until he could fine out what was going on. In the driver side door Deputy found a Smith & Wesson 380 Body Guard hand gun inside the truck. The hand gun had another 6 round magazine loaded

380 ammo inside but no round in the chamber. Victim advised that he has been threaten several times by Mr. McGrail in Roane County.

Dispatched called Roane County and they advised that they had several calls dating back to 2013 for Harassment and weapon issues between the two males and they are neighbors. Mr. McGrail was read his Miranda rights and he stated he would talk with Deputy without a Lawyer. Mr. McGrail advised he had dropped his wife off at work off of Sugar Limb Rd. Mr. McGrail stated he was on his way home when he passed victim on the road and turned around and followed victim.

Mr. McGrail advised

he wanted victim to know he was following him due to issues from the past. Victim advised he was in fear of his safety due to Mr. McGrail had threaten him with the gun last night. Mr. McGrail was given feild sobriety test . Mr. McGrail did poorly on all test given. Mr. McGrail advised he had drank a bottle of liquor last night around 2200 Hrs. Mr. McGrail was read the Implied Consent and did consent to blood test. Mr. McGrail was transported to Fort Loudon Jail and a BA was drawn. Mr. McGrail was transported to Loudon County Jail without incident. Deputy Robbie Lane LCSO, made the arrest.

LOOK!
\$75 Weekly Payments
LOOK!

MARTY'S AUTO SALES • 986-2222
MARTY'S AUTO SALES • 986-2222
MARTY'S AUTO SALES • 986-2222
MARTY'S AUTO SALES • 986-2222
MARTY'S AUTO SALES • 986-2222

Bad Credit

Divorce

Fixed Income

Repos

Bankruptcy

No Credit

APPROVED!

Visit Us On The Web At:

marty'sautosales.net

NO

CREDIT

CHECKS

\$499 down*

07 Cobalt, 5spd, gas saver, runs great Only \$499 down *

\$499 down*

00 I30, Loaded, Lthr, Sunroof Only \$499 down *

\$499 down*

04 Cavalier, 2dr, Sporty, Only \$499 down *

\$499 down*

01 Sebring 2dr. sporty, Only \$499 down *

\$499 down*

01 Passat, Turbo, 5 speed Only \$499 down *

\$499 down*

03 Focus 5 speed, Gas Saver Only \$499 down *

\$499 down*

04 Optima, Runs Great LX V6, Only \$499 down *

\$499 down*

00 Ram, High Top Conversion Van, Loaded only \$499 down *

NO

Credit Checks

Marty's

Auto Sales

986-2222

*See Dealer for details. All down payments plus tax, tag, title and fees.

100%

Approval*

MARTY'S AUTO SALES • 986-2222
MARTY'S AUTO SALES • 986-2222
MARTY'S AUTO SALES • 986-2222
MARTY'S AUTO SALES • 986-2222
MARTY'S AUTO SALES • 986-2222

FBI ctd. from pg. 3

beginning to change. His department, along with the FBI, recently held a "Safety in Your Sanctuary" program for about 40 local clergy members. Another recent community event focused on police use of force.

"I think that right now, this moment, we're at a point where we're going up," Williams said. "I think we're at a point where people are actually coming together to really

talk sensible solutions about things that are happening."

The Director said Cleveland was an ideal location to continue the discussion of race and law enforcement. "This is a place of tremendous promise," he said. "Given the quality of the leadership you have here and the folks here in this room, you actually have the best chance of arcing those lines back together and showing this country how it can be done."

A Name You Already Know And Trust Just Got Even More Dependable
DEPENDABLE AUTO SERVICE, LUBE AND TIRES
is Now Offering
Expert, Affordable Transmission Service

All ASE Certified Technicians

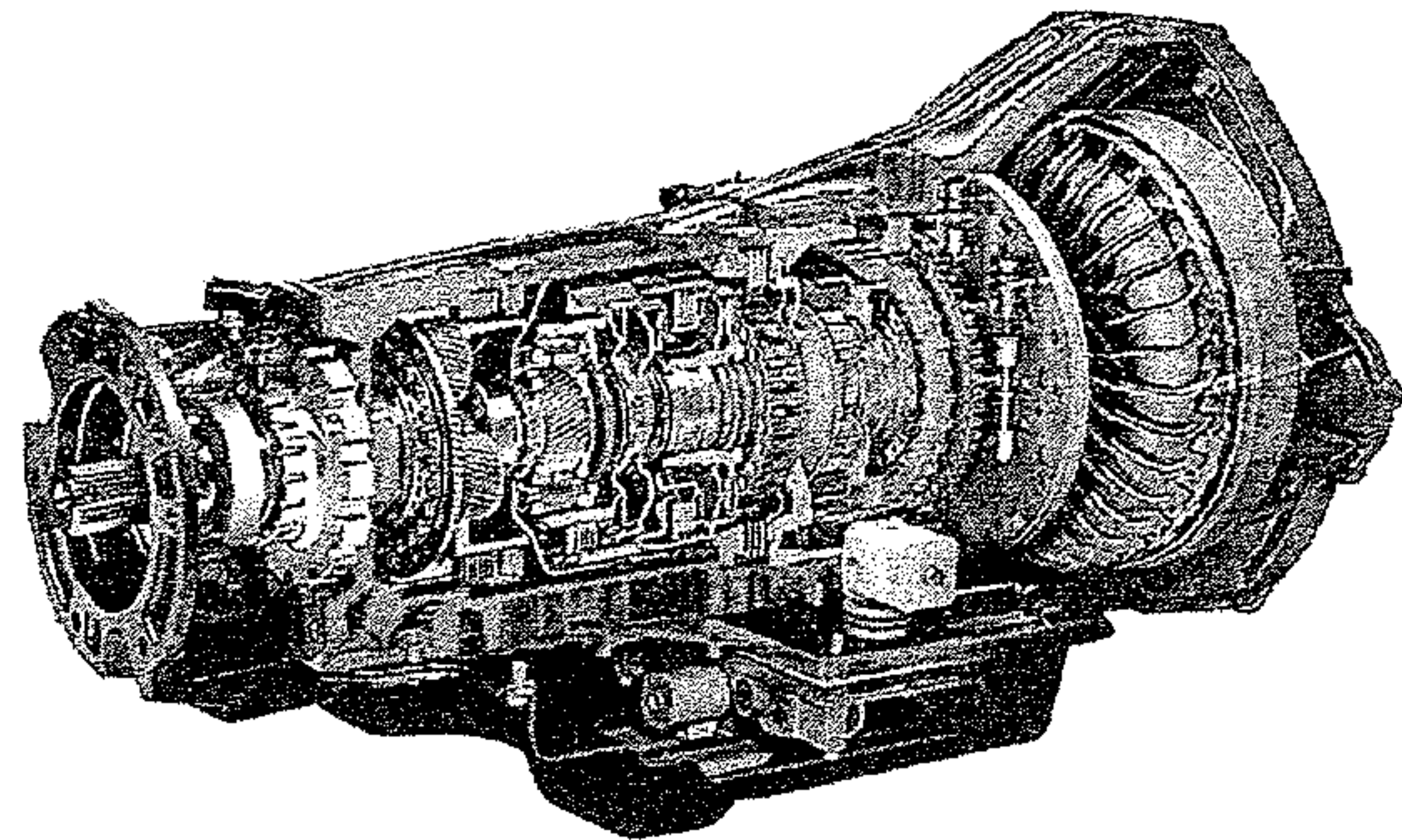

We proudly welcome all New Customers and Former Advanced Transmission Customers with a 10% Discount and Any Transmission Service or Repair*

865-986-9359

865-986-5050

LONNIE JONES
OPTICAL DISPENSARY

"We Make The Difference You Can See"
 Locally Owned and Operated

Over 1000 Frames To Choose From
 No Frame Over \$69.00



On the corner of A & Depot Street, Lenoir City

986-7803

Serving Loudon County for over 40 years

Bad Credit, No Credit OK!!! We Finance Everybody!!!

Low Down Payment!!!

Over 100 Cars, Trucks & Vans in Stock - Warranties On ALL Vehicles Sold!!!

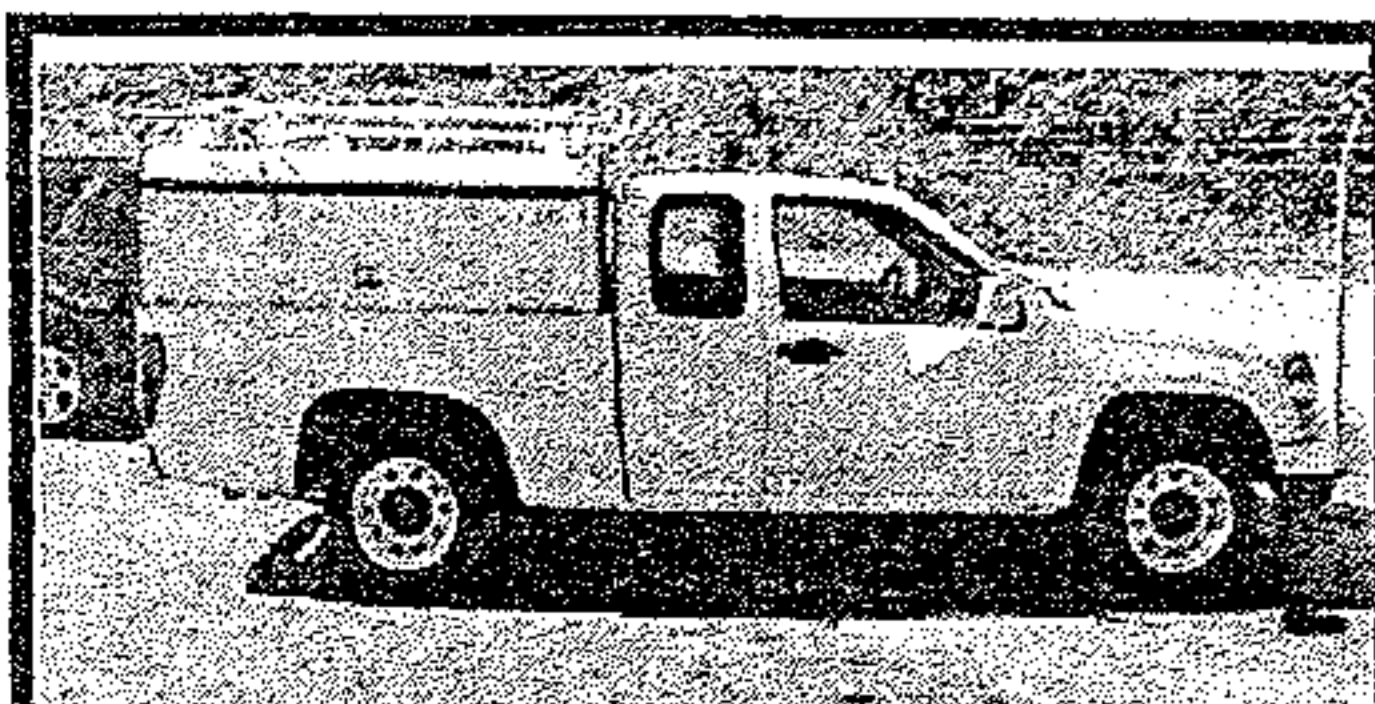

2009 Chevy Work Truck, Nice, lots of storage

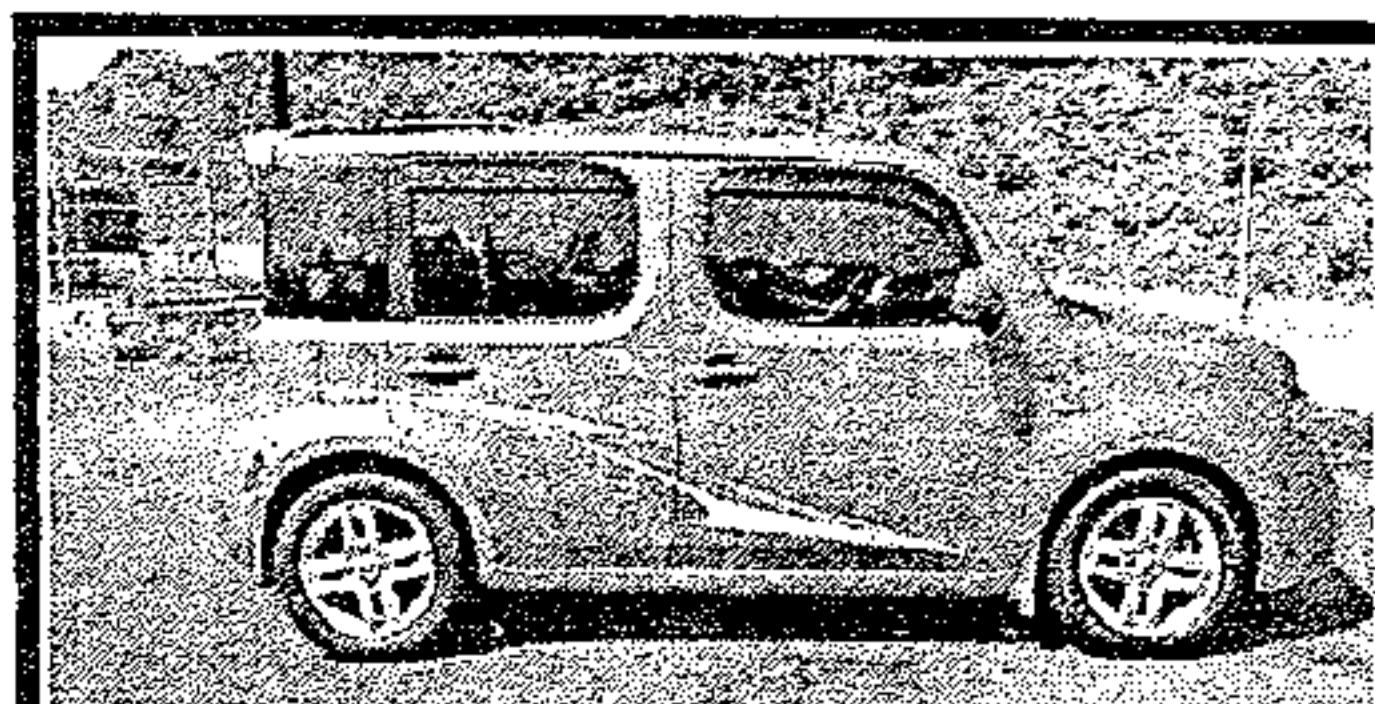

2009 Nissan Cube, 66k miles, Great Gas Saver,



2006 Rendevous, 128k miles, leather, 3rd row seat



2004 GMC Envoy, 3rd row seat, Extra Clean

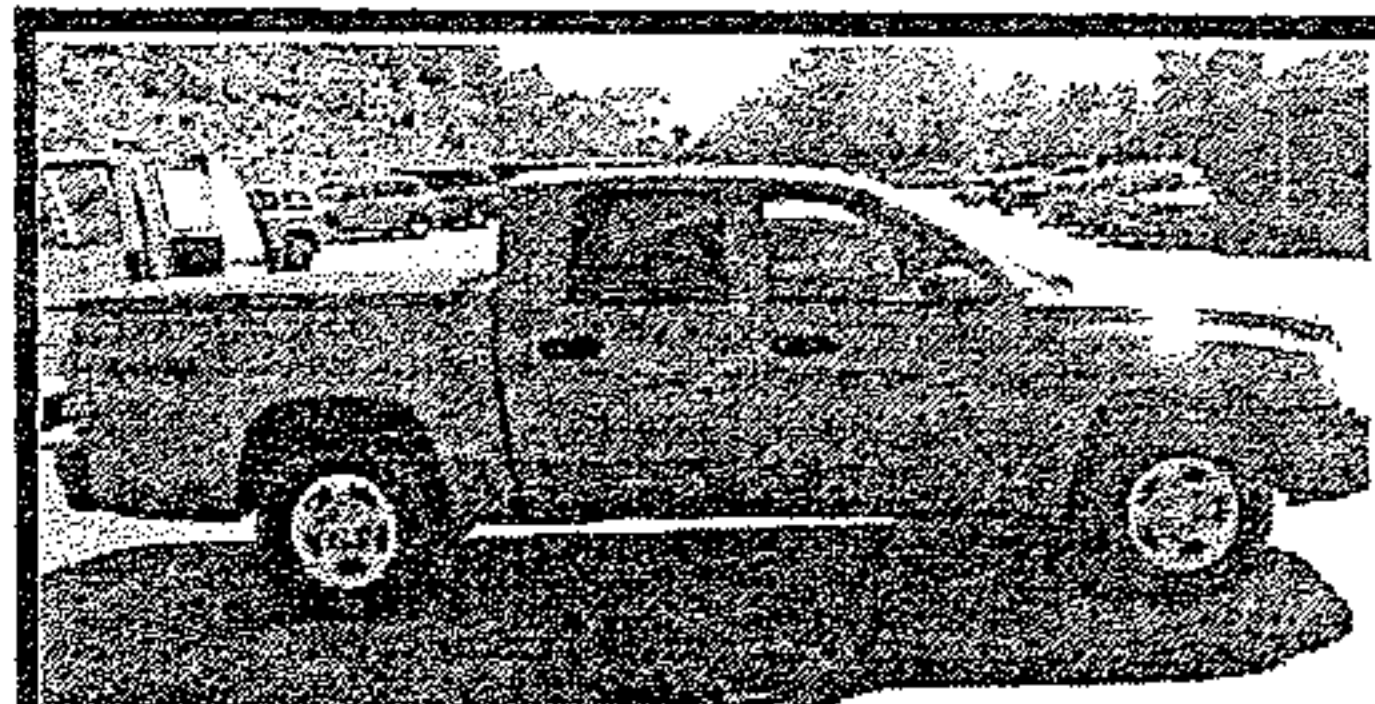

2005 Dodge Dakota, 4dr, 4x4, Extra Clean, lots of room



2012 Ford Escape, Clean, Great Gas MPG 109k miles



2003 Chevy Trailblazer, 93k miles, Extra Clean



2006 GMC 1500 Ex. Cab, 101k miles, Clean ride

WALT WILLIAMS, INC.

*with approved credit

3003 Highway 11 Lenoir City, TN 865-986-1111